

STATE OF NORTH CAROLINA  
DEPARTMENT OF TRANSPORTATION  
RALEIGH, N.C.

C203954

CONTRACT AND  
CONTRACT BONDS

FOR CONTRACT NO. C203954

WBS 50164.3.1 STATE FUNDED

T.I.P NO. U-5742

COUNTY OF CUMBERLAND  
THIS IS THE SIGNAL CONTRACT  
ROUTE NUMBER \_\_\_\_\_ LENGTH 0.000 MILES  
LOCATION FAYETTEVILLE - COMPUTERIZED TRAFFIC SIGNAL SYSTEM.

CONTRACTOR FULCHER ELECTRIC OF FAYETTEVILLE INC  
ADDRESS P.O. BOX 2799  
FAYETTEVILLE, NC 28302

BIDS OPENED FEBRUARY 21, 2017  
CONTRACT EXECUTION 3/24/2017

STATE OF NORTH CAROLINA  
DEPARTMENT OF TRANSPORTATION  
RALEIGH, N.C.

PROPOSAL

DATE AND TIME OF BID OPENING: **FEBRUARY 21, 2017 AT 2:00 PM**

CONTRACT ID C203954

WBS 50164.3.1

FEDERAL-AID NO. STATE FUNDED

COUNTY CUMBERLAND

T.I.P. NO. U-5742

MILES 0.000

ROUTE NO.

LOCATION FAYETTEVILLE - COMPUTERIZED TRAFFIC SIGNAL SYSTEM.

TYPE OF WORK SIGNALS.

**NOTICE:**

ALL BIDDERS SHALL COMPLY WITH ALL APPLICABLE LAWS REGULATING THE PRACTICE OF GENERAL CONTRACTING AS CONTAINED IN CHAPTER 87 OF THE GENERAL STATUTES OF NORTH CAROLINA WHICH REQUIRES THE BIDDER TO BE LICENSED BY THE N.C. LICENSING BOARD FOR CONTRACTORS WHEN BIDDING ON ANY NON-FEDERAL AID PROJECT WHERE THE BID IS \$30,000 OR MORE, EXCEPT FOR CERTAIN SPECIALTY WORK AS DETERMINED BY THE LICENSING BOARD. BIDDERS SHALL ALSO COMPLY WITH ALL OTHER APPLICABLE LAWS REGULATING THE PRACTICES OF ELECTRICAL, PLUMBING, HEATING AND AIR CONDITIONING AND REFRIGERATION CONTRACTING AS CONTAINED IN CHAPTER 87 OF THE GENERAL STATUTES OF NORTH CAROLINA. NOTWITHSTANDING THESE LIMITATIONS ON BIDDING, THE BIDDER WHO IS AWARDED ANY FEDERAL - AID FUNDED PROJECT SHALL COMPLY WITH CHAPTER 87 OF THE GENERAL STATUTES OF NORTH CAROLINA FOR LICENSING REQUIREMENTS WITHIN 60 CALENDAR DAYS OF BID OPENING.

**BIDS WILL BE RECEIVED AS SHOWN BELOW:**

**THIS IS A SIGNAL PROPOSAL**

**5% BID BOND OR BID DEPOSIT REQUIRED**

---

**PROPOSAL FOR THE CONSTRUCTION OF  
CONTRACT No. C203954 IN CUMBERLAND COUNTY, NORTH CAROLINA**

Date \_\_\_\_\_ 20 \_\_\_\_\_

**DEPARTMENT OF TRANSPORTATION,  
RALEIGH, NORTH CAROLINA**

The Bidder has carefully examined the location of the proposed work to be known as Contract No. C203954; has carefully examined the plans and specifications, which are acknowledged to be part of the proposal, the special provisions, the proposal, the form of contract, and the forms of contract payment bond and contract performance bond; and thoroughly understands the stipulations, requirements and provisions. The undersigned bidder agrees to be bound upon his execution of the bid and subsequent award to him by the Board of Transportation in accordance with this proposal to provide the necessary contract payment bond and contract performance bond within fourteen days after the written notice of award is received by him. The undersigned Bidder further agrees to provide all necessary machinery, tools, labor, and other means of construction; and to do all the work and to furnish all materials, except as otherwise noted, necessary to perform and complete the said contract in accordance with *the 2012 Standard Specifications for Roads and Structures* by the dates(s) specified in the Project Special Provisions and in accordance with the requirements of the Engineer, and at the unit or lump sum prices, as the case may be, for the various items given on the sheets contained herein.

The Bidder shall provide and furnish all the materials, machinery, implements, appliances and tools, and perform the work and required labor to construct and complete State Highway Contract No. C203954 in Cumberland County, for the unit or lump sum prices, as the case may be, bid by the Bidder in his bid and according to the proposal, plans, and specifications prepared by said Department, which proposal, plans, and specifications show the details covering this project, and hereby become a part of this contract.

The published volume entitled *North Carolina Department of Transportation, Raleigh, Standard Specifications for Roads and Structures, January 2012* with all amendments and supplements thereto, is by reference incorporated into and made a part of this contract; that, except as herein modified, all the construction and work included in this contract is to be done in accordance with the specifications contained in said volume, and amendments and supplements thereto, under the direction of the Engineer.

If the proposal is accepted and the award is made, the contract is valid only when signed either by the Contract Officer or such other person as may be designated by the Secretary to sign for the Department of Transportation. The conditions and provisions herein cannot be changed except over the signature of the said Contract Officer.

The quantities shown in the itemized proposal for the project are considered to be approximate only and are given as the basis for comparison of bids. The Department of Transportation may increase or decrease the quantity of any item or portion of the work as may be deemed necessary or expedient.

An increase or decrease in the quantity of an item will not be regarded as sufficient ground for an increase or decrease in the unit prices, nor in the time allowed for the completion of the work, except as provided for the contract.

Accompanying this bid is a bid bond secured by a corporate surety, or certified check payable to the order of the Department of Transportation, for five percent of the total bid price, which deposit is to be forfeited as liquidated damages in case this bid is accepted and the Bidder shall fail to provide the required payment and performance bonds with the Department of Transportation, under the condition of this proposal, within 14 calendar days after the written notice of award is received by him, as provided in the *Standard Specifications*; otherwise said deposit will be returned to the Bidder.

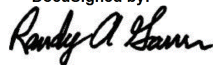

*State Contract Officer*

DocuSigned by:  
  
A7079FC32A09478... 1/13/2017

**TABLE OF CONTENTS**

**COVER SHEET  
PROPOSAL SHEET**

**PROJECT SPECIAL PROVISIONS**

CONTRACT TIME AND LIQUIDATED DAMAGES: ..... G-1  
INTERMEDIATE CONTRACT TIME NUMBER 1 AND LIQUIDATED DAMAGES: ..... G-1  
MAJOR CONTRACT ITEMS: ..... G-3  
NO SPECIALTY ITEMS: ..... G-3  
SCHEDULE OF ESTIMATED COMPLETION PROGRESS:..... G-3  
MINORITY BUSINESS ENTERPRISE AND WOMEN BUSINESS ENTERPRISE: ..... G-4  
CONTRACTOR'S LICENSE REQUIREMENTS: ..... G-19  
LOCATING EXISTING UNDERGROUND UTILITIES: ..... G-19  
VALUE ENGINEERING PROPOSAL: ..... G-19  
RESOURCE CONSERVATION AND ENV. SUSTAINABLE PRACTICES:..... G-20  
DOMESTIC STEEL: ..... G-21  
OUTSOURCING OUTSIDE THE USA: ..... G-21  
IRAN DIVESTMENT ACT: ..... G-21  
GIFTS FROM VENDORS AND CONTRACTORS: ..... G-22  
LIABILITY INSURANCE: ..... G-23  
EMPLOYMENT:..... G-23  
STATE HIGHWAY ADMINISTRATOR TITLE CHANGE:..... G-23  
SUBLETTING OF CONTRACT: ..... G-23

ROADWAY..... R-1

**STANDARD SPECIAL PROVISIONS**

AVAILABILITY FUNDS – TERMINATION OF CONTRACTS ..... SSP-1  
ERRATA..... SSP-2  
PLANT AND PEST QUARANTINES ..... SSP-4  
MINIMUM WAGES ..... SSP-5  
AWARD OF CONTRACT..... SSP-6  
ON-THE-JOB TRAINING..... SSP-11  
NCDENR NAME CHANGE..... SSP-14

**UNIT PROJECT SPECIAL PROVISIONS**

TRAFFIC SIGNALS ..... ITS-1

**PROPOSAL ITEM SHEET**

ITEM SHEET(S) (TAN SHEETS)

**PROJECT SPECIAL PROVISIONS****GENERAL****CONTRACT TIME AND LIQUIDATED DAMAGES:**

(7-1-95) (Rev. 12-18-07)

108

SPI G10 B

The date of availability for this contract is **April 3, 2017**.

The completion date for this contract is **October 15, 2019**.

The liquidated damages for this contract are **One Thousand Five Hundred Dollars (\$ 1,500.00)** per calendar day.

**INTERMEDIATE CONTRACT TIME NUMBER 1 AND LIQUIDATED DAMAGES:**

(2-20-07)

108

SPI G14 A

The Contractor shall complete the required work of installing, maintaining, and removing the traffic control devices for lane closures and restoring traffic to the existing traffic pattern. The Contractor shall not close or narrow travel lanes on **NC 24 (Grove Street), Bragg Boulevard, or NC 210 (Murchison Road)** during the following time restrictions:

**DAY AND TIME RESTRICTIONS**

**Monday thru Friday  
6:00 A.M. to 9:00 P.M.**

The Contractor shall complete the required work of installing, maintaining, and removing the traffic control devices for lane closures and restoring traffic to the existing traffic pattern. The Contractor shall not close or narrow travel lanes on **Rowan Street** during the following time restrictions:

**DAY AND TIME RESTRICTIONS**

**Monday thru Friday  
6:00 A.M. to 9:00 A.M. and  
4:00 P.M. to 7:00 P.M.**

In addition, the Contractor shall not close or narrow a lane of traffic on **NC 24 (Grove Street), Bragg Boulevard, NC 210 (Murchison Road), and Rowan Street** detain and/or alter the traffic flow on or during holidays, holiday weekends, special events, or any other time when traffic is unusually heavy, including the following schedules:

**HOLIDAY AND HOLIDAY WEEKEND LANE CLOSURE RESTRICTIONS**

1. For **unexpected occurrence** that creates unusually high traffic volumes, as directed by the Engineer.

2. For **New Year's Day**, between the hours of **6:00 A.M.** December 31<sup>st</sup> and **9:00 P.M.** January 2<sup>nd</sup>. If New Year's Day is on a Friday, Saturday, Sunday or Monday, then until **9:00 P.M.** the following Tuesday.
3. For **Easter**, between the hours of **6:00 A.M.** Thursday and **9:00 P.M.** Monday.
4. For **Memorial Day**, between the hours of **6:00 A.M.** Friday and **9:00 P.M.** Tuesday.
5. For **Independence Day**, between the hours of **6:00 A.M.** the day before Independence Day and **9:00 P.M.** the day after Independence Day.  
  
If **Independence Day** is on a Friday, Saturday, Sunday or Monday, then between the hours of **6:00 A.M.** the Thursday before Independence Day and **9:00 P.M.** the Tuesday after Independence Day.
6. For **Labor Day**, between the hours of **6:00 A.M.** Friday and **9:00 P.M.** Tuesday.
7. For **Thanksgiving Day**, between the hours of **6:00 A.M.** Tuesday and **9:00 P.M.** Monday.
8. For **Christmas**, between the hours of **6:00 A.M.** the Friday before the week of Christmas Day and **9:00 P.M.** the following Tuesday after the week of Christmas Day.
9. For the **Dogwood Festival**, between the hours of **6:00 A.M.** the **Friday** of the Dogwood Festival and **9:00 P.M.** the following Monday following the Dogwood Festival.
10. For the **International Folk Festival**, between the hours of **6:00 A.M.** the **Friday** of the **International Folk Festival** and **9:00 P.M.** the following Monday following the **International Folk Festival**.
11. For events at the following venues between two (2) hours before and the start and two (2) hours after the end:
  - Fayetteville State University
    1. Football games
    2. Men's basketball games
    3. Women's basketball games
    4. Graduation
  - Airborne & Special Operations Museum
  - Other events as noted by the Engineer

Holidays and holiday weekends shall include New Year's, Easter, Memorial Day, Independence Day, Labor Day, Thanksgiving, and Christmas. The Contractor shall schedule his work so that lane closures will not be required during these periods, unless otherwise directed by the Engineer.

The time of availability for this intermediate contract work shall be the time the Contractor begins to install all traffic control devices for lane closures according to the time restrictions listed herein.

The completion time for this intermediate contract work shall be the time the Contractor is required to complete the removal of all traffic control devices for lane closures according to the time restrictions stated above and place traffic in the existing traffic pattern.

The liquidated damages are **One Thousand Dollars (\$ 1,000.00)** per fifteen (15) minute time period.

**MAJOR CONTRACT ITEMS:**

(2-19-02) 104 SP1 G28

The following listed items are the major contract items for this contract (see Article 104-5 of the *2012 Standard Specifications*):

<b>Line #</b>	<b>Description</b>
44 —	Controller With Cabinet (2070E, 332 Base Mounted)
53 —	Controller With Cabinet And Aux File (2070E, 332 Base Mounted)

**NO SPECIALTY ITEMS:**

(7-1-95) 108-6 SP1 G34

None of the items included in this contract will be specialty items (see Article 108-6 of the *2012 Standard Specifications*).

**SCHEDULE OF ESTIMATED COMPLETION PROGRESS:**

(7-15-08) (Rev. 5-17-16) 108-2 SP1 G58

The Contractor's attention is directed to the Standard Special Provision entitled *Availability of Funds Termination of Contracts* included elsewhere in this proposal. The Department of Transportation's schedule of estimated completion progress for this project as required by that Standard Special Provision is as follows:

	<b><u>Fiscal Year</u></b>	<b><u>Progress (% of Dollar Value)</u></b>
2017	(7/01/16 - 6/30/17)	<b>15%</b> of Total Amount Bid
2018	(7/01/17 - 6/30/18)	<b>48%</b> of Total Amount Bid
2019	(7/01/18 - 6/30/19)	<b>32%</b> of Total Amount Bid
2020	(7/01/19 - 6/30/20)	<b>5%</b> of Total Amount Bid

The Contractor shall also furnish his own progress schedule in accordance with Article 108-2 of the *2012 Standard Specifications*. Any acceleration of the progress as shown by the Contractor's progress schedule over the progress as shown above shall be subject to the approval of the Engineer.

**MINORITY BUSINESS ENTERPRISE AND WOMEN BUSINESS ENTERPRISE:**

(10-16-07)(Rev. 1-17-17)

102-15(J)

SP1 G66

**Description**

The purpose of this Special Provision is to carry out the North Carolina Department of Transportation's policy of ensuring nondiscrimination in the award and administration of contracts financed in whole or in part with State funds.

**Definitions**

*Additional MBE/WBE Subcontractors* - Any MBE/WBE submitted at the time of bid that will not be used to meet either the MBE or WBE goal. No submittal of a Letter of Intent is required, unless the additional participation is used for banking purposes.

*Committed MBE/WBE Subcontractor* - Any MBE/WBE submitted at the time of bid that is being used to meet either the MBE or WBE goal by submission of a Letter of Intent. Or any MBE or WBE used as a replacement for a previously committed MBE or WBE firm.

*Contract Goals Requirement* - The approved MBE and WBE participation at time of award, but not greater than the advertised contract goals for each.

*Goal Confirmation Letter* - Written documentation from the Department to the bidder confirming the Contractor's approved, committed MBE and WBE participation along with a listing of the committed MBE and WBE firms.

*Manufacturer* - A firm that operates or maintains a factory or establishment that produces on the premises, the materials or supplies obtained by the Contractor.

*MBE Goal* - A portion of the total contract, expressed as a percentage, that is to be performed by committed MBE subcontractor(s).

*Minority Business Enterprise (MBE)* - A firm certified as a Disadvantaged Minority-Owned Business Enterprise through the North Carolina Unified Certification Program.

*Regular Dealer* - A firm that owns, operates, or maintains a store, warehouse, or other establishment in which the materials or supplies required for the performance of the contract are bought, kept in stock, and regularly sold to the public in the usual course of business. A regular dealer engages in, as its principal business and in its own name, the purchase and sale or lease of the products in question. A regular dealer in such bulk items as steel, cement, gravel, stone, and petroleum products need not keep such products in stock, if it owns and operates distribution equipment for the products. Brokers and packagers are not regarded as manufacturers or regular dealers within the meaning of this section.

*North Carolina Unified Certification Program (NCUCP)* - A program that provides comprehensive services and information to applicants for MBE/WBE certification.



The MBE/WBE program follows the same regulations as the federal Disadvantaged Business Enterprise (DBE) program in accordance with 49 CFR Part 26.

*United States Department of Transportation (USDOT)* - Federal agency responsible for issuing regulations (49 CFR Part 26) and official guidance for the DBE program.

*WBE Goal* - A portion of the total contract, expressed as a percentage, that is to be performed by committed WBE subcontractor(s).

*Women Business Enterprise (WBE)* - A firm certified as a Disadvantaged Women-Owned Business Enterprise through the North Carolina Unified Certification Program.

### **Forms and Websites Referenced in this Provision**

*Payment Tracking System* - On-line system in which the Contractor enters the payments made to MBE and WBE subcontractors who have performed work on the project.  
<https://apps.dot.state.nc.us/Vendor/PaymentTracking/>

*DBE-IS Subcontractor Payment Information* - Form for reporting the payments made to all MBE/WBE firms working on the project. This form is for paper bid projects only.  
<https://connect.ncdot.gov/business/Turnpike/Documents/Form%20DBE-IS%20Subcontractor%20Payment%20Information.pdf>

*RF-1 MBE/WBE Replacement Request Form* - Form for replacing a committed MBE or WBE.  
<http://connect.ncdot.gov/projects/construction/Construction%20Forms/DBE%20MBE%20WBE%20Replacement%20Request%20Form.pdf>

*SAF Subcontract Approval Form* - Form required for approval to sublet the contract.  
<http://connect.ncdot.gov/projects/construction/Construction%20Forms/Subcontract%20Approval%20Form%20Rev.%202012.zip>

*JC-1 Joint Check Notification Form* - Form and procedures for joint check notification. The form acts as a written joint check agreement among the parties providing full and prompt disclosure of the expected use of joint checks.  
<http://connect.ncdot.gov/projects/construction/Construction%20Forms/Joint%20Check%20Notification%20Form.pdf>

*Letter of Intent* - Form signed by the Contractor and the MBE/WBE subcontractor, manufacturer or regular dealer that affirms that a portion of said contract is going to be performed by the signed MBE/WBE for the amount listed at the time of bid.  
<http://connect.ncdot.gov/letting/LetCentral/Letter%20of%20Intent%20to%20Perform%20as%20a%20Subcontractor.pdf>

*Listing of MBE and WBE Subcontractors Form* - Form for entering MBE/WBE subcontractors on a project that will meet this MBE and WBE goals. This form is for paper bids only.  
[http://connect.ncdot.gov/municipalities/Bid%20Proposals%20for%20LGA%20Content/09%20MBE-WBE%20Subcontractors%20\(State\).docx](http://connect.ncdot.gov/municipalities/Bid%20Proposals%20for%20LGA%20Content/09%20MBE-WBE%20Subcontractors%20(State).docx)

*Subcontractor Quote Comparison Sheet* - Spreadsheet for showing all subcontractor quotes in the work areas where MBEs and WBEs quoted on the project. This sheet is submitted with good faith effort packages.

<http://connect.ncdot.gov/business/SmallBusiness/Documents/DBE%20Subcontractor%20Quote%20Comparison%20Example.xls>

### **MBE and WBE Goal**

The following goals for participation by Minority Business Enterprises and Women Business Enterprises are established for this contract:

(A) Minority Business Enterprises **0.0 %**

- (1) *If the MBE goal is more than zero*, the Contractor shall exercise all necessary and reasonable steps to ensure that MBEs participate in at least the percent of the contract as set forth above as the MBE goal.
- (2) *If the MBE goal is zero*, the Contractor shall make an effort to recruit and use MBEs during the performance of the contract. Any MBE participation obtained shall be reported to the Department.

(B) Women Business Enterprises **0.0 %**

- (1) *If the WBE goal is more than zero*, the Contractor shall exercise all necessary and reasonable steps to ensure that WBEs participate in at least the percent of the contract as set forth above as the WBE goal.
- (2) *If the WBE goal is zero*, the Contractor shall make an effort to recruit and use WBEs during the performance of the contract. Any WBE participation obtained shall be reported to the Department.

### **Directory of Transportation Firms (Directory)**

Real-time information is available about firms doing business with the Department and firms that are certified through NCUCP in the Directory of Transportation Firms. Only firms identified in the Directory as MBE and WBE certified shall be used to meet the MBE and WBE goals respectively. The Directory can be found at the following link. <https://partner.ncdot.gov/VendorDirectory/default.html>

The listing of an individual firm in the directory shall not be construed as an endorsement of the firm's capability to perform certain work.

### **Listing of MBE/WBE Subcontractors**

At the time of bid, bidders shall submit all MBE and WBE participation that they anticipate to use during the life of the contract. Only those identified to meet the MBE goal and the

WBE goal will be considered committed, even though the listing shall include both committed MBE/WBE subcontractors and additional MBE/WBE subcontractors. Any additional MBE/WBE subcontractor participation above the goal for which letters of intent are received will follow the banking guidelines found elsewhere in this provision. All other additional MBE/WBE subcontractor participation submitted at the time of bid will be used toward the Department's overall race-neutral goals. Only those firms with current MBE and WBE certification at the time of bid opening will be acceptable for listing in the bidder's submittal of MBE and WBE participation. The Contractor shall indicate the following required information:

(A) Electronic Bids

Bidders shall submit a listing of MBE and WBE participation in the appropriate section of Expedite, the bidding software of Bid Express<sup>®</sup>.

- (1) Submit the names and addresses of MBE and WBE firms identified to participate in the contract. If the bidder uses the updated listing of MBE and WBE firms shown in Expedite, the bidder may use the dropdown menu to access the name and address of the firms.
- (2) Submit the contract line numbers of work to be performed by each MBE and WBE firm. When no figures or firms are entered, the bidder will be considered to have no MBE or WBE participation.
- (3) The bidder shall be responsible for ensuring that the MBE and WBE are certified at the time of bid by checking the Directory of Transportation Firms. If the firm is not certified at the time of the bid-letting, that MBE's or WBE's participation will not count towards achieving either the MBE or WBE goal.

(B) Paper Bids

- (1) *If either the MBE or WBE goal is more than zero,*
  - (a) Bidders, at the time the bid proposal is submitted, shall submit a listing of MBE/WBE participation, including the names and addresses on *Listing of MBE and WBE Subcontractors* contained elsewhere in the contract documents in order for the bid to be considered responsive. Bidders shall indicate the total dollar value of the MBE and WBE participation for the contract.
  - (b) If bidders have no MBE or WBE participation, they shall indicate this on the *Listing of MBE and WBE Subcontractors* by entering the word "None" or the number "0." This form shall be completed in its entirety. **Blank forms will not be deemed to represent zero participation.** Bids submitted that do not have MBE and WBE participation indicated on the appropriate form will not be read publicly during the opening of bids. The

Department will not consider these bids for award and the proposal will be rejected.

- (c) The bidder shall be responsible for ensuring that the MBE/WBE is certified at the time of bid by checking the Directory of Transportation Firms. If the firm is not certified at the time of the bid-letting, that MBE's or WBE's participation will not count towards achieving the corresponding goal.
- (2) *If either the MBE or WBE goal is zero, entries on the Listing of MBE and WBE Subcontractors are not required for the zero goal, however any MBE or WBE participation that is achieved during the project shall be reported in accordance with requirements contained elsewhere in the special provision.*

### **MBE or WBE Prime Contractor**

When a certified MBE or WBE firm bids on a contract that contains MBE and WBE goals, the firm is responsible for meeting the goals or making good faith efforts to meet the goals, just like any other bidder. In most cases, a MBE or WBE bidder on a contract will meet one of the goals by virtue of the work it performs on the contract with its own forces. However, all the work that is performed by the MBE or WBE bidder and any other similarly certified subcontractors will count toward the goal. The MBE or WBE bidder shall list itself along with any MBE or WBE subcontractors, if any, in order to receive credit toward the goals.

For example, on a proposed contract, the WBE goal is 10%, and the MBE goal is 8%. A WBE bidder puts in a bid where they will perform 40% of the contract work and have a WBE subcontractor which will perform another 5% of the work. Together the two WBE firms submit on the *Listing of MBE and WBE Subcontractors* a value of 45% of the contract which fulfills the WBE goal. The 8% MBE goal shall be obtained through MBE participation with MBE certified subcontractors or documented through a good faith effort. It should be noted that you cannot combine the two goals to meet an overall value. The two goals shall remain separate.

MBE/WBE prime contractors shall also follow Sections A and B listed under *Listing of MBE and WBE Subcontractor* just as a non-MBE/WBE bidder would.

### **Written Documentation – Letter of Intent**

The bidder shall submit written documentation for each MBE/WBE that will be used to meet the MBE and WBE goals of the contract, indicating the bidder's commitment to use the MBE/WBE in the contract. This documentation shall be submitted on the Department's form titled *Letter of Intent*.

The documentation shall be received in the office of the State Contractor Utilization Engineer or at DBE@ncdot.gov no later than 10:00 a.m. of the sixth calendar day following opening of bids, unless the sixth day falls on an official state holiday. In that situation, it is due in the office of

the State Contractor Utilization Engineer no later than 10:00 a.m. on the next official state business day.

If the bidder fails to submit the Letter of Intent from each committed MBE and WBE to be used toward the MBE and WBE goals, or if the form is incomplete (i.e. both signatures are not present), the MBE/WBE participation will not count toward meeting the MBE/WBE goal. If the lack of this participation drops the commitment below either the MBE or WBE goal, the Contractor shall submit evidence of good faith efforts for the goal not met, completed in its entirety, to the State Contractor Utilization Engineer or DBE@ncdot.gov no later than 10:00 a.m. on the eighth calendar day following opening of bids, unless the eighth day falls on an official state holiday. In that situation, it is due in the office of the State Contractor Utilization Engineer no later than 10:00 a.m. on the next official state business day.

### **Banking MBE/WBE Credit**

If the bid of the lowest responsive bidder exceeds \$500,000 and if the committed MBE/WBE participation submitted by Letter of Intent exceeds the algebraic sum of the MBE or WBE goal by \$1,000 or more, the excess will be placed on deposit by the Department for future use by the bidder. Separate accounts will be maintained for MBE and WBE participation and these may accumulate for a period not to exceed 24 months.

When the apparent lowest responsive bidder fails to submit sufficient participation by MBE firms to meet the contract goal, as part of the good faith effort, the Department will consider allowing the bidder to withdraw funds to meet the MBE goal as long as there are adequate funds available from the bidder's MBE bank account.

When the apparent lowest responsive bidder fails to submit sufficient participation by WBE firms to meet the contract goal, as part of the good faith effort, the Department will consider allowing the bidder to withdraw funds to meet the WBE goal as long as there are adequate funds available from the bidder's WBE bank account.

### **Submission of Good Faith Effort**

If the bidder fails to meet or exceed either the MBE or the WBE goal, the apparent lowest responsive bidder shall submit to the Department documentation of adequate good faith efforts made to reach that specific goal(s).

A hard copy and an electronic copy of this information shall be received in the office of the State Contractor Utilization Engineer or at DBE@ncdot.gov no later than 10:00 a.m. on the sixth calendar day following opening of bids unless the sixth day falls on an official state holiday. In that situation, it would be due in the office of the State Contractor Utilization Engineer no later than 10:00 a.m. on the next official state business day. If the contractor cannot send the information electronically, then one complete set and 9 copies of this information shall be received under the same time constraints above.

Note: Where the information submitted includes repetitious solicitation letters, it will be acceptable to submit a representative letter along with a distribution list of the firms that were solicited. Documentation of MBE/WBE quotations shall be a part of the good faith effort submittal. This documentation may include written subcontractor quotations, telephone log notations of verbal quotations, or other types of quotation documentation.

### **Consideration of Good Faith Effort for Projects with MBE/WBE Goals More Than Zero**

Adequate good faith efforts mean that the bidder took all necessary and reasonable steps to achieve the goal which, by their scope, intensity, and appropriateness, could reasonably be expected to obtain sufficient MBE/WBE participation. Adequate good faith efforts also mean that the bidder actively and aggressively sought MBE/WBE participation. Mere *pro forma* efforts are not considered good faith efforts.

The Department will consider the quality, quantity, and intensity of the different kinds of efforts a bidder has made. Listed below are examples of the types of actions a bidder will take in making a good faith effort to meet the goals and are not intended to be exclusive or exhaustive, nor is it intended to be a mandatory checklist.

- (A) Soliciting through all reasonable and available means (e.g. attendance at pre-bid meetings, advertising, written notices, use of verifiable electronic means through the use of the NCDOT Directory of Transportation Firms) the interest of all certified MBEs/WBEs that are also prequalified subcontractors. The bidder must solicit this interest within at least 10 days prior to bid opening to allow the MBEs/WBEs to respond to the solicitation. Solicitation shall provide the opportunity to MBEs/WBEs within the Division and surrounding Divisions where the project is located. The bidder must determine with certainty if the MBEs/WBEs are interested by taking appropriate steps to follow up initial solicitations.
- (B) Selecting portions of the work to be performed by MBEs/WBEs in order to increase the likelihood that the MBE and WBE goals will be achieved.
  - (1) Where appropriate, break out contract work items into economically feasible units to facilitate MBE/WBE participation, even when the prime contractor might otherwise prefer to perform these work items with its own forces.
  - (2) Negotiate with subcontractors to assume part of the responsibility to meet the contract MBE/WBE goals when the work to be sublet includes potential for MBE/WBE participation (2<sup>nd</sup> and 3<sup>rd</sup> tier subcontractors).
- (C) Providing interested certified MBEs/WBEs that are also prequalified subcontractors with adequate information about the plans, specifications, and requirements of the contract in a timely manner to assist them in responding to a solicitation.
- (D) (1) Negotiating in good faith with interested MBEs/WBEs. It is the bidder's

responsibility to make a portion of the work available to MBE/WBE subcontractors and suppliers and to select those portions of the work or material needs consistent with the available MBE/WBE subcontractors and suppliers, so as to facilitate MBE/WBE participation. Evidence of such negotiation includes the names, addresses, and telephone numbers of MBEs/WBEs that were considered; a description of the information provided regarding the plans and specifications for the work selected for subcontracting; and evidence as to why additional agreements could not be reached for MBEs/WBEs to perform the work.

- (2) A bidder using good business judgment would consider a number of factors in negotiating with subcontractors, including MBE/WBE subcontractors, and would take a firm's price and capabilities as well as contract goals into consideration. However, the fact that there may be some additional costs involved in finding and using MBEs/WBEs is not in itself sufficient reason for a bidder's failure to meet the contract MBE or WBE goals, as long as such costs are reasonable. Also, the ability or desire of a prime contractor to perform the work of a contract with its own organization does not relieve the bidder of the responsibility to make good faith efforts. Bidding contractors are not, however, required to accept higher quotes from MBEs/WBEs if the price difference is excessive or unreasonable.
- (E) Not rejecting MBEs/WBEs as being unqualified without sound reasons based on a thorough investigation of their capabilities. The bidder's standing within its industry, membership in specific groups, organizations, or associates and political or social affiliations (for example, union vs. non-union employee status) are not legitimate causes for the rejection or non-solicitation of bids in the bidder's efforts to meet the project goal.
- (F) Making efforts to assist interested MBEs/WBEs in obtaining bonding, lines of credit, or insurance as required by the recipient or bidder.
- (G) Making efforts to assist interested MBEs/WBEs in obtaining necessary equipment, supplies, materials, or related assistance or services.
- (H) Effectively using the services of available minority/women community organizations; minority/women contractors' groups; Federal, State, and local minority/women business assistance offices; and other organizations as allowed on a case-by-case basis to provide assistance in the recruitment and placement of MBEs/WBEs. Contact within 7 days from the bid opening the Business Opportunity and Work Force Development Unit at [DBE@ncdot.gov](mailto:DBE@ncdot.gov) to give notification of the bidder's inability to get MBE or WBE quotes.
- (I) Any other evidence that the bidder submits which shows that the bidder has made reasonable good faith efforts to meet the MBE and WBE goal.

In addition, the Department may take into account the following:

- (1) Whether the bidder's documentation reflects a clear and realistic plan for achieving the MBE and WBE goals.
- (2) The bidders' past performance in meeting the MBE and WBE goals.
- (3) The performance of other bidders in meeting the MBE and WBE goals. For example, when the apparent successful bidder fails to meet the goals, but others meet it, you may reasonably raise the question of whether, with additional reasonable efforts the apparent successful bidder could have met the goals. If the apparent successful bidder fails to meet the MBE and WBE goals, but meets or exceeds the average MBE and WBE participation obtained by other bidders, the Department may view this, in conjunction with other factors, as evidence of the apparent successful bidder having made a good faith effort.

If the Department does not award the contract to the apparent lowest responsive bidder, the Department reserves the right to award the contract to the next lowest responsive bidder that can satisfy to the Department that the MBE and WBE goals can be met or that an adequate good faith effort has been made to meet the MBE and WBE goals.

### **Non-Good Faith Appeal**

The State Contractual Services Engineer will notify the contractor verbally and in writing of non-good faith. A contractor may appeal a determination of non-good faith made by the Goal Compliance Committee. If a contractor wishes to appeal the determination made by the Committee, they shall provide written notification to the State Contractual Services Engineer or at DBE@ncdot.gov. The appeal shall be made within 2 business days of notification of the determination of non-good faith.

### **Counting MBE/WBE Participation Toward Meeting MBE/WBE Goals**

#### **(A) Participation**

The total dollar value of the participation by a committed MBE/WBE will be counted toward the contract goal requirements. The total dollar value of participation by a committed MBE/WBE will be based upon the value of work actually performed by the MBE/WBE and the actual payments to MBE/WBE firms by the Contractor.

#### **(B) Joint Checks**

Prior notification of joint check use shall be required when counting MBE/WBE participation for services or purchases that involves the use of a joint check. Notification shall be through submission of Form JC-1 (*Joint Check Notification Form*) and the use of joint checks shall be in accordance with the Department's Joint Check Procedures.



## (C) Subcontracts (Non-Trucking)

A MBE/WBE may enter into subcontracts. Work that a MBE subcontracts to another MBE firm may be counted toward the MBE contract goal requirement. The same holds for work that a WBE subcontracts to another WBE firm. Work that a MBE subcontracts to a non-MBE firm does not count toward the MBE contract goal requirement. Again, the same holds true for the work that a WBE subcontracts to a non-WBE firm. If a MBE or WBE contractor or subcontractor subcontracts a significantly greater portion of the work of the contract than would be expected on the basis of standard industry practices, it shall be presumed that the MBE or WBE is not performing a commercially useful function. The MBE/WBE may present evidence to rebut this presumption to the Department. The Department's decision on the rebuttal of this presumption may be subject to review by the Office of Inspector General, NCDOT.

## (D) Joint Venture

When a MBE or WBE performs as a participant in a joint venture, the Contractor may count toward its contract goal requirement a portion of the total value of participation with the MBE or WBE in the joint venture, that portion of the total dollar value being a distinct clearly defined portion of work that the MBE or WBE performs with its forces.

## (E) Suppliers

A contractor may count toward its MBE or WBE requirement 60 percent of its expenditures for materials and supplies required to complete the contract and obtained from a MBE or WBE regular dealer and 100 percent of such expenditures from a MBE or WBE manufacturer.

## (F) Manufacturers and Regular Dealers

A contractor may count toward its MBE or WBE requirement the following expenditures to MBE/WBE firms that are not manufacturers or regular dealers:

- (1) The fees or commissions charged by a MBE/WBE firm for providing a *bona fide* service, such as professional, technical, consultant, or managerial services, or for providing bonds or insurance specifically required for the performance of a DOT-assisted contract, provided the fees or commissions are determined to be reasonable and not excessive as compared with fees and commissions customarily allowed for similar services.
- (2) With respect to materials or supplies purchased from a MBE/WBE, which is neither a manufacturer nor a regular dealer, count the entire amount of fees or commissions charged for assistance in the procurement of the materials and supplies, or fees or transportation charges for the delivery of materials or supplies required on a job site (but not the cost of the materials and supplies themselves),

provided the fees are determined to be reasonable and not excessive as compared with fees customarily allowed for similar services.

### **Commercially Useful Function**

(A) MBE/WBE Utilization

The Contractor may count toward its contract goal requirement only expenditures to MBEs and WBEs that perform a commercially useful function in the work of a contract. A MBE/WBE performs a commercially useful function when it is responsible for execution of the work of the contract and is carrying out its responsibilities by actually performing, managing, and supervising the work involved. To perform a commercially useful function, the MBE/WBE shall also be responsible with respect to materials and supplies used on the contract, for negotiating price, determining quality and quantity, ordering the material and installing (where applicable) and paying for the material itself. To determine whether a MBE/WBE is performing a commercially useful function, the Department will evaluate the amount of work subcontracted, industry practices, whether the amount the firm is to be paid under the contract is commensurate with the work it is actually performing and the MBE/WBE credit claimed for its performance of the work, and any other relevant factors.

(B) MBE/WBE Utilization in Trucking

The following factors will be used to determine if a MBE or WBE trucking firm is performing a commercially useful function:

- (1) The MBE/WBE shall be responsible for the management and supervision of the entire trucking operation for which it is responsible on a particular contract, and there shall not be a contrived arrangement for the purpose of meeting the MBE or WBE goal.
- (2) The MBE/WBE shall itself own and operate at least one fully licensed, insured, and operational truck used on the contract.
- (3) The MBE/WBE receives credit for the total value of the transportation services it provides on the contract using trucks it owns, insures, and operates using drivers it employs.
- (4) The MBE may subcontract the work to another MBE firm, including an owner-operator who is certified as a MBE. The same holds true that a WBE may subcontract the work to another WBE firm, including an owner-operator who is certified as a WBE. When this occurs, the MBE or WBE who subcontracts work receives credit for the total value of the transportation services the subcontracted MBE or WBE provides on the contract. It should be noted that every effort shall be made by MBE and WBE contractors to subcontract to the same certification (i.e., MBEs to MBEs and WBEs to WBEs), in order to fulfill

the goal requirement. This, however, may not always be possible due to the limitation of firms in the area. If the MBE or WBE firm shows a good faith effort has been made to reach out to similarly certified transportation service providers and there is no interest or availability, and they can get assistance from other certified providers, the Engineer will not hold the prime liable for meeting the goal.

- (5) The MBE/WBE may also subcontract the work to a non-MBE/WBE firm, including from an owner-operator. The MBE/WBE who subcontracts the work to a non-MBE/WBE is entitled to credit for the total value of transportation services provided by the non-MBE/WBE subcontractor not to exceed the value of transportation services provided by MBE/WBE-owned trucks on the contract. Additional participation by non-MBE/WBE subcontractors receives credit only for the fee or commission it receives as a result of the subcontract arrangement. The value of services performed under subcontract agreements between the MBE/WBE and the Contractor will not count towards the MBE/WBE contract requirement.
- (6) A MBE/WBE may lease truck(s) from an established equipment leasing business open to the general public. The lease must indicate that the MBE/WBE has exclusive use of and control over the truck. This requirement does not preclude the leased truck from working for others during the term of the lease with the consent of the MBE/WBE, so long as the lease gives the MBE/WBE absolute priority for use of the leased truck. This type of lease may count toward the MBE/WBE's credit as long as the driver is under the MBE/WBE's payroll.
- (7) Subcontracted/leased trucks shall display clearly on the dashboard the name of the MBE/WBE that they are subcontracted/leased to and their own company name if it is not identified on the truck itself. Magnetic door signs are not permitted.

### **MBE/WBE Replacement**

When a Contractor has relied on a commitment to a MBE or WBE firm (or an approved substitute MBE or WBE firm) to meet all or part of a contract goal requirement, the contractor shall not terminate the MBE/WBE for convenience. This includes, but is not limited to, instances in which the Contractor seeks to perform the work of the terminated subcontractor with another MBE/WBE subcontractor, a non-MBE/WBE subcontractor, or with the Contractor's own forces or those of an affiliate. A MBE/WBE may only be terminated after receiving the Engineer's written approval based upon a finding of good cause for the termination. The prime contractor must give the MBE/WBE firm five (5) calendar days to respond to the prime contractor's notice of termination and advise the prime contractor and the Department of the reasons, if any, why the firm objects to the proposed termination of its subcontract and why the Department should not approve the action.

All requests for replacement of a committed MBE/WBE firm shall be submitted to the Engineer for approval on Form RF-1 (*Replacement Request*). If the Contractor fails to follow this

procedure, the Contractor may be disqualified from further bidding for a period of up to 6 months.

The Contractor shall comply with the following for replacement of a committed MBE/WBE:

(A) Performance Related Replacement

When a committed MBE is terminated for good cause as stated above, an additional MBE that was submitted at the time of bid may be used to fulfill the MBE commitment. The same holds true if a committed WBE is terminated for good cause, an additional WBE that was submitted at the time of bid may be used to fulfill the WBE goal. A good faith effort will only be required for removing a committed MBE/WBE if there were no additional MBEs/WBEs submitted at the time of bid to cover the same amount of work as the MBE/WBE that was terminated.

If a replacement MBE/WBE is not found that can perform at least the same amount of work as the terminated MBE/WBE, the Contractor shall submit a good faith effort documenting the steps taken. Such documentation shall include, but not be limited to, the following:

- (1) Copies of written notification to MBEs/WBEs that their interest is solicited in contracting the work defaulted by the previous MBE/WBE or in subcontracting other items of work in the contract.
- (2) Efforts to negotiate with MBEs/WBEs for specific subbids including, at a minimum:
  - (a) The names, addresses, and telephone numbers of MBEs/WBEs who were contacted.
  - (b) A description of the information provided to MBEs/WBEs regarding the plans and specifications for portions of the work to be performed.
- (3) A list of reasons why MBE/WBE quotes were not accepted.
- (4) Efforts made to assist the MBEs/WBEs contacted, if needed, in obtaining bonding or insurance required by the Contractor.

(B) Decertification Replacement

- (1) When a committed MBE/WBE is decertified by the Department after the SAF (*Subcontract Approval Form*) has been received by the Department, the Department will not require the Contractor to solicit replacement MBE/WBE participation equal to the remaining work to be performed by the decertified firm. The participation equal to the remaining work performed by the decertified firm will count toward the contract goal requirement.

- (2) When a committed MBE/WBE is decertified prior to the Department receiving the SAF (*Subcontract Approval Form*) for the named MBE/WBE firm, the Contractor shall take all necessary and reasonable steps to replace the MBE/WBE subcontractor with another similarly certified MBE/WBE subcontractor to perform at least the same amount of work to meet the MBE/WBE goal requirement. If a MBE/WBE firm is not found to do the same amount of work, a good faith effort must be submitted to NCDOT (see A herein for required documentation).

### **Changes in the Work**

When the Engineer makes changes that result in the reduction or elimination of work to be performed by a committed MBE/WBE, the Contractor will not be required to seek additional participation. When the Engineer makes changes that result in additional work to be performed by a MBE/WBE based upon the Contractor's commitment, the MBE/WBE shall participate in additional work to the same extent as the MBE/WBE participated in the original contract work.

When the Engineer makes changes that result in extra work, which has more than a minimal impact on the contract amount, the Contractor shall seek additional participation by MBEs/WBEs unless otherwise approved by the Engineer.

When the Engineer makes changes that result in an alteration of plans or details of construction, and a portion or all of the work had been expected to be performed by a committed MBE/WBE, the Contractor shall seek participation by MBEs/WBEs unless otherwise approved by the Engineer.

When the Contractor requests changes in the work that result in the reduction or elimination of work that the Contractor committed to be performed by a MBE/WBE, the Contractor shall seek additional participation by MBEs/WBEs equal to the reduced MBE/WBE participation caused by the changes.

### **Reports and Documentation**

A SAF (*Subcontract Approval Form*) shall be submitted for all work which is to be performed by a MBE/WBE subcontractor. The Department reserves the right to require copies of actual subcontract agreements involving MBE/WBE subcontractors.

When using transportation services to meet the contract commitment, the Contractor shall submit a proposed trucking plan in addition to the SAF. The plan shall be submitted prior to beginning construction on the project. The plan shall include the names of all trucking firms proposed for use, their certification type(s), the number of trucks owned by the firm, as well as the individual truck identification numbers, and the line item(s) being performed.

Within 30 calendar days of entering into an agreement with a MBE/WBE for materials, supplies or services, not otherwise documented by the SAF as specified above, the Contractor shall

furnish the Engineer a copy of the agreement. The documentation shall also indicate the percentage (60% or 100%) of expenditures claimed for MBE/WBE credit.

### **Reporting Minority and Women Business Enterprise Participation**

The Contractor shall provide the Engineer with an accounting of payments made to all MBE and WBE firms, including material suppliers and contractors at all levels (prime, subcontractor, or second tier subcontractor). This accounting shall be furnished to the Engineer for any given month by the end of the following month. Failure to submit this information accordingly may result in the following action:

- (A) Withholding of money due in the next partial pay estimate; or
- (B) Removal of an approved contractor from the prequalified bidders' list or the removal of other entities from the approved subcontractors list.

While each contractor (prime, subcontractor, 2nd tier subcontractor) is responsible for accurate accounting of payments to MBEs/WBEs, it shall be the prime contractor's responsibility to report all monthly and final payment information in the correct reporting manner.

Failure on the part of the Contractor to submit the required information in the time frame specified may result in the disqualification of that contractor and any affiliate companies from further bidding until the required information is submitted.

Failure on the part of any subcontractor to submit the required information in the time frame specified may result in the disqualification of that contractor and any affiliate companies from being approved for work on future DOT projects until the required information is submitted.

Contractors reporting transportation services provided by non-MBE/WBE lessees shall evaluate the value of services provided during the month of the reporting period only.

At any time, the Engineer can request written verification of subcontractor payments.

The Contractor shall report the accounting of payments through the Department's Payment Tracking System.

### **Failure to Meet Contract Requirements**

Failure to meet contract requirements in accordance with Subarticle 102-15(J) of the *2012 Standard Specifications* may be cause to disqualify the Contractor.

**CONTRACTOR'S LICENSE REQUIREMENTS:**

(7-1-95)

102-14

SP1 G88

If the successful bidder does not hold the proper license to perform any plumbing, heating, air conditioning, or electrical work in this contract, he will be required to sublet such work to a contractor properly licensed in accordance with *Article 2 of Chapter 87 of the General Statutes* (licensing of heating, plumbing, and air conditioning contractors) and *Article 4 of Chapter 87 of the General Statutes* (licensing of electrical contractors).

**LOCATING EXISTING UNDERGROUND UTILITIES:**

(3-20-12)

105

SP1 G115

Revise the *2012 Standard Specifications* as follows:

**Page 1-43, Article 105-8, line 28, after the first sentence, add the following:**

Identify excavation locations by means of pre-marking with white paint, flags, or stakes or provide a specific written description of the location in the locate request.

**VALUE ENGINEERING PROPOSAL:**

(05-19-15)

104

SP01 G116

Revise the *2012 Standard Specifications* as follows:

**Page 1-36, Subarticle 104-12(B) Evaluation of Proposals, lines 42-44, replace the fourth sentence of the second paragraph with the following:**

Pending execution of a formal supplemental agreement implementing an approved VEP and transfer of final plans (hard copy and electronic) sealed by an engineer licensed in the State of North Carolina incorporating an approved VEP to the Resident Engineer and the State Value Management Engineer, the Contractor shall remain obligated to perform the work in accordance with the terms of the existing contract.

**Page 1-37, Subarticle 104-12(D) Preliminary Review, lines 9-12, replace the first sentence of the first paragraph with the following:**

Should the Contractor desire a preliminary review of a possible VEP, before expending considerable time and expense in full development, a copy of the Preliminary VEP shall be submitted to the Resident Engineer and the State Value Management Engineer at ValueManagementUnit@ncdot.gov.

**Page 1-37, Subarticle 104-12(E) Final Proposal, lines 22-23, replace the first sentence of the first paragraph with the following:**

A copy of the Final VEP shall be submitted by the Contractor to the Resident Engineer and the State Value Management Engineer at ValueManagementUnit@ncdot.gov.

**Page 1-38, Subarticle 104-12(F) Modifications, lines 2-8,** replace the first paragraph with the following:

To facilitate the preparation of revisions to contract drawings, the Contractor may purchase reproducible copies of drawings for his use through the Department's Value Management Unit. The preparation of new design drawings by or for the Contractor shall be coordinated with the appropriate Design Branch through the State Value Management Engineer. The Contractor shall provide, at no charge to the Department, one set of reproducible drawings of the approved design needed to implement the VEP. Drawings (hard copy and electronic) which are sealed by an engineer licensed in the State of North Carolina shall be submitted to the State Value Management Engineer no later than ten (10) business days after acceptance of a VEP unless otherwise permitted.

**Page 1-38, Subarticle 104-12(F) Modifications, line 17,** add the following at the end of the third paragraph:

Supplemental agreements executed for design-bid-build contracts shall reflect any realized savings in the corresponding line items. Supplemental agreements executed for design-build contracts shall add one line item deducting the full savings from the total contract price and one line item crediting the Contractor with 50% of the total VEP savings.

**Page 1-38, Subarticle 104-12(F) Modifications, lines 45-47,** replace the eighth paragraph with the following:

Unless and until a supplemental agreement is executed and issued by the Department and final plans (hard copy and electronic) sealed by an engineer licensed in the State of North Carolina incorporating an approved VEP have been provided to the Resident Engineer and the State Value Management Engineer, the Contractor shall remain obligated to perform the work in accordance with the terms of the existing contract.

**RESOURCE CONSERVATION AND ENV. SUSTAINABLE PRACTICES:**

(5-21-13) (Rev. 5-19-15)

104-13

SPI G118

In accordance with North Carolina Executive Order 156, NCGS 130A-309.14(3), and NCGS 136-28.8, it is the objective of the Department to aid in the reduction of materials that become a part of our solid waste stream, to divert materials from landfills, to find ways to recycle and reuse materials, to consider and minimize, where economically feasible, the environmental impacts associated with agency land use and acquisition, construction, maintenance and facility management for the benefit of the Citizens of North Carolina.

To achieve the mission of reducing environmental impacts across the state, the Department is committed to supporting the efforts to initiate, develop and use products and construction methods that incorporate the use of recycled, solid waste products and environmentally sustainable practices in accordance with Article 104-13 of the *Standard Specifications*.

Report the quantities of reused or recycled materials either incorporated in the project or diverted from landfills and any practice that minimizes the environmental impact on the project annually



on the Project Construction Reuse and Recycling Reporting Form. The Project Construction Reuse and Recycling Reporting Form and a location tool for local recycling facilities are available at:

<http://connect.ncdot.gov/resources/Environmental/Pages/North-Carolina-Recycling-Locations.aspx>.

Submit the Project Construction Reuse and Recycling Reporting Form by August 1 annually to [valuemanagementunit@ncdot.gov](mailto:valuemanagementunit@ncdot.gov). For questions regarding the form or reporting, please contact the State Value Management Engineer at 919-707-4810.

**DOMESTIC STEEL:**

(4-16-13)

106

SP1 G120

Revise the *2012 Standard Specifications* as follows:

**Page 1-49, Subarticle 106-1(B) Domestic Steel, lines 2-7,** replace the first paragraph with the following:

All steel and iron products that are permanently incorporated into this project shall be produced in the United States except minimal amounts of foreign steel and iron products may be used provided the combined material cost of the items involved does not exceed 0.1% of the total amount bid for the entire project or \$2,500, whichever is greater. If invoices showing the cost of the material are not provided, the amount of the bid item involving the foreign material will be used for calculations. This minimal amount of foreign produced steel and iron products permitted for use is not applicable to high strength fasteners. Domestically produced high strength fasteners are required.

**OUTSOURCING OUTSIDE THE USA:**

(9-21-04) (Rev. 5-16-06)

SP1 G150

All work on consultant contracts, services contracts, and construction contracts shall be performed in the United States of America. No work shall be outsourced outside of the United States of America.

*Outsourcing* for the purpose of this provision is defined as the practice of subcontracting labor, work, services, staffing, or personnel to entities located outside of the United States.

The North Carolina Secretary of Transportation shall approve exceptions to this provision in writing.

**IRAN DIVESTMENT ACT:**

(5-17-16)

SP01 G151

As a result of the Iran Divestment Act of 2015 (Act), Article 6E, N.C. General Statute § 147-86.55, the State Treasurer published the Final Divestment List (List) which includes the Final Divestment List-Iran, and the Parent and Subsidiary Guidance-Iran. These lists identify companies and persons engaged in investment activities in Iran and will be updated every 180

days. The List can be found at <https://www.nctreasurer.com/inside-the-department/OpenGovernment/Pages/Iran-Divestment-Act-Resources.aspx>

By submitting the Offer, the Contractor certifies that, as of the date of this bid, it is not on the then-current List created by the State Treasurer. The Contractor must notify the Department immediately if, at any time before the award of the contract, it is added to the List.

As an ongoing obligation, the Contractor must notify the Department immediately if, at any time during the contract term, it is added to the List. Consistent with § 147-86.59, the Contractor shall not contract with any person to perform a part of the work if, at the time the subcontract is signed, that person is on the then-current List.

During the term of the Contract, should the Department receive information that a person is in violation of the Act as stated above, the Department will offer the person an opportunity to respond and the Department will take action as appropriate and provided for by law, rule, or contract.

#### **GIFTS FROM VENDORS AND CONTRACTORS:**

(12-15-09)

107-1

SP1 G152

By Executive Order 24, issued by Governor Perdue, and *N.C.G.S. § 133-32*, it is unlawful for any vendor or contractor (i.e. architect, bidder, contractor, construction manager, design professional, engineer, landlord, offeror, seller, subcontractor, supplier, or vendor), to make gifts or to give favors to any State employee of the Governor's Cabinet Agencies (i.e. Administration, Commerce, Correction, Crime Control and Public Safety, Cultural Resources, Environment and Natural Resources, Health and Human Services, Juvenile Justice and Delinquency Prevention, Revenue, Transportation, and the Office of the Governor). This prohibition covers those vendors and contractors who:

- (A) Have a contract with a governmental agency; or
- (B) Have performed under such a contract within the past year; or
- (C) Anticipate bidding on such a contract in the future.

For additional information regarding the specific requirements and exemptions, vendors and contractors are encouraged to review Executive Order 24 and *N.C.G.S. § 133-32*.

Executive Order 24 also encouraged and invited other State Agencies to implement the requirements and prohibitions of the Executive Order to their agencies. Vendors and contractors should contact other State Agencies to determine if those agencies have adopted Executive Order 24.

**LIABILITY INSURANCE:**

(5-20-14)

SP1 G160

Revise the *2012 Standard Specifications* as follows:

**Page 1-60, Article 107-15 LIABILITY INSURANCE, line 16**, add the following as the second sentence of the third paragraph:

Prior to beginning services, all contractors shall provide proof of coverage issued by a workers' compensation insurance carrier, or a certificate of compliance issued by the Department of Insurance for self-insured subcontractors, irrespective of whether having regularly in service fewer than three employees.

**EMPLOYMENT:**

(11-15-11) (Rev. 1-17-12)

108, 102

SP1 G184

Revise the *2012 Standard Specifications* as follows:

**Page 1-20, Subarticle 102-15(O)**, delete and replace with the following:

**(O)** Failure to restrict a former Department employee as prohibited by Article 108-5.

**Page 1-65, Article 108-5 Character of Workmen, Methods, and Equipment, line 32**, delete all of line 32, the first sentence of the second paragraph and the first word of the second sentence of the second paragraph.

**STATE HIGHWAY ADMINISTRATOR TITLE CHANGE:**

(9-18-12)

SP1 G185

Revise the *2012 Standard Specifications* as follows:

Replace all references to "State Highway Administrator" with "Chief Engineer".

**SUBLETTING OF CONTRACT:**

(11-18-2014)

108-6

SP1 G186

Revise the *2012 Standard Specifications* as follows:

**Page 1-66, Article 108-6 Subletting of Contract, line 37**, add the following as the second sentence of the first paragraph:

All requests to sublet work shall be submitted within 30 days of the date of availability or prior to expiration of 20% of the contract time, whichever date is later, unless otherwise approved by the Engineer.

**Page 1-67, Article 108-6 Subletting of Contract, line 7,** add the following as the second sentence of the fourth paragraph:

Purchasing materials for subcontractors is not included in the percentage of work required to be performed by the Contractor. If the Contractor sublets items of work but elects to purchase material for the subcontractor, the value of the material purchased will be included in the total dollar amount considered to have been sublet.

**PROJECT SPECIAL PROVISIONS****ROADWAY****BURNING RESTRICTIONS:**

(7-1-95)

200, 210, 215

SP2 R05

Open burning is not permitted on any portion of the right-of-way limits established for this project. Do not burn the clearing, grubbing or demolition debris designated for disposal and generated from the project at locations within the project limits, off the project limits or at any waste or borrow sites in this county. Dispose of the clearing, grubbing and demolition debris by means other than burning, according to state or local rules and regulations.

**MATERIALS:**

(2-21-12) (Rev. 11-22-16)

1000, 1002, 1005, 1016, 1018, 1024, 1050, 1074, 1078, 1080, 1081, 1086, 1084, 1087, 1092

SP10 R01

Revise the *2012 Standard Specifications* as follows:

**Page 10-1, Article 1000-1, DESCRIPTION, lines 9-10**, replace the last sentence of the first paragraph with the following:

Type IL, IP, IS or IT blended cement may be used instead of Portland cement.

**Page 10-1, Article 1000-1, DESCRIPTION, line 14**, add the following:

If any change is made to the mix design, submit a new mix design (with the exception of an approved pozzolan source change).

If any major change is made to the mix design, also submit new test results showing the mix design conforms to the criteria. Define a major change to the mix design as:

- (1) A source change in coarse aggregate, fine aggregate or cement.
- (2) A pozzolan class or type change (e.g. Class F fly ash to Class C fly ash).
- (3) A quantitative change in coarse aggregate (applies to an increase or decrease greater than 5%), fine aggregate (applies to an increase or decrease greater than 5%), water (applies to an increase only), cement (applies to a decrease only), or pozzolan (applies to an increase or decrease greater than 5%).

Use materials which do not produce a mottled appearance through rusting or other staining of the finished concrete surface.

**Page 10-1, Article 1000-2, MATERIALS, line 16; Page 10-8, Subarticle 1000-7(A), Materials, line 8; and Page 10-18, Article 1002-2, MATERIALS, line 9**, add the following to the table of item references:

**Item****Section**

Type II Blended Cement

1024-1

**Page 10-1, Subarticle 1000-3(A), Composition and Design, lines 25-27,** replace the second paragraph with the following:

Fly ash may be substituted for cement in the mix design up to 30% at a rate of 1.0 lb of fly ash to each pound of cement replaced.

**Page 10-2, Subarticle 1000-3(A), Composition and Design, lines 12-21,** delete the third paragraph through the sixth paragraph beginning with “If any change is made to the mix design, submit...” through “...(applies to a decrease only).”

**Page 10-5, Table 1000-1, REQUIREMENTS FOR CONCRETE,** replace with the following:

TABLE 1000-1 REQUIREMENTS FOR CONCRETE											
Class of Concrete	Min. Comp. Strength at 28 days	Maximum Water-Cement Ratio				Consistency Max. Slump		Cement Content			
		Air-Entrained Concrete		Non Air-Entrained Concrete		Vibrated	Non-Vibrated	Vibrated		Non-Vibrated	
		Rounded Aggregate	Angular Aggregate	Rounded Aggregate	Angular Aggregate			Min.	Max.	Min.	Max.
Units	psi					inch	inch	lb/cy	lb/cy	lb/cy	lb/cy
AA	4,500	0.381	0.426	-	-	3.5	-	639	715	-	-
AA Slip Form	4,500	0.381	0.426	-	-	1.5	-	639	715	-	-
Drilled Pier	4,500	-	-	0.450	0.450	-	5-7 dry 7-9 wet	-	-	640	800
A	3,000	0.488	0.532	0.550	0.594	3.5	4	564	-	602	-
B	2,500	0.488	0.567	0.559	0.630	1.5 machine-placed 2.5 hand-placed	4	508	-	545	-
Sand Lightweight	4,500	-	0.420	-	-	4	-	715	-	-	-
Latex Modified	3,000 7 day	0.400	0.400	-	-	6	-	658	-	-	-
Flowable Fill excavatable	150 max. at 56 days	as needed	as needed	as needed	as needed	-	Flowable	-	-	40	100
Flowable Fill non-excavatable	125	as needed	as needed	as needed	as needed	-	Flowable	-	-	100	as needed
Pavement	4,500 design, field 650 flexural, design only	0.559	0.559	-	-	1.5 slip form 3.0 hand place	-	526	-	-	-
Precast	See Table 1077-1	as needed	as needed	-	-	6	as needed	as needed	as needed	as needed	as needed
Prestress	per contract	See Table 1078-1	See Table 1078-1	-	-	8	-	564	as needed	-	-

**Page 10-6, Subarticle 1000-4(I), Use of Fly Ash, lines 36-2,** replace the first paragraph with the following:

Fly ash may be substituted for cement in the mix design up to 30% at a rate of 1.0 lb of fly ash to each pound of cement replaced. Use Table 1000-1 to determine the maximum allowable water-cementitious material (cement + fly ash) ratio for the classes of concrete listed.

**Page 10-7, Table 1000-3, MAXIMUM WATER-CEMENTITIOUS MATERIAL RATIO,** delete the table.

**Page 10-7, Article 1000-5, HIGH EARLY STRENGTH PORTLAND CEMENT CONCRETE, lines 30-31,** delete the second sentence of the third paragraph.

**Page 10-19, Article 1002-3, SHOTCRETE FOR TEMPORARY SUPPORT OF EXCAVATIONS, line 30,** add the following at the end of Section 1002:

**(H) Handling and Storing Test Panels**

Notify the Area Materials Engineer when preconstruction or production test panels are made within 24 hours of shooting the panels. Field cure and protect test panels from damage in accordance with ASTM C1140 until the Department transports panels to the Materials and Tests Regional Laboratory for coring.

Page 10-23, Table 1005-1, AGGREGATE GRADATION-COARSE AGGREGATE, replace with the following:

TABLE 1005-1 AGGREGATE GRADATION - COARSE AGGREGATE													
Percentage of Total by Weight Passing													
Std. Size #	2"	1 1/2"	1"	3/4"	1/2"	3/8"	#4	#8	#10	#16	#40	#200	Remarks
4	100	90-100	20-55	0-15	-	0-5	-	-	-	-	-	A	Asphalt Plant Mix
467M	100	95-100	-	35-70	-	0-30	0-5	-	-	-	-	A	Asphalt Plant Mix
5	-	100	90-100	20-55	0-10	0-5	-	-	-	-	-	A	AST, Sediment Control Stone
57	-	100	95-100	-	25-60	-	0-10	0-5	-	-	-	A	AST, Structural Concrete, Shoulder Drain Stone, Sediment Control Stone
57M	-	100	95-100	-	25-45	-	0-10	0-5	-	-	-	A	AST, Concrete Pavement
6M	-	-	100	90-100	20-55	0-20	0-8	-	-	-	-	A	AST
67	-	-	100	90-100	-	20-55	0-10	0-5	-	-	-	A	Asphalt Plant Mix, AST, Structural Concrete
78M	-	-	-	100	98-100	75-100	20-45	0-15	-	-	-	A	Asphalt Plant Mix, AST, Structural Concrete, Weep Hole Drains
14M	-	-	-	-	100	98-100	35-70	5-20	-	0-8	-	A	Asphalt Plant Mix, AST, Structural Concrete, Weep Hole Drains
9M	-	-	-	-	100	98-100	85-100	10-40	-	0-10	-	A	AST
ABC	-	100	75-97	-	55-80	-	35-55	-	25-45	-	14-30	4-12 <sup>B</sup>	Aggregate Base Course, Aggregate Stabilization
ABC(M)	-	100	75-100	-	45-79	-	20-40	-	0-25	-	-	0-12 <sup>B</sup>	Maintenance Stabilization
Light-C weight	-	-	-	-	100	80-100	5-40	0-20	-	0-10	-	0-2.5	AST

- A. See Subarticle 1005-4(A).
- B. See Subarticle 1005-4(B).
- C. For Lightweight Aggregate used in Structural Concrete, see Subarticle 1014-2(E)(6).



**Page 10-39, Article 1016-3, CLASSIFICATIONS , lines 27-32, replace with the following:**

Select material is clean, unweathered durable, blasted rock material obtained from an approved source. While no specific gradation is required, the below criteria will be used to evaluate the materials for visual acceptance by the Engineer:

- (A) At least 50% of the rock has a diameter of from 1.5 ft to 3 ft,
- (B) 30% of the rock ranges in size from 2” to 1.5 ft in diameter, and
- (C) Not more than 20% of the rock is less than 2” in diameter. No rippable rock will be permitted.

**Page 10-40, Tables 1018-1 and 1018-2, PIEDMONT, WESTERN AND COASTAL AREA CRITERIA FOR ACCEPTANCE OF BORROW MATERIAL, under second column in both tables, replace second row with the following:**

Acceptable, but not to be used in the top 3 ft of embankment or backfill

**Page 10-46, Article 1024-1, PORTLAND CEMENT, line 33, add the following as the ninth paragraph:**

Use Type IL blended cement that meets AASHTO M 240, except that the limestone content is limited to between 5 and 12% by weight and the constituents shall be interground. Class F fly ash can replace a portion of Type IL blended cement and shall be replaced as outlined in Subarticle 1000-4(I) for Portland cement. For mixes that contain cement with alkali content between 0.6% and 1.0% and for mixes that contain a reactive aggregate documented by the Department, use a pozzolan in the amount shown in Table 1024-1.

**Page 10-46, Table 1024-1, POZZOLANS FOR USE IN PORTLAND CEMENT CONCRETE, replace with the following:**

<b>TABLE 1024-1 POZZOLANS FOR USE IN PORTLAND CEMENT CONCRETE</b>	
<b>Pozzolan</b>	<b>Rate</b>
Class F Fly Ash	20% - 30% by weight of required cement content with 1.0 lb Class F fly ash per lb of cement replaced
Ground Granulated Blast Furnace Slag	35%-50% by weight of required cement content with 1.0 lb slag per lb of cement replaced
Microsilica	4%-8% by weight of required cement content with 1.0 lb microsilica per lb of cement replaced

**Page 10-47, Subarticle 1024-3(B), Approved Sources, lines 16-18, replace the second sentence of the second paragraph with the following:**

Tests shall be performed by AASHTO's designated National Transportation Product Evaluation Program (NTPEP) laboratory for concrete admixture testing.

**Page 10-65, Article 1050-1, GENERAL, line 41,** replace the first sentence with the following:

All fencing material and accessories shall meet Section 106.

**Page 10-115, Subarticle 1074-7(B), Gray Iron Castings, lines 10-11,** replace the first two sentences with the following:

Supply gray iron castings meeting all facets of AASHTO M 306 excluding proof load. Proof load testing will only be required for new casting designs during the design process, and conformance to M306 loading (40,000 lb.) will be required only when noted on the design documents.

**Page 10-126, Table 1078-1, REQUIREMENTS FOR CONCRETE,** replace with the following:

<b>TABLE 1078-1 REQUIREMENTS FOR CONCRETE</b>		
<b>Property</b>	<b>28 Day Design Compressive Strength 6,000 psi or less</b>	<b>28 Day Design Compressive Strength greater than 6,000 psi</b>
Maximum Water/Cementitious Material Ratio	0.45	0.40
Maximum Slump without HRWR	3.5"	3.5"
Maximum Slump with HRWR	8"	8"
Air Content (upon discharge into forms)	5 + 2%	5 + 2%

**Page 10-151, Article 1080-4, INSPECTION AND SAMPLING, lines 18-22,** replace (B), (C) and (D) with the following:

- (B) At least 3 panels prepared as specified in 5.5.10 of AASHTO M 300, Bullet Hole Immersion Test.
- (C) At least 3 panels of 4"x6"x1/4" for the Elcometer Adhesion Pull Off Test, ASTM D4541.
- (D) A certified test report from an approved independent testing laboratory for the Salt Fog Resistance Test, Cyclic Weathering Resistance Test, and Bullet Hole Immersion Test as specified in AASHTO M 300.
- (E) A certified test report from an approved independent testing laboratory that the product has been tested for slip coefficient and meets AASHTO M253, Class B.

**Page 10-161, Subarticle 1081-1(A), Classifications, lines 29-33**, delete first 3 sentences of the description for Type 2 and replace with the following:

**Type 2** - A low-modulus, general-purpose adhesive used in epoxy mortar repairs. It may be used to patch spalled, cracked or broken concrete where vibration, shock or expansion and contraction are expected.

**Page 10-162, Subarticle 1081-1(A), Classifications, lines 4-7**, delete the second and third sentences of the description for Type 3A. **Lines 16-22**, delete Types 6A, 6B and 6C.

**Page 10-162, Subarticle 1081-1(B), Requirements, lines 26-30**, replace the second paragraph with the following:

For epoxy resin systems used for embedding dowel bars, threaded rods, rebar, anchor bolts and other fixtures in hardened concrete, the manufacturer shall submit test results showing that the bonding system will obtain 125% of the specified required yield strength of the fixture. Furnish certification that, for the particular bolt grade, diameter and embedment depth required, the anchor system will not fail by adhesive failure and that there is no movement of the anchor bolt. For certification and anchorage, use 3,000 psi as the minimum Portland cement concrete compressive strength used in this test. Use adhesives that meet Section 1081.

List the properties of the adhesive on the container and include density, minimum and maximum temperature application, setting time, shelf life, pot life, shear strength and compressive strength.

Page 10-163, Table 1081-1, PROPERTIES OF MIXED EPOXY RESIN SYSTEMS, replace with the following:

Property	Type 1	Type 2	Type 3	Type 3A	Type 4A	Type 4B	Type 5
Viscosity-Poises at 77°F ± 2°F	Gel	10-30	25-75	Gel	40-150	40-150	1-6
Spindle No.	-	3	4	--	4	4	2
Speed (RPM)	-	20	20	--	10	10	50
Pot Life (Minutes)	20-50	30-60	20-50	5-50	40-80	40-80	20-60
Minimum Tensile Strength at 7 days (psi)	1,500	2,000	4,000	4,000	1,500	1,500	4,000
Tensile Elongation at 7 days (%)	30 min.	30 min.	2-5	2-5	5-15	5-15	2-5
Min. Compressive Strength of 2" mortar cubes at 24 hours	3,000 (Neat)	4,000-	6,000-	6,000 (Neat)	3,000	3,000	6,000
Min. Compressive Strength of 2" mortar cubes at 7 days	5,000 (Neat)	-	-	-	-	5,000	-
Maximum Water Absorption (%)	1.5	1.0	1.0	1.5	1.0	1.0	1.0
Min. Bond Strength Slant Shear Test at 14 days (psi)	1,500	1,500	2,000	2,000	1,500	1,500	1,500

Page 10-164, Subarticle 1081-1(E), Prequalification, lines 31-33, replace the second sentence of the first paragraph with the following:

Manufacturers choosing to supply material for Department jobs must submit an application through the Value Management Unit with the following information for each type and brand name:

**Page 10-164, Subarticle 1081-1(E)(3), line 37**, replace with the following:

(3) Type of the material in accordance with Articles 1081-1 and 1081-4,

**Page 10-165, Subarticle 1081-1(E)(6), line 1**, in the first sentence of the first paragraph replace “AASHTO M 237” with “the specifications”.

**Page 10-165, Subarticle 1081-1(E), Prequalification, line 9-10**, delete the second sentence of the last paragraph.

**Page 10-165, Subarticle 1081-1(F), Acceptance, line 14**, in the first sentence of the first paragraph replace “Type 1” with “Type 3”.

**Page 10-169, Subarticle 1081-3(G), Anchor Bolt Adhesives**, delete this subarticle.

**Page 10-170, Article 1081-3, HOT BITUMEN, line 9**, add the following at the end of Section 1081:

#### **1081-4 EPOXY RESIN ADHESIVE FOR BONDING TRAFFIC MARKINGS**

##### **(A) General**

This section covers epoxy resin adhesive for bonding traffic markers to pavement surfaces.

##### **(B) Classification**

The types of epoxies and their uses are as shown below:

**Type I** – Rapid Setting, High Viscosity, Epoxy Adhesive. This type of adhesive provides rapid adherence to traffic markers to the surface of pavement.

**Type II** – Standard Setting, High Viscosity, Epoxy Adhesive. This type of adhesive is recommended for adherence of traffic markers to pavement surfaces when rapid set is not required.

**Type III** – Rapid Setting, Low Viscosity, Water Resistant, Epoxy Adhesive. This type of rapid setting adhesive, due to its low viscosity, is appropriate only for use with embedded traffic markers.

**Type IV** – Standard Set Epoxy for Blade Deflecting-Type Plowable Markers.

##### **(C) Requirements**

Epoxies shall conform to the requirements set forth in AASHTO M 237.

##### **(D) Prequalification**

Refer to Subarticle 1081-1(E).

##### **(E) Acceptance**

Refer to Subarticle 1081-1(F).

**Page 10-173, Article 1084-2, STEEL SHEET PILES, lines 37-38**, replace first paragraph with the following:

Steel sheet piles detailed for permanent applications shall be hot rolled and meet ASTM A572 or ASTM A690 unless otherwise required by the plans. Steel sheet piles shall be coated as required

by the plans. Galvanized sheet piles shall be coated in accordance with Section 1076. Metallized sheet piles shall be metallized in accordance to the Project Special Provision “Thermal Sprayed Coatings (Metallization)” with an 8 mil, 99.9% aluminum alloy coating and a 0.5 mil seal coating. Any portion of the metallized sheet piling encased in concrete shall receive a barrier coat. The barrier coat shall be an approved waterborne coating with a low-viscosity which readily absorbs into the pores of the aluminum thermal sprayed coating. The waterborne coating shall be applied at a spreading rate that results in a theoretical 1.5 mil dry film thickness. The manufacturer shall issue a letter of certification that the resin chemistry of the waterborne coating is compatible with the 99.9% aluminum thermal sprayed alloy and suitable for tidal water applications.

**Page 10-174, Subarticle 1086-1(B)(1), Epoxy, lines 18-24,** replace with the following:

The epoxy shall meet Article 1081-4.

The 2 types of epoxy adhesive which may be used are Type I, Rapid Setting, and Type II, Standard Setting. Use Type II when the pavement temperature is above 60°F or per the manufacturer’s recommendations whichever is more stringent. Use Type I when the pavement temperature is between 50°F and 60°F or per the manufacturer’s recommendations whichever is more stringent. Epoxy adhesive Type I, Cold Set, may be used to attach temporary pavement markers to the pavement surface when the pavement temperature is between 32°F and 50°F or per the manufacturer’s recommendations whichever is more stringent.

**Page 10-175, Subarticle 1086-2(E), Epoxy Adhesives, line 27,** replace “Section 1081” with “Article 1081-4”.

**Page 10-177, Subarticle 1086-3(E), Epoxy Adhesives, line 22,** replace “Section 1081” with “Article 1081-4”.

**Page 10-179, Subarticle 1087-4(A), Composition, lines 39-41,** replace the third paragraph with the following:

All intermixed and drop-on glass beads shall not contain more than 75 ppm arsenic or 200 ppm lead.

**Page 10-180, Subarticle 1087-4(B), Physical Characteristics, line 8,** replace the second paragraph with the following:

All intermixed and drop-on glass beads shall comply with NCGS § 136-30.2 and 23 USC § 109(r).

**Page 10-181, Subarticle 1087-7(A), Intermixed and Drop-on Glass Beads, line 24,** add the following after the first paragraph:

Use X-ray Fluorescence for the normal sampling procedure for intermixed and drop-on beads, without crushing, to check for any levels of arsenic and lead. If any arsenic or lead is detected, the sample shall be crushed and repeat the test using X-ray Fluorescence. If the X-ray Fluorescence test shows more than a LOD of 5 ppm, test the beads using United States Environmental Protection Agency Method 6010B, 6010C or 3052 for no more than 75 ppm arsenic or 200 ppm lead.

**GROUT PRODUCTION AND DELIVERY:**

(3-17-15)

1003

SP10 R20

Revise the *2012 Standard Specifications* as follows:

Replace Section 1003 with the following:

**SECTION 1003  
GROUT PRODUCTION AND DELIVERY**

**1003-1 DESCRIPTION**

This section addresses cement grout to be used for structures, foundations, retaining walls, concrete barriers, embankments, pavements and other applications in accordance with the contract. Produce non-metallic grout composed of Portland cement and water and at the Contractor's option or as required, aggregate and pozzolans. Include chemical admixtures as required or needed. Provide sand cement or neat cement grout as required. Define "sand cement grout" as grout with only fine aggregate and "neat cement grout" as grout without aggregate.

The types of grout with their typical uses are as shown below:

**Type 1** – A cement grout with only a 3-day strength requirement and a fluid consistency that is typically used for filling subsurface voids.

**Type 2** – A nonshrink grout with strength, height change and flow conforming to ASTM C1107 that is typically used for foundations, ground anchors and soil nails.

**Type 3** – A nonshrink grout with high early strength and freeze-thaw durability requirements that is typically used in pile blockouts, grout pockets, shear keys, dowel holes and recesses for concrete barriers and structures.

**Type 4** – A neat cement grout with low strength, a fluid consistency and high fly ash content that is typically used for slab jacking.

**Type 5** – A low slump, low mobility sand cement grout with minimal strength that is typically used for compaction grouting.

**1003-2 MATERIALS**

Refer to Division 10.

<b>Item</b>	<b>Section</b>
Chemical Admixtures	1024-3
Fine Aggregate	1014-1
Fly Ash	1024-5
Ground Granulated Blast Furnace Slag	1024-6
Portland Cement	1024-1

Silica Fume  
Water

1024-7  
1024-4

Do not use grout that contains soluble chlorides or more than 1% soluble sulfate. At the Contractor's option, use an approved packaged grout instead of the materials above except for water. Use packaged grouts that are on the NCDOT Approved Products List.

Use admixtures for grout that are on the NCDOT Approved Products List or other admixtures in accordance with Subarticle 1024-3(E) except do not use concrete additives or unclassified or other admixtures in Type 4 or 5 grout. Use Class F fly ash for Type 4 grout and Type II Portland cement for Type 5 grout.

Use well graded rounded aggregate with a gradation, liquid limit (LL) and plasticity index (PI) that meet Table 1003-1 for Type 5 grout. Fly ash may be substituted for a portion of the fines in the aggregate. Do not use any other pozzolans in Type 5 grout.

<b>TABLE 1003-1</b>			
<b>AGGREGATE REQUIREMENTS FOR TYPE 5 GROUT</b>			
<b>Gradation</b>		<b>Maximum Liquid Limit</b>	<b>Maximum Plasticity Index</b>
<b>Sieve Designation per AASHTO M 92</b>	<b>Percentage Passing (% by weight)</b>		
3/8"	100	N/A	N/A
No. 4	70 – 95		
No. 8	50 – 90		
No. 16	30 – 80		
No. 30	25 – 70		
No. 50	20 – 50		
No. 100	15 – 40		
No. 200	10 – 30	25	10

### **1003-3 COMPOSITION AND DESIGN**

When using an approved packaged grout, a grout mix design submittal is not required. Otherwise, submit proposed grout mix designs for each grout mix to be used in the work. Mixes for all grout shall be designed by a Certified Concrete Mix Design Technician or an Engineer licensed by the State of North Carolina. Mix proportions shall be determined by a testing laboratory approved by the Department. Base grout mix designs on laboratory trial batches that meet Table 1003-2 and this section. With permission, the Contractor may use a quantity of chemical admixture within the range shown on the current list of approved admixtures maintained by the Materials and Tests Unit.

Submit grout mix designs in terms of saturated surface dry weights on Materials and Tests Form 312U at least 35 days before proposed use. Adjust batch proportions to compensate for surface moisture contained in the aggregates at the time of batching.



Changes in the saturated surface dry mix proportions will not be permitted unless revised grout mix designs have been submitted to the Engineer and approved.

Accompany Materials and Tests Form 312U with a listing of laboratory test results of compressive strength, density and flow or slump and if applicable, aggregate gradation, durability and height change. List the compressive strength of at least three 2" cubes at the age of 3 and 28 days.

The Engineer will review the grout mix design for compliance with the contract and notify the Contractor as to its acceptability. Do not use a grout mix until written notice has been received. Acceptance of the grout mix design or use of approved packaged grouts does not relieve the Contractor of his responsibility to furnish a product that meets the contract. Upon written request from the Contractor, a grout mix design accepted and used satisfactorily on any Department project may be accepted for use on other projects.

Perform laboratory tests in accordance with the following test procedures:

<b>Property</b>	<b>Test Method</b>
Aggregate Gradation <sup>A</sup>	AASHTO T 27
Compressive Strength	AASHTO T 106
Density (Unit Weight)	AASHTO T 121, AASHTO T 133 <sup>B</sup> , ANSI/API RP <sup>C</sup> 13B-1 <sup>B</sup> (Section 4, Mud Balance)
Durability	AASHTO T 161 <sup>D</sup>
Flow	ASTM C939 (Flow Cone)
Height Change	ASTM C1090 <sup>E</sup>
Slump	AASHTO T 119

**A.** Applicable to grout with aggregate.

**B.** Applicable to Neat Cement Grout.

**C.** American National Standards Institute/American Petroleum Institute Recommended Practice.

**D.** Procedure A (Rapid Freezing and Thawing in Water) required.

**E.** Moist room storage required.

#### **1003-4 GROUT REQUIREMENTS**

Provide grout types in accordance with the contract. Use grouts with properties that meet Table 1003-2. The compressive strength of the grout will be considered the average compressive strength test results of three 2" cubes at each age. Make cubes that meet AASHTO T 106 from the grout delivered for the work or mixed on-site. Make cubes at such frequencies as the Engineer may determine and cure them in accordance with AASHTO T 106.

Type of Grout	Minimum Compressive Strength at		Height Change at 28 days	Flow <sup>A</sup> /Slump <sup>B</sup>	Minimum Durability Factor
	3 days	28 days			
1	3,000 psi	–	–	10 – 30 sec	–
2	Table 1 <sup>C</sup>			Fluid Consistency <sup>C</sup>	–
3	5,000 psi	–	0 – 0.2%	Per Accepted Grout Mix Design/ Approved Packaged Grout	80
4 <sup>D</sup>	600 psi	1,500 psi	–	10 – 26 sec	–
5	–	500 psi	–	1 – 3"	–

A. Applicable to Type 1 through 4 grouts.

B. Applicable to Type 5 grout.

C. ASTM C1107.

D. Use Type 4 grout with proportions by volume of 1 part cement and 3 parts fly ash.

### 1003-5 TEMPERATURE REQUIREMENTS

When using an approved packaged grout, follow the manufacturer's instructions for grout and air temperature at the time of placement. Otherwise, the grout temperature at the time of placement shall be not less than 50°F nor more than 90°F. Do not place grout when the air temperature measured at the location of the grouting operation in the shade away from artificial heat is below 40°F.

### 1003-6 ELAPSED TIME FOR PLACING GROUT

Agitate grout continuously before placement. Regulate the delivery so the maximum interval between the placing of batches at the work site does not exceed 20 minutes. Place grout before exceeding the times in Table 1003-3. Measure the elapsed time as the time between adding the mixing water to the grout mix and placing the grout.

Air or Grout Temperature, Whichever is Higher	Maximum Elapsed Time	
	No Retarding Admixture Used	Retarding Admixture Used
90°F or above	30 minutes	1 hr. 15 minutes
80°F through 89°F	45 minutes	1 hr. 30 minutes
79°F or below	60 minutes	1 hr. 45 minutes

**1003-7 MIXING AND DELIVERY**

Use grout free of any lumps and undispersed cement. When using an approved packaged grout, mix grout in accordance with the manufacturer's instructions. Otherwise, comply with Articles 1000-8 through 1000-12 to the extent applicable for grout instead of concrete.

**TRUCK MOUNTED CHANGEABLE MESSAGE SIGNS:**

(8-21-12)

1101.02

SP11 R10

Revise the *2012 Roadway Standard Drawings* as follows:

**Drawing No. 1101.02, Sheet 12, TEMPORARY LANE CLOSURES**, replace General Note #11 with the following:

11- TRUCK MOUNTED CHANGEABLE MESSAGE SIGNS (TMCMS) USED ON SHADOW VEHICLES FOR "IN LANE" ACTIVITIES SHALL BE A MINIMUM OF 43" X 73". THE DISPLAY PANEL SHALL HAVE FULL MATRIX CAPABILITY WITH THE CAPABILITY TO PROVIDE 2 MESSAGE LINES WITH 7 CHARACTERS PER LINE WITH A MINIMUM CHARACTER HEIGHT OF 18". FOR ADDITIONAL MESSAGING, CONTACT THE WORK ZONE TRAFFIC CONTROL SECTION.

12- TMCMS USED FOR ADVANCED WARNING ON VEHICLES LOCATED ON THE SHOULDER MAY BE SMALLER THAN 43" X 73". THE DISPLAY PANEL SHALL HAVE THE CAPABILITY TO PROVIDE 2 MESSAGE LINES WITH 7 CHARACTERS PER LINE WITH A MINIMUM CHARACTER HEIGHT OF 18". FOR ADDITIONAL MESSAGING, CONTACT THE WORK ZONE TRAFFIC CONTROL SECTION.

**Drawing No. 1101.02, Sheet 13, TEMPORARY LANE CLOSURES**, replace General Note #12 with the following:

12- TRUCK MOUNTED CHANGEABLE MESSAGE SIGNS (TMCMS) USED ON SHADOW VEHICLES FOR "IN LANE" ACTIVITIES SHALL BE A MINIMUM OF 43" X 73". THE DISPLAY PANEL SHALL HAVE FULL MATRIX CAPABILITY WITH THE CAPABILITY TO PROVIDE 2 MESSAGE LINES WITH 7 CHARACTERS PER LINE WITH A MINIMUM CHARACTER HEIGHT OF 18". FOR ADDITIONAL MESSAGING, CONTACT THE WORK ZONE TRAFFIC CONTROL SECTION.

13- TMCMS USED FOR ADVANCED WARNING ON VEHICLES LOCATED ON THE SHOULDER MAY BE SMALLER THAN 43" X 73". THE DISPLAY PANEL SHALL HAVE THE CAPABILITY TO PROVIDE 2 MESSAGE LINES WITH 7 CHARACTERS PER LINE WITH A MINIMUM CHARACTER HEIGHT OF 18". FOR ADDITIONAL MESSAGING, CONTACT THE WORK ZONE TRAFFIC CONTROL SECTION.

**STANDARD SPECIAL PROVISION**  
**AVAILABILITY OF FUNDS – TERMINATION OF CONTRACTS**

(5-20-08)

Z-2

*General Statute 143C-6-11. (h) Highway Appropriation* is hereby incorporated verbatim in this contract as follows:

(h) Amounts Encumbered. – Transportation project appropriations may be encumbered in the amount of allotments made to the Department of Transportation by the Director for the estimated payments for transportation project contract work to be performed in the appropriation fiscal year. The allotments shall be multiyear allotments and shall be based on estimated revenues and shall be subject to the maximum contract authority contained in *General Statute 143C-6-11(c)*. Payment for transportation project work performed pursuant to contract in any fiscal year other than the current fiscal year is subject to appropriations by the General Assembly. Transportation project contracts shall contain a schedule of estimated completion progress, and any acceleration of this progress shall be subject to the approval of the Department of Transportation provided funds are available. The State reserves the right to terminate or suspend any transportation project contract, and any transportation project contract shall be so terminated or suspended if funds will not be available for payment of the work to be performed during that fiscal year pursuant to the contract. In the event of termination of any contract, the contractor shall be given a written notice of termination at least 60 days before completion of scheduled work for which funds are available. In the event of termination, the contractor shall be paid for the work already performed in accordance with the contract specifications.

Payment will be made on any contract terminated pursuant to the special provision in accordance with Subarticle 108-13(E) of the *2012 Standard Specifications*.

**STANDARD SPECIAL PROVISION****ERRATA**

(1-17-12) (Rev. 04-21-15)

Z-4

Revise the 2012 *Standard Specifications* as follows:

**Division 2**

**Page 2-7, line 31, Article 215-2 Construction Methods**, replace “Article 107-26” with “Article 107-25”.

**Page 2-17, Article 226-3, Measurement and Payment, line 2**, delete “pipe culverts,”.

**Page 2-20, Subarticle 230-4(B), Contractor Furnished Sources, change references as follows:** **Line 1**, replace “(4) Buffer Zone” with “(c) Buffer Zone”; **Line 12**, replace “(5) Evaluation for Potential Wetlands and Endangered Species” with “(d) Evaluation for Potential Wetlands and Endangered Species”; and **Line 33**, replace “(6) Approval” with “(4) Approval”.

**Division 3**

**Page 3-1, after line 15, Article 300-2 Materials**, replace “1032-9(F)” with “1032-6(F)”.

**Division 4**

**Page 4-77, line 27, Subarticle 452-3(C) Concrete Coping**, replace “sheet pile” with “reinforcement”.

**Division 6**

**Page 6-7, line 31, Article 609-3 Field Verification of Mixture and Job Mix Formula Adjustments**, replace “30” with “45”.

**Page 6-10, line 42, Subarticle 609-6(C)(2)**, replace “Subarticle 609-6(E)” with “Subarticle 609-6(D)”.

**Page 6-11, Table 609-1 Control Limits**, replace “Max. Spec. Limit” for the Target Source of  $P_{0.075}/P_{be}$  Ratio with “1.0”.

**Page 6-40, Article 650-2 Materials**, replace “Subarticle 1012-1(F)” with “Subarticle 1012-1(E)”

**Division 7**

**Page 7-1, Article 700-3, CONCRETE HAULING EQUIPMENT**, line 33, replace “competition” with “completion”.

**Division 8**

**Page 8-23, line 10, Article 838-2 Materials**, replace “Portland Cement Concrete, Class B” with “Portland Cement Concrete, Class A”.

**Division 10**

**Page 10-166, Article 1081-3 Hot Bitumen**, replace “Table 1081-16” with “Table 1081-2”, replace “Table 1081-17” with “Table 1081-3”, and replace “Table 1081-18” with “Table 1081-4”.

**Division 12**

**Page 12-7, Table 1205-3**, add “FOR THERMOPLASTIC” to the end of the title.

**Page 12-8, Subarticle 1205-5(B), line 13**, replace “Table 1205-2” with “Table 1205-4”.

**Page 12-8, Table 1205-4 and 1205-5**, replace “THERMOPLASTIC” in the title of these tables with “POLYUREA”.

**Page 12-9, Subarticle 1205-6(B), line 21**, replace “Table 1205-4” with “Table 1205-6”.

**Page 12-11, Subarticle 1205-8(C), line 25**, replace “Table 1205-5” with “Table 1205-7”.

**Division 15**

**Page 15-4, Subarticle 1505-3(F) Backfilling, line 26**, replace “Subarticle 235-4(C)” with “Subarticle 235-3(C)”.

**Page 15-6, Subarticle 1510-3(B), after line 21**, replace the allowable leakage formula with the following:  $W=LD\sqrt{P} \div 148,000$

**Page 15-6, Subarticle 1510-3(B), line 32**, delete “may be performed concurrently or” and replace with “shall be performed”.

**Page 15-17, Subarticle 1540-3(E), line 27**, delete “Type 1”.

**Division 17**

**Page 17-26, line 42, Subarticle 1731-3(D) Termination and Splicing within Interconnect Center**, delete this subarticle.

Revise the *2012 Roadway Standard Drawings* as follows:

**1633.01 Sheet 1 of 1, English Standard Drawing for Matting Installation**, replace “1633.01” with “1631.01”.

**STANDARD SPECIAL PROVISION****PLANT AND PEST QUARANTINES****(Imported Fire Ant, Gypsy Moth, Witchweed, Emerald Ash Borer, And Other Noxious Weeds)**

(3-18-03) (Rev. 12-20-16)

Z-04a

**Within Quarantined Area**

This project may be within a county regulated for plant and/or pests. If the project or any part of the Contractor's operations is located within a quarantined area, thoroughly clean all equipment prior to moving out of the quarantined area. Comply with federal/state regulations by obtaining a certificate or limited permit for any regulated article moving from the quarantined area.

**Originating in a Quarantined County**

Obtain a certificate or limited permit issued by the N.C. Department of Agriculture/United States Department of Agriculture. Have the certificate or limited permit accompany the article when it arrives at the project site.

**Contact**

Contact the N.C. Department of Agriculture/United States Department of Agriculture at 1-800-206-9333, 919-707-3730, or <http://www.ncagr.gov/plantindustry/> to determine those specific project sites located in the quarantined area or for any regulated article used on this project originating in a quarantined county.

**Regulated Articles Include**

1. Soil, sand, gravel, compost, peat, humus, muck, and decomposed manure, separately or with other articles. This includes movement of articles listed above that may be associated with cut/waste, ditch pulling, and shoulder cutting.
2. Plants with roots including grass sod.
3. Plant crowns and roots.
4. Bulbs, corms, rhizomes, and tubers of ornamental plants.
5. Hay, straw, fodder, and plant litter of any kind.
6. Clearing and grubbing debris.
7. Used agricultural cultivating and harvesting equipment.
8. Used earth-moving equipment.
9. Any other products, articles, or means of conveyance, of any character, if determined by an inspector to present a hazard of spreading imported fire ant, gypsy moth, witchweed, emerald ash borer, or other noxious weeds.

**STANDARD SPECIAL PROVISION**

**MINIMUM WAGES**

(7-21-09)

Z-5

**FEDERAL:** The Fair Labor Standards Act provides that with certain exceptions every employer shall pay wages at the rate of not less than SEVEN DOLLARS AND TWENTY FIVE CENTS (\$7.25) per hour.

**STATE:** The North Carolina Minimum Wage Act provides that every employer shall pay to each of his employees, wages at a rate of not less than SEVEN DOLLARS AND TWENTY FIVE CENTS (\$7.25) per hour.

The minimum wage paid to all skilled labor employed on this contract shall be SEVEN DOLLARS AND TWENTY FIVE CENTS (\$7.25) per hour.

The minimum wage paid to all intermediate labor employed on this contract shall be SEVEN DOLLARS AND TWENTY FIVE CENTS (\$7.25) per hour.

The minimum wage paid to all unskilled labor on this contract shall be SEVEN DOLLARS AND TWENTY FIVE CENTS (\$7.25) per hour.

This determination of the intent of the application of this act to the contract on this project is the responsibility of the Contractor.

The Contractor shall have no claim against the Department of Transportation for any changes in the minimum wage laws, Federal or State. It is the responsibility of the Contractor to keep fully informed of all Federal and State Laws affecting his contract.



**STANDARD SPECIAL PROVISION****AWARD OF CONTRACT**

(6-28-77)(Rev 2/16/2016)

Z-6

“The North Carolina Department of Transportation, in accordance with the provisions of *Title VI of the Civil Rights Act of 1964* (78 Stat. 252) and the Regulations of the Department of Transportation (*49 C.F.R., Part 21*), issued pursuant to such act, hereby notifies all bidders that it will affirmatively insure that the contract entered into pursuant to this advertisement will be awarded to the lowest responsible bidder without discrimination on the ground of race, color, or national origin”.

**TITLE VI AND NONDISCRIMINATION****I. Title VI Assurance**

During the performance of this contract, the contractor, for itself, its assignees and successors in interest (hereinafter referred to as the "contractor") agrees as follows:

**(1) Compliance with Regulations:** The contractor shall comply with the Regulation relative to nondiscrimination in Federally-assisted programs of the Department of Transportation (hereinafter, "DOT") Title 49, Code of Federal Regulations, Part 21, as they may be amended from time to time, (hereinafter referred to as the Regulations), which are herein incorporated by reference and made a part of this contract.

**(2) Nondiscrimination:** The Contractor, with regard to the work performed by it during the contract, shall not discriminate on the grounds of race, color, or national origin in the selection and retention of subcontractors, including procurements of materials and leases of equipment. The contractor shall not participate either directly or indirectly in the discrimination prohibited by section 21.5 of the Regulations, including employment practices when the contract covers a program set forth in Appendix B of the Regulations.

**(3) Solicitations for Subcontractors, Including Procurements of Materials and Equipment:** In all solicitations either by competitive bidding or negotiation made by the contractor for work to be performed under a subcontract, including procurements of materials or leases of equipment, each potential subcontractor or supplier shall be notified by the contractor of the contractor's obligations under this contract and the Regulations relative to nondiscrimination on the grounds of race, color, or national origin.

**(4) Information and Reports:** The contractor shall provide all information and reports required by the Regulations or directives issued pursuant thereto, and shall permit access to its books, records, accounts, other sources of information, and its facilities as may be determined by the North Carolina Department of Transportation (NCDOT) or the Federal Highway Administration (FHWA) to be pertinent to ascertain compliance with such Regulations, orders and instructions. Where any information required of a contractor is in the exclusive possession of another who fails or refuses to furnish this information the contractor shall so certify to the NCDOT, or the FHWA as appropriate, and shall set forth what efforts it has made to obtain the information.

**(5) Sanctions for Noncompliance:** In the event of the contractor's noncompliance with the nondiscrimination provisions of this contract, the NCDOT shall impose such contract sanctions as it or the FHWA may determine to be appropriate, including, but not limited to:

- (a) Withholding of payments to the contractor under the contract until the contractor complies, and/or
- (b) Cancellation, termination or suspension of the contract, in whole or in part.

**(6) Incorporation of Provisions:** The contractor shall include the provisions of paragraphs (1) through (6) in every subcontract, including procurements of materials and leases of equipment, unless exempt by the Regulations, or directives issued pursuant thereto.

The contractor shall take such action with respect to any subcontractor procurement as the NCDOT or the FHWA may direct as a means of enforcing such provisions including sanctions for noncompliance: provided, however, that, in the event a contractor becomes involved in, or is threatened with, litigation with a subcontractor or supplier as a result of such direction, the contractor may request the NCDOT to enter into such litigation to protect the interests of the NCDOT, and, in addition, the contractor may request the United States to enter into such litigation to protect the interests of the United States.

## **II. Title VI Nondiscrimination Program**

Title VI of the 1964 Civil Rights Act, 42 U.S.C. 2000d, provides that: "No person in the United States shall, on the grounds of race, color, or national origin, be excluded from participation in, be denied the benefits of, or be subjected to discrimination under any program or activity receiving Federal financial assistance." The broader application of nondiscrimination law is found in other statutes, executive orders, and regulations (see Section III, Pertinent Nondiscrimination Authorities), which provide additional protections based on age, sex, disability and religion. In addition, the 1987 Civil Rights Restoration Act extends nondiscrimination coverage to all programs and activities of federal-aid recipients and contractors, including those that are not federally-funded.

### *Nondiscrimination Assurance*

The North Carolina Department of Transportation (NCDOT) hereby gives assurance that no person shall on the ground of race, color, national origin, sex, age, and disability, be excluded from participation in, be denied the benefits of, or be otherwise subjected to discrimination under any program or activity conducted by the recipient, as provided by Title VI of the Civil Rights Act of 1964, the Civil Rights Restoration Act of 1987, and any other related Civil Rights authorities, whether those programs and activities are federally funded or not.

### *Obligation*

During the performance of this contract, the Contractor and its subcontractors are responsible for complying with NCDOT's Title VI Program. The Contractor must ensure that NCDOT's Notice of Nondiscrimination is posted in conspicuous locations accessible to all employees and subcontractors on the jobsite, along with the Contractor's own Equal Employment Opportunity (EEO) Policy Statement. The Contractor shall physically incorporate this "**TITLE VI AND NONDISCRIMINATION**" language, in its entirety, into all its subcontracts on federally-assisted and state-funded NCDOT-owned projects, and ensure its inclusion by subcontractors into all subsequent lower tier subcontracts. The Contractor and its subcontractors shall also physically incorporate the **FHWA-1273**, in its entirety, into all subcontracts and subsequent lower tier subcontracts on Federal-aid highway construction contracts only. The Contractor is

also responsible for making its subcontractors aware of NCDOT's Discrimination Complaints Process, as follows:

### FILING OF COMPLAINTS

1. **Applicability** – These complaint procedures apply to the beneficiaries of the NCDOT's programs, activities, and services, including, but not limited to, members of the public, contractors, subcontractors, consultants, and other sub-recipients of federal and state funds.
2. **Eligibility** – Any person or class of persons who believes he/she has been subjected to discrimination or retaliation prohibited by any of the Civil Rights authorities, based upon race, color, sex, age, national origin, or disability, may file a written complaint with NCDOT's Civil Rights office. The law prohibits intimidation or retaliation of any sort. The complaint may be filed by the affected individual or a representative, and must be in writing.
3. **Time Limits and Filing Options** – A complaint must be filed no later than 180 calendar days after the following:
  - The date of the alleged act of discrimination; or
  - The date when the person(s) became aware of the alleged discrimination; or
  - Where there has been a continuing course of conduct, the date on which that conduct was discontinued or the latest instance of the conduct.

Title VI and other discrimination complaints may be submitted to the following entities:

- **North Carolina Department of Transportation**, Office of Equal Opportunity & Workforce Services (EOWS), External Civil Rights Section, 1511 Mail Service Center, Raleigh, NC 27699-1511; 919-508-1808 or toll free 800-522-0453
- **US Department of Transportation**, Departmental Office of Civil Rights, External Civil Rights Programs Division, 1200 New Jersey Avenue, SE, Washington, DC 20590; 202-366-4070
  - Federal Highway Administration**, North Carolina Division Office, 310 New Bern Avenue, Suite 410, Raleigh, NC 27601, 919-747-7010
  - Federal Highway Administration**, Office of Civil Rights, 1200 New Jersey Avenue, SE, 8<sup>th</sup> Floor, E81-314, Washington, DC 20590, 202-366-0693 / 366-0752
  - Federal Transit Administration**, Office of Civil Rights, ATTN: Title VI Program Coordinator, East Bldg. 5<sup>th</sup> Floor – TCR, 1200 New Jersey Avenue, SE, Washington, DC 20590
  - Federal Aviation Administration**, Office of Civil Rights, 800 Independence Avenue, SW, Washington, DC 20591, 202-267-3258
- **US Department of Justice**, Special Litigation Section, Civil Rights Division, 950 Pennsylvania Avenue, NW, Washington, DC 20530, 202-514-6255 or toll free 877-218-5228

4. **Format for Complaints** – Complaints must be in **writing** and **signed** by the complainant(s) or a representative and include the complainant's name, address, and telephone number. Complaints received by fax or e-mail will be acknowledged and processed. Allegations received by telephone will be reduced to writing and provided to the complainant for confirmation or revision before processing. Complaints will be accepted in other languages including Braille.

5. **Discrimination Complaint Form** – Contact NCDOT EOWS at the phone number above to receive a full copy of the Discrimination Complaint Form and procedures.
6. **Complaint Basis** – Allegations must be based on issues involving race, color, national origin, sex, age, or disability. The term “basis” refers to the complainant’s membership in a protected group category. Contact this office to receive a Discrimination Complaint Form.

Protected Categories	Definition	Examples	Applicable Statutes and Regulations	
			FHWA	FTA
Race	An individual belonging to one of the accepted racial groups; or the perception, based usually on physical characteristics that a person is a member of a racial group	Black/African American, Hispanic/Latino, Asian, American Indian/Alaska Native, Native Hawaiian/Pacific Islander, White	Title VI of the Civil Rights Act of 1964; 49 CFR Part 21; 23 CFR 200	Title VI of the Civil Rights Act of 1964; 49 CFR Part 21; Circular 4702.1B
Color	Color of skin, including shade of skin within a racial group	Black, White, brown, yellow, etc.		
National Origin	Place of birth. Citizenship is not a factor. Discrimination based on language or a person’s accent is also covered.	Mexican, Cuban, Japanese, Vietnamese, Chinese		
Sex	Gender	Women and Men	1973 Federal-Aid Highway Act	Title IX of the Education Amendments of 1972
Age	Persons of any age	21 year old person	Age Discrimination Act of 1975	
Disability	Physical or mental impairment, permanent or temporary, or perceived.	Blind, alcoholic, paraplegic, epileptic, diabetic, arthritic	Section 504 of the Rehabilitation Act of 1973; Americans with Disabilities Act of 1990	

### **III. Pertinent Nondiscrimination Authorities**

During the performance of this contract, the contractor, for itself, its assignees, and successors in interest agrees to comply with the following non-discrimination statutes and authorities, including, but not limited to:

- Title VI of the Civil Rights Act of 1964 (42 U.S.C. § 2000d *et seq.*, 78 stat. 252), (prohibits discrimination on the basis of race, color, national origin); and 49 CFR Part 21.
- The Uniform Relocation Assistance and Real Property Acquisition Policies Act of 1970, (42 U.S.C. § 4601), (prohibits unfair treatment of persons displaced or whose property has been acquired because of Federal or Federal-aid programs and projects);
- Federal-Aid Highway Act of 1973, (23 U.S.C. § 324 *et seq.*), (prohibits discrimination on the basis of sex);

- Section 504 of the Rehabilitation Act of 1973, (29 U.S.C. § 794 *et seq.*), as amended, (prohibits discrimination on the basis of disability); and 49 CFR Part 27;
- The Age Discrimination Act of 1975, as amended, (42 U.S.C. § 6101 *et seq.*), (prohibits discrimination on the basis of age);
- Airport and Airway Improvement Act of 1982, (49 USC § 471, Section 47123), as amended, (prohibits discrimination based on race, creed, color, national origin, or sex);
- The Civil Rights Restoration Act of 1987, (PL 100-209), (Broadened the scope, coverage and applicability of Title VI of the Civil Rights Act of 1964, The Age Discrimination Act of 1975 and Section 504 of the Rehabilitation Act of 1973, by expanding the definition of the terms “programs or activities” to include all of the programs or activities of the Federal-aid recipients, sub-recipients and contractors, whether such programs or activities are Federally funded or not);
- Titles II and III of the Americans with Disabilities Act, which prohibit discrimination on the basis of disability in the operation of public entities, public and private transportation systems, places of public accommodation, and certain testing entities (42 U.S.C. §§ 12131 – 12189) as implemented by Department of Transportation regulations at 49 C.F.R. parts 37 and 38;
- The Federal Aviation Administration’s Non-discrimination statute (49 U.S.C. § 47123) (prohibits discrimination on the basis of race, color, national origin, and sex);
- Executive Order 12898, Federal Actions to Address Environmental Justice in Minority Populations and Low-Income Populations, which ensures discrimination against minority populations by discouraging programs, policies, and activities with disproportionately high and adverse human health or environmental effects on minority and low-income populations;
- Executive Order 13166, Improving Access to Services for Persons with Limited English Proficiency, and resulting agency guidance, national origin discrimination includes discrimination because of limited English proficiency (LEP). To ensure compliance with Title VI, you must take reasonable steps to ensure that LEP persons have meaningful access to your programs (70 Fed. Reg. at 74087 to 74100);
- Title IX of the Education Amendments of 1972, as amended, which prohibits you from discriminating because of sex in education programs or activities (20 U.S.C. 1681 *et seq.*).
- Title VII of the Civil Rights Act of 1964 (42 U.S.C. § 2000e *et seq.*, Pub. L. 88-352), (prohibits employment discrimination on the basis of race, color, religion, sex, or national origin);
- 49 CFR Part 26, regulation to ensure nondiscrimination in the award and administration of DOT-assisted contracts in the Department's highway, transit, and airport financial assistance programs, as regards the use of Disadvantaged Business Enterprises (DBEs);
- Form FHWA-1273, “Required Contract Provisions,” a collection of contract provisions and proposal notices that are generally applicable to *all Federal-aid construction projects* and must be made a part of, and physically incorporated into, *all federally-assisted contracts*, as well as appropriate subcontracts and purchase orders, particularly Sections II (Nondiscrimination) and III (Nonsegregated Facilities).

**STANDARD SPECIAL PROVISION****ON-THE-JOB TRAINING**

(10-16-07) (Rev. 4-21-15)

Z-10

**Description**

The North Carolina Department of Transportation will administer a custom version of the Federal On-the-Job Training (OJT) Program, commonly referred to as the Alternate OJT Program. All contractors (existing and newcomers) will be automatically placed in the Alternate Program. Standard OJT requirements typically associated with individual projects will no longer be applied at the project level. Instead, these requirements will be applicable on an annual basis for each contractor administered by the OJT Program Manager.

On the Job Training shall meet the requirements of 23 CFR 230.107 (b), 23 USC – Section 140, this provision and the On-the-Job Training Program Manual.

The Alternate OJT Program will allow a contractor to train employees on Federal, State and privately funded projects located in North Carolina. However, priority shall be given to training employees on NCDOT Federal-Aid funded projects.

**Minorities and Women**

Developing, training and upgrading of minorities and women toward journeyman level status is a primary objective of this special training provision. Accordingly, the Contractor shall make every effort to enroll minority and women as trainees to the extent that such persons are available within a reasonable area of recruitment. This training commitment is not intended, and shall not be used, to discriminate against any applicant for training, whether a member of a minority group or not.

**Assigning Training Goals**

The Department, through the OJT Program Manager, will assign training goals for a calendar year based on the contractors' past three years' activity and the contractors' anticipated upcoming year's activity with the Department. At the beginning of each year, all contractors eligible will be contacted by the Department to determine the number of trainees that will be assigned for the upcoming calendar year. At that time the Contractor shall enter into an agreement with the Department to provide a self-imposed on-the-job training program for the calendar year. This agreement will include a specific number of annual training goals agreed to by both parties. The number of training assignments may range from 1 to 15 per contractor per calendar year. The Contractor shall sign an agreement to fulfill their annual goal for the year.\

### Training Classifications

The Contractor shall provide on-the-job training aimed at developing full journeyman level workers in the construction craft/operator positions. Preference shall be given to providing training in the following skilled work classifications:

Equipment Operators	Office Engineers
Truck Drivers	Estimators
Carpenters	Iron / Reinforcing Steel Workers
Concrete Finishers	Mechanics
Pipe Layers	Welders

The Department has established common training classifications and their respective training requirements that may be used by the contractors. However, the classifications established are not all-inclusive. Where the training is oriented toward construction applications, training will be allowed in lower-level management positions such as office engineers and estimators. Contractors shall submit new classifications for specific job functions that their employees are performing. The Department will review and recommend for acceptance to FHWA the new classifications proposed by contractors, if applicable. New classifications shall meet the following requirements:

Proposed training classifications are reasonable and realistic based on the job skill classification needs, and

The number of training hours specified in the training classification is consistent with common practices and provides enough time for the trainee to obtain journeyman level status.

The Contractor may allow trainees to be trained by a subcontractor provided that the Contractor retains primary responsibility for meeting the training and this provision is made applicable to the subcontract. However, only the Contractor will receive credit towards the annual goal for the trainee.

Where feasible, 25 percent of apprentices or trainees in each occupation shall be in their first year of apprenticeship or training. The number of trainees shall be distributed among the work classifications on the basis of the contractor's needs and the availability of journeymen in the various classifications within a reasonable area of recruitment.

No employee shall be employed as a trainee in any classification in which they have successfully completed a training course leading to journeyman level status or in which they have been employed as a journeyman.

**Records and Reports**

The Contractor shall maintain enrollment, monthly and completion reports documenting company compliance under these contract documents. These documents and any other information as requested shall be submitted to the OJT Program Manager.

Upon completion and graduation of the program, the Contractor shall provide each trainee with a certification Certificate showing the type and length of training satisfactorily completed.

**Trainee Interviews**

All trainees enrolled in the program will receive an initial and Trainee/Post graduate interview conducted by the OJT program staff.

**Trainee Wages**

Contractors shall compensate trainees on a graduating pay scale based upon a percentage of the prevailing minimum journeyman wages (Davis-Bacon Act). Minimum pay shall be as follows:

60 percent	of the journeyman wage for the first half of the training period
75 percent	of the journeyman wage for the third quarter of the training period
90 percent	of the journeyman wage for the last quarter of the training period

In no instance shall a trainee be paid less than the local minimum wage. The Contractor shall adhere to the minimum hourly wage rate that will satisfy both the NC Department of Labor (NCDOL) and the Department.

**Achieving or Failing to Meet Training Goals**

The Contractor will be credited for each trainee employed by him on the contract work who is currently enrolled or becomes enrolled in an approved program and who receives training for at least 50 percent of the specific program requirement. Trainees will be allowed to be transferred between projects if required by the Contractor's scheduled workload to meet training goals.

If a contractor fails to attain their training assignments for the calendar year, they may be taken off the NCDOT's Bidders List.

**Measurement and Payment**

No compensation will be made for providing required training in accordance with these contract documents.



**STANDARD SPECIAL PROVISION**

**NAME CHANGE FOR NCDENR**

(1-19-16)

Z-11

**Description**

Wherever in the 2012 Standard Specifications, Project Special Provisions, Standard Special Provisions, Permits or Plans that reference is made to “NCDENR” or “North Carolina Department of Environment and Natural Resources”, replace with “NCDEQ” or “North Carolina Department of Environmental Quality” respectively, as the case may be.

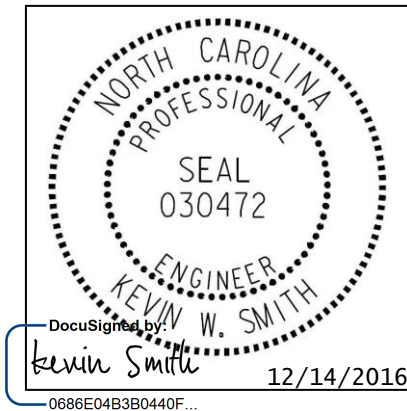

**U-5742**  
**INTELLIGENT TRANSPORTATION SYSTEMS**  
**TRAFFIC SIGNAL SYSTEM**  
**UPGRADE AND EXPANSION**

**PROJECT SPECIAL PROVISIONS**

Not Valid Unless Signed

**Contents**

**1. GENERAL REQUIREMENTS..... 10**

1.1. DESCRIPTION..... 10

    A. *General*..... 10

    B. *Scope* ..... 10

1.2. MATERIAL..... 10

    A. *General*..... 10

    B. *Submittal Requirements*..... 11

    C. *Observation Period* ..... 11

    D. *Plan of Record Documentation* ..... 11

    E. *Performance of Warranty Repair and Maintenance* ..... 11

1.3. CONSTRUCTION METHODS ..... 12

    A. *General*..... 12

    B. *Removal of Existing Equipment and Material* ..... 12

    C. *Requirements for Historic Areas* ..... 12

    D. *Related Projects* ..... 13

    E. *Sequence of Construction*..... 13

1.4. REQUIREMENTS FOR CABLES CROSSING RAILROADS ..... 16

    A. *Railroad Crossings*..... 16

    B. *Requirements for Insurance* ..... 17

    C. *Delays Caused By Operations of Others*..... 18

    D. *Cooperation with Others*..... 18

    E. *Authority of Railroad Engineer*..... 18

    F. *Interference with Railroad Operations* ..... 18

    G. *Storage of Materials*..... 18

    H. *Flagging Protection or Watchman Service* ..... 19

    I. *Completion and Acceptance of Work*..... 19

1.5. MEASUREMENT AND PAYMENT ..... 19

**2. TEMPORARY TRAFFIC CONTROL ..... 20**

2.1. DESCRIPTION..... 20

2.2.	GENERAL REQUIREMENTS.....	20
A.	<i>Maintenance of Traffic</i> .....	20
B.	<i>Temporary Lane Closures</i> .....	20
C.	<i>Traffic Stoppage</i> .....	21
D.	<i>Traffic Control Supervision</i> .....	21
E.	<i>Vehicular Access</i> .....	21
F.	<i>Pedestrian Access</i> .....	21
2.3.	MATERIALS.....	22
A.	<i>Work Zone Traffic Control Devices</i> .....	22
B.	<i>Work Zone Signs</i> .....	22
C.	<i>Flashing Arrow Boards</i> .....	22
D.	<i>Portable Changeable Message Signs</i> .....	23
E.	<i>Drums</i> .....	23
F.	<i>Cones</i> .....	23
G.	<i>Barricades</i> .....	23
H.	<i>Flaggers</i> .....	23
I.	<i>Truck Mounted Attenuators</i> .....	23
J.	<i>Skinny Drums</i> .....	24
2.4.	CONSTRUCTION METHODS.....	24
A.	<i>Work Zone Traffic Control Devices</i> .....	24
B.	<i>Work Zone Signs</i> .....	24
C.	<i>Flashing Arrow Boards</i> .....	24
D.	<i>Portable Changeable Message Signs</i> .....	25
E.	<i>Drums</i> .....	25
F.	<i>Cones</i> .....	26
G.	<i>Barricades</i> .....	26
H.	<i>Flaggers</i> .....	26
I.	<i>Truck Mounted Attenuator</i> .....	27
J.	<i>Skinny Drums</i> .....	27
K.	<i>Pedestrian Safety</i> .....	27
2.5.	MAINTENANCE AND INSPECTION.....	28
2.6.	FAILURE TO MAINTAIN TRAFFIC CONTROL.....	28
2.7.	MEASUREMENT AND PAYMENT.....	28
<b>3.</b>	<b>LAW ENFORCEMENT.....</b>	<b>31</b>
3.1.	DESCRIPTION.....	31
3.2.	CONSTRUCTION METHODS.....	31
3.3.	MEASUREMENT AND PAYMENT.....	31
<b>4.</b>	<b>SIGNAL HEADS.....</b>	<b>32</b>
4.1.	DESCRIPTION.....	32
4.2.	MATERIAL.....	32
A.	<i>General:</i> .....	32
B.	<i>Vehicle Signal Heads:</i> .....	34
C.	<i>Signal Cable:</i> .....	37
4.3.	CONSTRUCTION METHODS.....	37
4.4.	MEASUREMENT AND PAYMENT.....	37

<b>5. MESSENGER CABLE.....</b>	<b>39</b>
5.1. DESCRIPTION.....	39
5.2. MATERIAL.....	39
5.3. CONSTRUCTION METHODS.....	39
5.4. MEASUREMENT AND PAYMENT.....	39
<b>6. UNDERGROUND CABLE INSTALLATION.....</b>	<b>40</b>
6.1. DESCRIPTION.....	40
6.2. MATERIAL.....	40
6.3. CONSTRUCTION METHODS.....	40
6.4. MEASUREMENT AND PAYMENT.....	40
<b>7. JUNCTION BOXES.....</b>	<b>42</b>
7.1. DESCRIPTION.....	42
7.2. MATERIAL.....	42
7.3. CONSTRUCTION METHODS.....	42
7.4. MEASUREMENT AND PAYMENT.....	42
<b>8. WOOD POLES.....</b>	<b>43</b>
8.1. DESCRIPTION.....	43
8.2. MATERIAL.....	43
A. <i>General</i> .....	43
B. <i>Wood Pole</i> .....	43
C. <i>CCTV Wood Pole</i> .....	43
D. <i>Replace Existing Wood Pole</i> .....	43
8.3. CONSTRUCTION METHOD.....	43
8.4. MEASUREMENT AND PAYMENT.....	43
<b>9. GUY ASSEMBLIES.....</b>	<b>45</b>
9.1. DESCRIPTION.....	45
9.2. MATERIAL.....	45
9.3. CONSTRUCTION METHODS.....	45
9.4. MEASUREMENT AND PAYMENT.....	45
<b>10. RISER ASSEMBLIES.....</b>	<b>46</b>
10.1. DESCRIPTION.....	46
10.2. MATERIAL.....	46
10.3. CONSTRUCTION METHOD.....	46
10.4. MEASUREMENT AND PAYMENT.....	46
<b>11. INDUCTIVE DETECTION LOOPS.....</b>	<b>47</b>
11.1. DESCRIPTION.....	47
11.2. MATERIAL.....	47
11.3. CONSTRUCTION METHOD.....	47
11.4. MEASUREMENT AND PAYMENT.....	47
<b>12. LEAD-IN CABLE.....</b>	<b>48</b>
12.1. DESCRIPTION.....	48
12.2. MATERIAL.....	48

12.3. CONSTRUCTION METHOD .....	48
12.4. MEASUREMENT AND PAYMENT .....	48
<b>13. FIBER OPTIC CABLE .....</b>	<b>49</b>
13.1. DESCRIPTION .....	49
13.2. MATERIAL .....	49
13.3. CONSTRUCTION METHODS .....	49
13.4. MEASUREMENT AND PAYMENT .....	49
<b>14. FIBER OPTIC SPLICE CENTERS .....</b>	<b>51</b>
14.1. DESCRIPTION .....	51
14.2. MATERIALS .....	51
14.3. CONSTRUCTION METHODS .....	51
A. <i>General</i> .....	51
B. <i>Testing</i> .....	51
14.4. MEASUREMENT AND PAYMENT .....	52
<b>15. SPLICE CABINET (FIBER OPTICS) .....</b>	<b>53</b>
15.1. DESCRIPTION .....	53
15.2. MATERIAL .....	53
15.3. CONSTRUCTION METHODS .....	53
15.4. MEASUREMENT AND PAYMENT .....	53
<b>16. DELINEATOR MARKERS .....</b>	<b>54</b>
16.1. DESCRIPTION .....	54
16.2. MATERIALS .....	54
16.3. CONSTRUCTION METHODS .....	54
16.4. MEASUREMENT AND PAYMENT .....	54
<b>17. ETHERNET CABLE.....</b>	<b>55</b>
17.1. DESCRIPTION .....	55
17.2. MATERIAL .....	55
17.3. CONSTRUCTION METHODS .....	56
17.4. MEASUREMENT AND PAYMENT .....	56
<b>18. REMOVE EXISTING COMMUNICATIONS CABLE.....</b>	<b>57</b>
18.1. DESCRIPTION .....	57
18.2. CONSTRUCTION METHODS .....	57
18.3. MEASUREMENT AND PAYMENT .....	57
<b>19. BACK PULL FIBER OPTIC CABLE.....</b>	<b>58</b>
19.1. DESCRIPTION .....	58
19.2. CONSTRUCTION METHODS .....	58
19.3. MEASUREMENT AND PAYMENT .....	58
<b>20. CABLE TRANSFERS .....</b>	<b>59</b>
20.1. DESCRIPTION .....	59
20.2. CONSTRUCTION METHODS .....	59
20.3. MEASUREMENT AND PAYMENT .....	59

<b>21. WIRELESS ETHERNET RADIO SYSTEM.....</b>	<b>60</b>
21.1. DESCRIPTION.....	60
21.2. MATERIALS .....	60
A. <i>Field Set-up Software</i> .....	60
B. <i>Central Management Software</i> .....	60
C. <i>2.4 GHz Broadband (Ethernet) Radio</i> .....	61
D. <i>2.4 GHz Broadband (Ethernet) Dual Radio (Integrated Panel)</i> .....	63
E. <i>2.4 GHz Panel (Standalone) Antenna – (20 dBi Gain)</i> .....	63
F. <i>5.8 GHz Broadband (Ethernet) Radio</i> .....	63
G. <i>5.8 GHz Broadband (Ethernet) Dual Radio (Integrated Panel)</i> .....	66
H. <i>5.8 GHz Panel (Standalone) Antenna – (23 dBi Gain)</i> .....	66
I. <i>Antenna Mounting Hardware Kit</i> .....	66
21.3. CONSTRUCTION METHODS .....	67
A. <i>General</i> .....	67
21.4. MEASUREMENT AND PAYMENT .....	67
<b>22. SIGNAL CABINET FOUNDATIONS .....</b>	<b>69</b>
22.1. DESCRIPTION.....	69
22.2. MATERIAL .....	69
22.3. CONSTRUCTION METHODS .....	69
22.4. MEASUREMENT AND PAYMENT .....	69
<b>23. CONTROLLERS WITH CABINETS.....</b>	<b>70</b>
23.1. DESCRIPTION.....	70
23.2. MATERIAL .....	70
A. <i>General</i> .....	70
B. <i>Type 2070E Controllers</i> .....	70
C. <i>General Cabinets</i> .....	70
D. <i>Type 170E Cabinets</i> .....	71
E. <i>Type 170 Detector Sensor Units</i> .....	94
23.3. CONSTRUCTION METHODS .....	94
A. <i>General</i> .....	94
B. <i>Workshop</i> .....	94
C. <i>Railroad Preemption</i> .....	95
D. <i>Vehicle Preemption</i> .....	95
E. <i>Vehicle Detection</i> .....	95
F. <i>Audible Pedestrian Signals</i> .....	95
G. <i>Red Light Cameras</i> .....	95
23.4. MEASUREMENT AND PAYMENT .....	95
<b>24. MODIFY CABINET FOUNDATIONS .....</b>	<b>97</b>
24.1. DESCRIPTION.....	97
24.2. MATERIAL .....	97
24.3. CONSTRUCTION METHODS .....	97
24.4. MEASUREMENT AND PAYMENT .....	97
<b>25. CABINET BASE ADAPTER/EXTENDER .....</b>	<b>98</b>
25.1. DESCRIPTION.....	98

25.2. MATERIAL .....	98
25.3. CONSTRUCTION METHODS .....	98
25.4. MEASUREMENT AND PAYMENT .....	98
<b>26. ELECTRICAL SERVICE .....</b>	<b>99</b>
26.1. DESCRIPTION .....	99
26.2. MATERIAL .....	99
A. <i>Meter Base/Disconnect Combination Panel</i> .....	99
B. <i>Equipment Cabinet Disconnect</i> .....	100
C. <i>3-Wire Copper Service Entrance Conductors</i> .....	100
D. <i>3-Wire Copper Feeder Conductors</i> .....	100
E. <i>Grounding System</i> .....	101
26.3. CONSTRUCTION METHODS .....	101
A. <i>General</i> .....	101
B. <i>Meter Base/Disconnect Combination Panel</i> .....	101
C. <i>Electrical Service Disconnect</i> .....	101
D. <i>3-Wire Copper Service Entrance Conductors</i> .....	101
E. <i>3-Wire Copper Feeder Conductors</i> .....	101
F. <i>Grounding System</i> .....	101
26.4. MEASUREMENT AND PAYMENT .....	102
<b>27. DIGITAL CCTV EQUIPMENT .....</b>	<b>103</b>
27.1. DESCRIPTION .....	103
27.2. MATERIAL .....	103
A. <i>General</i> .....	103
B. <i>Camera and Lens</i> .....	103
C. <i>Camera Housing</i> .....	104
D. <i>Pan and Tilt Unit</i> .....	104
E. <i>Control Receiver/Driver</i> .....	105
F. <i>Electrical</i> .....	105
G. <i>CCTV Camera Attachment to Pole</i> .....	105
H. <i>Surge Suppression</i> .....	105
27.3. CONSTRUCTION METHODS .....	106
A. <i>General</i> .....	106
B. <i>Electrical and Mechanical Requirements</i> .....	106
27.4. MEASUREMENT AND PAYMENT .....	106
<b>28. FIELD EQUIPMENT CABINET .....</b>	<b>107</b>
28.1. DESCRIPTION .....	107
28.2. MATERIAL .....	107
A. <i>Shelf Drawer</i> .....	107
B. <i>Cabinet Light</i> .....	107
C. <i>Surge Protection for System Equipment</i> .....	108
D. <i>Technician Pad</i> .....	109
28.3. CONSTRUCTION METHODS .....	109
28.4. MEASUREMENT AND PAYMENT .....	109
<b>29. REMOVE EXISTING WIRELESS RADIOS.....</b>	<b>110</b>

29.1. DESCRIPTION .....	110
29.2. CONSTRUCTION METHODS .....	110
29.3. MEASUREMENT AND PAYMENT .....	110
<b>30. REMOVE EXISTING CCTV ASSEMBLY.....</b>	<b>111</b>
30.1. DESCRIPTION .....	111
30.2. CONSTRUCTION METHODS .....	111
A. <i>Remove Existing CCTV Assembly</i> .....	111
B. <i>Remove Existing Cabinet</i> .....	111
C. <i>Remove Existing Foundation</i> .....	111
30.3. MEASUREMENT AND PAYMENT .....	112
<b>31. LOCAL AREA NETWORK EQUIPMENT .....</b>	<b>113</b>
31.1. DESCRIPTION .....	113
31.2. MATERIAL .....	113
A. <i>General</i> .....	113
B. <i>Network Performance Management Software</i> .....	113
C. <i>Field Ethernet Switch</i> .....	114
D. <i>Core Ethernet Switch</i> .....	116
E. <i>Network Ethernet Switch</i> .....	119
F. <i>Cable</i> .....	119
31.3. CONSTRUCTION METHODS .....	119
A. <i>General</i> .....	119
B. <i>Requirements Definition Document</i> .....	120
C. <i>LAN Integration</i> .....	120
D. <i>Network Performance Management Software</i> .....	120
E. <i>Field Ethernet Switch</i> .....	120
F. <i>Core Ethernet Switch</i> .....	121
G. <i>Network Ethernet Switch</i> .....	121
31.4. MEASUREMENT AND PAYMENT .....	121
<b>32. SYSTEM SOFTWARE .....</b>	<b>123</b>
32.1. DESCRIPTION .....	123
32.2. MATERIAL .....	123
A. <i>General</i> .....	123
B. <i>Distributed Processing System Software</i> .....	123
C. <i>CCTV Control Software</i> .....	124
32.3. CONSTRUCTION METHODS .....	125
A. <i>General</i> .....	125
B. <i>Local Controller Software</i> .....	125
C. <i>Distributed Processing System Software</i> .....	125
D. <i>CCTV Control Software</i> .....	125
32.4. MEASUREMENT AND PAYMENT .....	126
<b>33. COMPUTER HARDWARE .....</b>	<b>127</b>
33.1. DESCRIPTION .....	127
33.2. MATERIAL .....	127
A. <i>General</i> .....	127



- B. *Distributed Processing Signal System Server* ..... 127
- C. *Distributed Processing Signal System Communications Server* ..... 128
- D. *CCTV Video Server* ..... 128
- E. *Remote Access Server*..... 129
- F. *Backup Storage Server* ..... 129
- G. *Keyboard Video Mouse Switch*..... 130
- H. *Computer Workstations*..... 130
- I. *Surge Suppression Strips*..... 131
- J. *Equipment Rack Cabinet* ..... 131
- K. *Uninterruptible Power Supply*..... 131
- 33.3. CONSTRUCTION METHODS ..... 132
  - A. *General*..... 132
  - B. *Distributed Processing Signal Server* ..... 132
  - C. *Signal System Communications Server* ..... 132
  - D. *CCTV Video Server* ..... 132
  - E. *Remote Access Server*..... 133
  - F. *Backup Storage Server* ..... 133
  - G. *Keyboard Video Mouse Switch*..... 133
  - H. *Computer Workstations*..... 133
  - I. *Surge Suppression Strips*..... 133
  - J. *Rack Cabinets*..... 133
  - K. *Uninterruptible Power Supply*..... 134
  - L. *Computer Hardware Integration*..... 134
- 33.4. MEASUREMENT AND PAYMENT ..... 134
- 34. CENTRAL VIDEO SYSTEM ..... 136**
  - 34.1. DESCRIPTION ..... 136
  - 34.2. MATERIAL ..... 136
    - A. *General*..... 136
    - B. *Video Wall System* ..... 136
    - C. *LCD Video Monitors* ..... 138
  - 34.3. CONSTRUCTION METHODS ..... 139
    - A. *General*..... 139
    - B. *Video Wall System*..... 139
    - C. *LCD Video Monitor*..... 140
  - 34.4. MEASUREMENT AND PAYMENT ..... 140
- 35. SYSTEM SUPPORT EQUIPMENT ..... 141**
  - 35.1. DESCRIPTION ..... 141
  - 35.2. MATERIAL ..... 141
    - A. *Signal System Support Equipment*..... 141
    - B. *Communication System Support Equipment* ..... 142
    - C. *CCTV System Support Equipment*..... 142
  - 35.3. MEASUREMENT AND PAYMENT ..... 142
- 36. TRAINING ..... 145**
  - 36.1. DESCRIPTION ..... 145
  - 36.2. MATERIAL ..... 145

A. *General*..... 145  
B. *Subject Areas*..... 146  
C. *Required Content and Format*..... 146  
36.3. MEASUREMENT AND PAYMENT ..... 150  
**37. TESTING AND ACCEPTANCE ..... 151**  
37.1. DESCRIPTION ..... 151  
37.2. CABLE TESTS ..... 151  
37.3. EQUIPMENT TESTS ..... 151  
37.4. TRAFFIC SIGNAL SUBSYSTEM..... 151  
37.5. INTERSECTION OPERATIONAL TESTS ..... 151  
37.6. SYSTEM OPERATIONAL TEST ..... 151  
37.7. OBSERVATION PERIOD..... 153  
37.8. FINAL ACCEPTANCE ..... 153  
37.9. MEASUREMENT AND PAYMENT ..... 154

## 1. GENERAL REQUIREMENTS

### 1.1.DESCRPTION

#### A. General

Conform to these Project Special Provisions, Project Plans, the Signals and ITS Project Special Provisions (current version 12.5), and the *2012 Standard Specifications for Roads and Structures* (also referred to hereinafter as the “Standard Specifications”). The current edition of these specifications and publications in effect on the date of advertisement will apply.

In the event of a conflict between these Project Special Provisions and the Standard Specifications or the Signals and ITS Project Special Provisions, these Project Special Provisions govern.

In the event of a conflict between the Signals and ITS Project Special Provisions and the Standard Specifications, the Signals and ITS Project Special Provisions govern.

#### B. Scope

Furnish, install, and fully integrate new and existing traffic signal controllers and cabinets, new and existing fiber optic communications cable, new and existing wireless radio communications links, new and existing closed-circuit television camera units, and new and existing central hardware and software for the upgrade and expansion of the existing central distributed processing traffic signal system for the City of Fayetteville in North Carolina.

Furnish, install, and fully integrate approximately 300 new 2070E traffic signal controllers in new model 332 and 336 style cabinets to replace existing controllers and cabinets at locations shown in the Plans.

Furnish, install, and fully integrate approximately 50 new digital IP closed circuit television (CCTV) cameras. Establish new installations or replace existing analog CCTV cameras at locations shown in the Plans.

Furnish and install approximately 21 miles of new fiber optic cables in new underground conduit or attached to existing joint-use utility poles as shown in the Plans. Integrate new fiber optic communications with the existing signal system communications network as shown in the Plans.

Furnish, install, and fully integrate approximately 6 new wireless Ethernet radio systems to replace existing serial radio systems at locations shown in the Plans.

Furnish, install, and fully integrate a new head-end termination of the communications network and new signal system servers at the NCDOT Division 6 Traffic Engineering Office located at 450 Transportation Drive in Fayetteville.

Fully integrate the existing traffic operations center (TOC) in the City of Fayetteville Traffic Services Division located at 339 Alexander Street in Fayetteville.

### 1.2.MATERIAL

#### A. General

Comply with Section 1098-1 of the Standard Specifications in addition to the following special provisions.

**B. Submittal Requirements**

The Standard Specifications are revised as follows:

Page 10-208, replace paragraph on line 34 with the following:

Submit for approval catalog cuts and/or shop drawings for materials proposed for use on the project. Allow 40 days for review of each submittal. Do not fabricate or order material until receipt of Engineer's approval.

Submit 4 copies of each catalog cut and/or drawing and show for each component the material description, brand name, stock-number, size, rating, manufacturing specification and the intended use (identified by labeling all components with the corresponding contract line item number). Present the submittals neatly arranged in the same order as the contract bid items. Upon approval by the Engineer, electronic submittals of catalog cuts and drawings may be accepted in lieu of hard copies.

Electronic (PDF) copies of reviewed submittals will be returned to the Engineer from the ITS and Signals Unit.

**C. Observation Period**

Prior to final acceptance, all Contractor-furnished equipment and software shall successfully complete a 60-day Observation Period.

The 60-day Observation Period is considered to be part of the work included in the total contract time and must be completed prior to final acceptance of the project.

Final acceptance will occur following the successful completion of the 60-day Observation Period and after all documentation requirements have been fully satisfied.

Refer to the Testing and Acceptance section of these Project Special Provisions for additional requirements.

**D. Plan of Record Documentation**

Comply with Article 1098-1(F) of the Standard Specifications. Plan of record documentation will be subject to approval by the Engineer before final acceptance.

**E. Performance of Warranty Repair and Maintenance**

Provide authorization to the City of Fayetteville and the North Carolina Department of Transportation to perform all warranty repairs after project acceptance. The decision to perform warranty work at a City or Department facility by City or Department technicians or to have warranty work performed by the vendor shall be at the discretion of the City of Fayetteville or the North Carolina Department of Transportation. Provide any training required by the manufacturer to authorize the City of Fayetteville and the North Carolina Department of Transportation to perform warranty work and ensure manufacturer will furnish parts to the City of Fayetteville and the North Carolina Department of Transportation for all warranty repairs at no cost to the City or Department. In addition, ensure the manufacturer agrees to provide prompt technical support to the City of Fayetteville and the North Carolina Department of Transportation technicians for a period of one year after the end of the warranty period at no cost to the City or Department. Defective parts replaced under warranty by the City of Fayetteville and the North Carolina Department of Transportation will be returned to the vendor at the vendor's request. Provide schematics, part lists, and other documentation to perform bench repair to the City of Fayetteville or the North Carolina

Department of Transportation within 2 weeks upon request. The City and Department agree not to divulge any proprietary information in the schematics, part lists and other documentation upon request from the vendor. After project acceptance and at the request of the City or Department, manufacturer shall perform warranty repairs to equipment which fails during the warranty period at no cost to the City or Department including freight costs to ship repaired equipment back to Fayetteville. Ensure all equipment is repaired and returned to the City of Fayetteville or the North Carolina Department of Transportation within 21 calendar days of receipt by the manufacturer.

### **1.3.CONSTRUCTION METHODS**

#### **A. General**

Comply with Section 1700-3 of the Standard Specifications in addition to the following special provisions.

#### **B. Removal of Existing Equipment and Material**

Remove all Department-owned signals and communications related equipment and material that will not be used. Assume ownership of removed poles, messenger cable, interconnect cable, communications cable and supporting hardware. Return all other equipment and material between 8:00 a.m. and 12:00 p.m., Monday through Thursday, to the Division 6 Traffic Services Office located at 450 Transportation Drive in Fayetteville.

Remove all City of Fayetteville owned signals and communications related equipment and material that will not be used. Assume ownership of removed poles, messenger cable, interconnect cable, communications cable and supporting hardware. Return all other equipment and material between 8:00 a.m. and 12:00 p.m., Monday through Thursday, to the City Traffic Services Division located at 339 Alexander Street in Fayetteville.

#### **C. Requirements for Historic Areas**

As shown in the Plans, some work will be conducted within areas determined to contain properties with documented historic significance. If it is necessary to deviate from the Plans in these areas, alert the Engineer to contact Project Development And Environmental Analysis Branch-Historic Architecture Group of the North Carolina Department of Transportation for an effects determination before proceeding.

Avoid damaging or removing sidewalks and curbs within designated historic districts whenever possible. Do not damage, disturb, or remove any existing granite curbs. Where granite curbs conflict with the installation of underground conduit and cable, bore (drill) conduit underneath granite curb. Do not bore through granite curbs. Replace any granite curb damaged due to construction of this project at no cost to the Department.

Where removal and replacement of concrete sidewalk and concrete curb is unavoidable, replace them with concrete materials that match the finish, appearance, and color of the adjacent existing sidewalk as close as technically feasible as determined by the Engineer. Finishes may include, but are not limited to, water-washed, broom, and trowel. The dimensions and the profile (i.e. shape) of the new curbing shall match that of the adjacent existing curbing.

Where removal and replacement of sidewalk constructed of materials other than concrete is unavoidable, replace the sidewalk with in-kind materials that match the finish, appearance, and color of the adjacent existing sidewalk as close as technically feasible as determined by the Engineer. If the sidewalk is constructed of materials such as brick, stone, or pavers, carefully remove and

subsequently reinstall the bricks, stones, or pavers using methods approved by the Engineer. Take photographs and make sketches to record the pattern of the existing materials prior to removal. Replace any bricks, stones, or pavers damaged due to construction on this project with approved in-kind, matching materials.

Repair and replacement of existing sidewalk will be measured and paid for in accordance with the Signal Cabinet Foundations section of these Project Special Provisions.

Complete all repairs with in-kind materials to all sidewalks removed for construction and reopen the repaired and restored sidewalk to pedestrian traffic within five consecutive calendar days following initial removal. If the Contractor fails to repair and reopen a sidewalk in accordance with these Project Special provisions within the time frame specified, the Department reserves the right to make the necessary repairs, and all expenses incurred by the Department in making the repairs and restoring the sidewalk will be deducted from payment due the Contractor, plus \$500 liquidated damage per occasion, per day, or any portion thereof, until corrected.

Do not trim, remove, or damage tree limbs within historic districts. Hand-lashing of aerial cables to messenger cable may be required in some areas due to overhanging and protruding tree limbs along the cable route. When required, hand-lashing will be performed at no additional cost to the Department.

#### **D. Related Projects**

Current transportation projects within the project area that may impact traffic signal operations and communications include, but are not limited to, the Raeford Road Widening (NCDOT U-4405) and NC-295 ITS (X-0002F). Do not begin any work within those areas until those projects are completed. Coordinate with the Engineer on how to proceed if those projects have not been completed and construction in these areas is on the critical path of the project schedule.

The City and Department have general maintenance backlog work for public safety that will need to be continued throughout the duration of this project. Coordinate with Engineer for actions to be taken if any maintenance construction prohibits the availability of the traffic signal for construction.

#### **E. Sequence of Construction**

Perform construction of the project in the sequence called for in these Project Special Provisions. All work not performed in accord with the sequence of construction must be approved by the Engineer. Adherence to the sequence of construction must be reflected in the Contractor's project schedule and all updates to the project schedule. Construction shall have minimal disruption to the existing signal operations.

Splicing work shall be completed on a per-group basis and no splicing work shall be performed in another group until the current group is fully operational. Performing all splicing work detailed in the Plans at one time will result in multiple groups being offline and liquidated damages being assessed to the Contractor for failing to follow the Sequence of Construction as outlined in these Project Special Provisions.

As new intersections are installed but are not under monitoring and supervision of the central system, maintain existing signal coordination and common controller clock time. All clocks that are updated shall be updated from a single clock source. Review each intersection that has been installed but is not online on a weekly basis in the form of a field visit and review the controller clock for drift against the common time source. Reset clock to common time source if it has drifted.

Document the field visit and any actions taken in the cabinet's maintenance diary. Record time and date of each visit, activity performed, and person performing visit. Maintain records of clock maintenance activities in a single document and furnish to the Engineer for review upon request. Failure to visit each intersection that is not online to check and update clocks will result in a liquidated damage of \$1,500 per visit not performed.

For the Sequence of Construction, the Contractor shall perform the work per the following phasing.

**Phase 1** – This phase shall consist of preparing the communications head-end and includes:

- Installing the new 24-SMFO cable from the splice cabinets on Alexander Street in existing conduit into TOC server room.
- Performing splicing of all cables at the splice cabinets on Alexander Street.

**Phase 2** – This phase shall consist of preparing the signal system at the NCDOT Division 6 Office and includes:

- Installing the new rack cabinets at the NCDOT Division 6 Office.
- Installing the new fiber optic interconnect center in the rack cabinet and terminating the two 144-SMFO cables originating from the splice cabinets on Alexander Street.
- Installing the core Ethernet switch and application servers in the rack cabinets.
- Configuring and integrating the application servers to establish the central signal system that accommodates Ethernet communications.
- Configuring and integrating the City-procured CCTV video module within the signal system software.
- Installing the new computer workstation at the NCDOT Division 6 Office and installing the signal system client software.

**Phase 3** – This phase shall consist of preparing the communications head-end at the TOC and includes:

- Installing the new rack cabinets at the TOC.
- Installing the new fiber optic interconnect center in the rack cabinet and terminating the 24-SMFO cables originating from the splice cabinets on Alexander Street.
- Installing the network Ethernet switch in the rack cabinet.
- Integrating the network Ethernet switch with the core Ethernet switch at the NCDOT Division 6 Office.
- Installing the new computer workstations at the TOC and installing the signal system client software.

**Phase 4** – This phase shall consist of installing new infrastructure for the fiber optic communications and includes:

- Installing new messenger cable throughout the project area. Also, installing communications cable ID markers on messenger cable to identify and reserve fiber optic cable attachment locations on existing utility poles.

- Installing new junction boxes, underground conduit, and pole risers throughout the project area.

**Phase 5** – This phase shall consist of installing new fiber optic communications cables and equipment and includes:

- Installing new fiber optic cables throughout the project area by lashing to aerial messenger cable or pulling through underground conduit.
- Installing new fiber optic splice enclosures and performing splicing where new fiber optic cables connect. No splicing involving existing fiber optic cables shall be performed during this phase.

**Phase 6** – This phase shall consist of integrating the Ethernet groups and includes:

- Performing one session of the cabinet and controller training for City and Department technicians (as detailed in these Project Special Provisions) prior to installing any new cabinets and controllers in the field.
- Integrating groups (one group at a time) in this order:
  - **Phase 6A (Central Area)** – Channels 8, 14, 10, 9, 5, 4, 15, 17, 19, 18, 2, 20, 26
  - **Phase 6B (Northern Area)** – Channels 24, 3, 25, 1, 16
  - **Phase 6C (Southern Area)** – Channels 7, 11, 6, 12, 13, 21, 22, 23, 28, 27
- The Contractor shall complete all work for a given group and verify it is fully functional before starting work in a different group. After taking down an existing communication channel, the contractor must complete all construction for traffic signals in that channel in a time period no greater than two (2) days per traffic signal in that channel. Establish time-based coordination within the limits of the prior closed loop system and maintain controller clocks.
- Performing splicing within the extents of the group involving existing fiber optic cables. This may result in a temporary loss of communications to some existing CCTV cameras within the group.
- Verifying that all existing traffic signal communication channels are still fully functional at the TOC.
- Performing signal work (cabinet and controller replacement) for traffic signals within the group.
- Performing CCTV work (camera installation and replacement) for proposed and existing CCTV cameras within the group.
- Performing communications work (field Ethernet switch installation and wireless radio upgrade) within the group.
- Integrating the field Ethernet switches within the group with the fiber optic communications network, the core Ethernet switch at the Division 6 Office, and the network Ethernet switch at the TOC.
- Integrating the Ethernet group with the signal system software at the TOC and Division 6 Office to establish communications with the traffic signals.



- Integrating the Ethernet group with the CCTV video module of signal system software at the TOC and Division 6 Office to establish communications with the CCTV cameras along with viewing video and controlling PTZ functions.

**Phase 7** – This phase shall consist of testing and integrating the Ethernet groups along NC-295 and includes:

- Performing fiber optic tests to confirm a home-run path from each connection point (Ramsey Street, McArthur Road, Murchison Road, and Bragg Boulevard) to the Division 6 Office.
- Integrating the existing field Ethernet switches along NC-295 with the fiber optic communications network and the existing NCDOT network Ethernet switch at the Division 6 Office.
- Integrating the existing video management software at the Division 6 Office to view video and control PTZ functions for the CCTV cameras along NC-295.
- Integrating the existing dynamic message sign (DMS) control software at the Division 6 Office to operate the DMS units along NC-295.

**Phase 8** – This phase shall consist of testing and integrating the Ethernet group at Fort Bragg and includes:

- Performing fiber optic tests to confirm a home-run path from the connection point (Bragg Boulevard and Knox Road) to the Division 6 Office.
- Integrating the fiber optic communications network and the existing NCDOT network Ethernet switch at the Division 6 Office.

**Phase 9** – This phase shall consist of upgrading the central video system and includes:

- Replacing existing video monitors in the TOC with a new video wall. Install new computer hardware and/or software to manage the video wall.
- Integrating the video wall inputs and control functionality.
- Installing the new monitor at the Division 6 Office.

**Phase 10** – This phase shall consist of all testing and training required in these Project Special Provisions prior to System Acceptance.

#### **1.4.REQUIREMENTS FOR CABLES CROSSING RAILROADS**

Copies of all executed railroad agreements and related correspondence may be obtained from the Resident Engineer.

##### **A. Railroad Crossings**

Do not commence cable routings over or under railroad-owned facilities until notification and coordination with Engineer and the appropriate railroad company has occurred. As shown on the Plans, one affected railroad facility on this project is owned by CSX Transportation (CSXT), herein called the Railroad Company. Install fiber optic communications cable as shown on the Plans and comply with CSXT guidelines.

**B. Requirements for Insurance**

The Contractor will be required to provide coverage conforming to the requirements of the Federal-Aid Policy Guide outlined under 23 CFR 646A for all work to be performed on the Railroad rights(s) of way under the terms of the contract by carrying insurance of the following kinds:

**Contractor's General Liability and Railroad Protective Liability Insurance**

i. Furnish a certificate of general liability insurance and railroad protective liability insurance evidencing a combined single limit of a minimum of \$5,000,000.00 per occurrence of general liability insurance naming CSX Transportation as the certificate holder and as an additional insured on the insurance policy.

ii. If any part of the work is sublet, similar insurance and evidence thereof in the same amounts as required of the Prime Contractor, shall be provided by the subcontractor to cover his operations on railroad right of way. As an alternative, the Prime Contractor may provide for the subcontractor by means of separate and individual policies.

iii. Certificates shall make reference to the project, milepost and county. Certificate description and project designation to include the following information: Installation of fiber optic communications cable under tracks of CSX Transportation, Cumberland County (include Railroad Milepost) identified as NC Project U-5742.

Use the address below for the Certificates of Insurance holder:

CSX Transportation, Inc.  
Risk Management (C- 907)  
500 Water Street  
Jacksonville, FL 32202

iv. All policies and certificates shall contain a clause requiring that thirty (30) days written notice be given the Department of Transportation and the Railroad Company prior to cancellation or change. The notices shall make reference to the project, milepost and county.

**NOTICE TO:**

CSX Transportation, Inc.  
Risk Management (C- 907)  
500 Water Street  
Jacksonville, FL 32202

**COPY NOTICE TO: NCDOT Resident Engineer**

v. Carry all insurance herein specified until the final inspection and acceptance of the project, or that portion of the project within railroad right of way, by the Department of Transportation or, in the case of subcontractors, until the Contractor furnishes a letter to the Engineer stating that the subcontractor has completed his subcontracted work within railroad right of way to the satisfaction of the Contractor and the Contractor will accomplish any additional work necessary on railroad right

of way with his own forces. It is understood that the amounts specified are minimum amounts and that the Contractor may carry insurance in larger amounts if he so desires. As to "aggregate limits", if the insurer establishes loss reserves equal to or in excess of the aggregate limit specified in any of the required insurance policies, immediately notify the Department of Transportation and cease all operations until the aggregate limit is reinstated. If the insurer establishes loss reserves equal to or in excess of one/half of the aggregate limit, arrange to restore the aggregate limit to at least the minimum amount stated in these requirements. Any insurance policies and certificates taken out and furnished due to these requirements shall be approved by the Department of Transportation and the Railroad Company as to form and amount prior to beginning work on railroad right of way.

No extra allowance will be made for the insurance required hereunder. The entire cost shall be included in the unit contract bid price for other pay items.

vi. Furnish evidence of insurance as required above for review to the Engineer.

### **C. Delays Caused By Operations of Others**

Neither the Department of Transportation nor the Railroad Company assumes any responsibility for any work performed by others in connection with the construction of the project, and the Contractor shall have no claim whatsoever against the Department of Transportation, or the Railroad Company for any inconvenience, delay, or additional cost incurred by him on account of such operations by others.

### **D. Cooperation with Others**

Cooperate with others participating in the construction of the project to the end that all work may be carried on to the best advantage.

### **E. Authority of Railroad Engineer**

The authorized representative of the Railroad Company hereinafter referred to as the Railroad Engineer, shall have the final authority in all matters affecting the safe maintenance of railroad traffic of his company.

### **F. Interference with Railroad Operations**

Arrange and conduct work so that there will be no interference with railroad operations, including train, signal, telephone and telegraphic services, or damage to the property of the Railroad Company or to the poles, wire, and other facilities of tenants on the rights of way of the Railroad Company. Wherever work is liable to affect the operations or safety of trains, the method of doing such work shall first be submitted to the Railroad Engineer for approval, but such approval shall not relieve the Contractor from liability.

Should conditions arising from or in connection with the work, require that immediate and unusual provisions be made to protect train operations and property of the Railroad Company, it shall be a part of the required services by the Contractor to make such provisions and if, in the judgment of the Railroad Engineer such provisions is insufficient, the Railroad Engineer or the Department of Transportation, may at the expense of the Contractor, require or provide such provisions as may be deemed necessary.

### **G. Storage of Materials**

Materials and equipment shall not be stored where they will interfere with railroad operations, nor on the rights of way of the Railroad Company without first having obtained permission from the

Railroad Engineer, and such permission will be with the understanding that the Railroad Company will not be liable or damage to such material and equipment from any cause and that the Railroad Engineer may move or require the Contractor to move, at the Contractor's expense, such material and equipment.

#### **H. Flagging Protection or Watchman Service**

The Contractor shall give 2 weeks advance notice to the Railroad Company in order that flagging service can be arranged and provided. No work shall be undertaken until the flagman is at the job site. All costs associated with scheduling and compensating flagman are the responsibility of the Contractor and shall be at no cost to the Department.

#### **I. Completion and Acceptance of Work**

Upon completion of the work, remove from within the limits of the railroad right of way all machinery, equipment, surplus materials, or rubbish and leave said rights of way in a neat and orderly condition. After the final inspection has been made and work found to be completed in a satisfactory manner acceptable to the Department of Transportation and the Railroad Company, the Department of Transportation will be notified of the Railroad Company's acceptance in writing by the Railroad Company.

#### **1.5.MEASUREMENT AND PAYMENT**

There will be no direct payment for work covered in this section. Payment at the contract unit prices for the various items in the contract will be full compensation for all work covered by this section.

Repair, removal and replacement of damaged or unacceptable equipment or work under this section will be at no additional cost to the Department. The Department will deduct the cost of Department-owned equipment damaged by the Contractor from money due to the Contractor.

If the Department or City of Fayetteville performs maintenance and emergency service necessary to ensure continuous traffic signal operation, all expenses incurred by the Department or City in implementing this option will be deducted from payment due the Contractor, plus \$2,500 liquidated damage per occasion, per day or any portion thereof, until corrected.

## **2. TEMPORARY TRAFFIC CONTROL**

### **2.1. DESCRIPTION**

Furnish, install, maintain, relocate, and remove temporary traffic control devices in accordance with these Project Special Provisions, the MUTCD, and Roadway Standard Drawings to maintain and control vehicular and pedestrian traffic in a safe and efficient manner during signal system construction. All temporary traffic control devices furnished by the Contractor shall remain the property of the Contractor, unless otherwise specified in the contract.

### **2.2. GENERAL REQUIREMENTS**

#### **A. Maintenance of Traffic**

The Contractor will be required to maintain traffic, both vehicular and pedestrian, within the limits of the project, including roadways that cross or intersect the project, unless otherwise provided for in the contract or approved by the Engineer. The Contractor shall conduct his work in a safe manner that will create a minimum amount of inconvenience to traffic, both vehicular and pedestrian.

Maintain vehicular and pedestrian traffic through work zones in accordance with these Project Special Provisions, the MUTCD, and Roadway Standard Drawings, and 23 CFR 630 Subparts J and K.

Mark all hazards with signs, barricades, drums or other warning devices until the hazard is eliminated.

#### **B. Temporary Lane Closures**

##### **1. General**

Operate all equipment and personnel within the designated work area during lane closures. Do not impede or stop traffic for the purpose of performing construction related work on the traffic side of the lane closure.

Install lane closures with the traffic flow, beginning with devices on the upstream side of traffic. Remove lane closures against the traffic flow, beginning with devices on the downstream side of traffic.

Vehicles used to install or remove lane closures shall have flashing or rotating beacons.

##### **2. Intersections**

When construction proceeds through an intersection, provide flagger(s) and all other necessary Traffic Control as required to direct the traffic through the intersection. When an intersection is signalized, have authorized personnel place the signal in flash mode prior to beginning work in the intersection.

When it is necessary to close a lane of traffic for construction on the departure (downstream) side of an intersection, implement the lane closure on the approach (upstream) side of the intersection. Close the appropriate lane of dual turn lanes that would otherwise turn into the lane that is closed on the departure side of the intersection.

**C. Traffic Stoppage**

Limit the stoppage of traffic to times specified in these Project Special Provisions. Provide enough time between consecutive stoppages to allow the traffic queue to dissipate.

**D. Traffic Control Supervision**

Provide the service of at least one qualified work zone supervisor. The work zone supervisor shall have the overall responsibility for the proper implementation of the traffic control and ensure all employees working inside the NCDOT and City rights-of-way have received the proper training appropriate to the job decisions each individual is required to make.

The work zone supervisor is not required to be on site at all times but shall be available to address concerns of the Engineer. The name and contract information of the work zone supervisor shall be provided to the Engineer prior to or at the preconstruction conference.

Qualification of work zone supervisors shall be done by an NCDOT approved training agency or other approved training provider. For a complete listing of these, see the Work Zone Traffic Control's webpage: <https://connect.ncdot.gov/projects/WZTC/Pages/default.aspx>

Coordinate with and cooperate with traffic control supervisors of adjacent or overlapping construction projects to insure safe and adequate traffic control is maintained throughout the projects at all times including periods of construction inactivity in accordance with Article 105-7 of the Standard Specifications.

**E. Vehicular Access**

Maintain continuous and safe vehicular access, including but not limited to, all residences, businesses, schools, police and fire stations, hydrants, other emergency services, hospitals and mailboxes. Conduct operations in such a manner as to limit the inconvenience to property owners.

**F. Pedestrian Access**

Maintain continuous and safe pedestrian access, including but not limited to, all residences, businesses, schools and mailboxes. Conduct operations in such a manner as to limit the inconvenience to pedestrians. Pay special attention to pedestrian areas used by visually-impaired pedestrians. Coordinate with local Orientation and Mobility Specialists to make appropriate provisions for visually impaired pedestrians when construction activities will disrupt pedestrian paths that they normally use.

Protect open excavations within or adjacent to areas subject to pedestrian traffic from pedestrian intrusion by surrounding the excavation/hazard with orange plastic mesh construction fencing (also referred to as safety fence, tree protection barricade, warning fence, etc.) or other method approved by the Engineer. Do not use tape, flagging, rope or plastic chain strung between barricades, cones or stakes.

Determine the extent of pedestrian needs through engineering judgment or by the traffic control supervisor responsible for the work zone. Inspect the work zone regularly so effective pedestrian traffic is maintained. When pedestrian movement through or around a work site is necessary, provide a separate usable footpath. If the previous pedestrian facility was accessible to pedestrians with disabilities, provide a footpath during temporary traffic control that is accessible. Do not have any abrupt changes in grade or terrain that could cause a tripping hazard or could be a barrier to

wheelchair use. Provide barriers and channelizing devices that are detectable to pedestrians who have visual disabilities. Provide temporary pedestrian facilities that are made of concrete, asphalt or other suitable material as approved by the Engineer at all locations where the existing sidewalks have been removed for construction operations.

Do not sever or move pedestrian facilities for non-construction activities such as parking for vehicles and equipment. Separate pedestrian movements from both work site activity and vehicular traffic.

### **2.3. MATERIALS**

#### **A. Work Zone Traffic Control Devices**

Refer to Division 10 of the Standard Specifications.

Use temporary traffic control devices that comply with 23 CFR 630 Subpart K. Provide a Type 7 material certifications in accordance with Article 106-3 of the Standard Specifications at least 72 hours before use for all used temporary traffic control devices.

Provide temporary traffic control devices that are listed on the WZTC Approved Product List.

#### **B. Work Zone Signs**

Refer to Division 10 of the Standard Specifications:

<b>Item</b>	<b>Section</b>
Barricade Mounted Signs	1089-3
Work Zone Signs	1089-1
Work Zone Sign Supports	1089-2

Portable work zone signs shall be roll up or approved composite substrates. Use portable work zone signs only with portable work zone sign stands specifically designed for one another.

Provide portable work zone sign stands, portable signs and sheeting that meet NCHRP 350 for Category II traffic control devices and are listed on the WZTC Approved Products List.

Provide portable work zone signs and stands that are crash tested together as a system by the manufacturer. Poor performance of portable work zone signs or portable work zone sign stands at any site, whether or not related to a specific contract, will be grounds for non-acceptance of a product on any project under contract.

#### **C. Flashing Arrow Boards**

Refer to Division 10 of the Standard Specifications:

<b>Item</b>	<b>Section</b>
Flashing Arrow Boards	1089-6

Use arrow boards that are on the WZTC Approved Product List.

Poor performance of arrow boards at any site, whether or not related to a specific contract, will be grounds for non-acceptance of a product used under this contract.

**D. Portable Changeable Message Signs**

Refer to Division 10 of the Standard Specifications:

<b>Item</b>	<b>Section</b>
Portable Changeable Message Signs	1089-7

Use portable changeable message signs that are on the WZTC Approved Products List.

Poor performance of portable changeable message signs at any site, whether or not related to a specific contract, will be grounds for non-acceptance of a product used under this contract.

**E. Drums**

Refer to Division 10 of the Standard Specifications:

<b>Item</b>	<b>Section</b>
Drums	1089-5

Provide drums that are on the WZTC Approved Products List.

**F. Cones**

Refer to Division 10 of the Standard Specifications:

<b>Item</b>	<b>Section</b>
Cones	1089-5

Provide cones that are on the WZTC Approved Products List.

**G. Barricades**

Refer to Division 10 of the Standard Specifications:

<b>Item</b>	<b>Section</b>
Barricades	1089-3

Provide barricades that meet NCHRP 350 for Category II traffic control devices and are on the WZTC Approved Products List.

**H. Flaggers**

Refer to Division 10 of the Standard Specifications:

<b>Item</b>	<b>Section</b>
Flaggers	1089-10

**I. Truck Mounted Attenuators**

Refer to Division 10 of the Standard Specifications:

<b>Item</b>	<b>Section</b>
Truck Mounted Impact Attenuators	1089-9



Use TMAs that meet NCHRP 350 Test Level II or III for work zone traffic control devices and are on the WZTC Approved Products List.

Historical performance of the TMA will help determine the future use of the material by the Department, even if the TMA has been approved. Poor performance of TMA at any site, whether or not related to a specific contract, will be grounds for non-acceptance of a product used under this contract.

## **J. Skinny Drums**

Refer to Division 10 of the Standard Specifications:

<b>Item</b>	<b>Section</b>
Skinny Drums	1089-5

Provide skinny drums that are on the WZTC Approved Products List.

### **2.4. CONSTRUCTION METHODS**

#### **A. Work Zone Traffic Control Devices**

Ensure all traffic control devices are inspected and approved before using them on the project. Install temporary traffic control devices before construction operations begin and during the proper phase of construction. Maintain and relocate temporary traffic control devices during the time they are in use. Keep these devices in place as long as they are needed and immediately remove thereafter. When operations are performed in stages, install only those devices that apply to the present conditions.

#### **B. Work Zone Signs**

##### **1. Work Zone Signs (Barricade Mounted)**

Mount approved composite or roll-up signs to barricade rails so that the signs do not cover more than 50% of the top two rails or 33% of the total area of the three rails. Mount signs at least 1 foot from the ground to the bottom of the sign.

##### **2. Work Zone Signs (Portable)**

Install the portable work zone sign and sign stand to stand plumb within 10° left and right, within 20° front and back and be capable of standing erect in windy conditions.

Install roll-up or approved composite signs at least 1 foot from the bottom of the sign to the edge of pavement elevation on two-lane two-way roadways and at least 5 feet from the bottom of the sign to the edge of pavement elevation on multi-lane roadways.

Clean the sign face prior to use.

When not in use for periods longer than 30 minutes, lay the portable work zone sign flat on the ground and collapse the sign stand and lay it flat on the ground.

#### **C. Flashing Arrow Boards**

Use arrow boards that have the capability to display the following modes as a minimum: Flashing Right or Left Arrow, Flashing Double Arrow and Caution Mode (4 outermost corner lamps)..

Do not use straight-line caution or chevron displays.

Mount flashing arrow boards on trucks, trailers, or other mobile units.

Expedite repairs due to failure, malfunction or damage to an arrow board. Furnish another arrow board approved by the Engineer during the repair time. Repair or replace arrow boards immediately; otherwise, suspend all construction activities requiring the use of the sign until the sign is restored to operation.

Perform all maintenance operations recommended by the manufacturer of the sign.

#### **D. Portable Changeable Message Signs**

Mount all portable changeable message signs on a trailer or truck so as to support the message board in a level position. Align and sight the portable changeable message sign to provide optimal driver visibility. Messages on a portable changeable message sign shall consist of no more than 2 phases, and a phase shall consist of no more than 3 lines of text. Each phase shall be capable of being understood by itself, regardless of the order in which it is read. Messages shall be centered and uppercase within each line of the legend. If more than one portable changeable message sign is simultaneously legible to road users, then only one of the signs shall display a sequential message at any given time. As guidance, the display time for each phase shall be at least 2 seconds, and the sum of the display times for both of the phases shall be no more than 8 seconds. Sign operators will adjust the display rate so the 2 phase message can be understood by the motorist approaching the sign at the posted speed limit. Relocate the units for the various stages of construction as needed to adequately inform the motorists.

Provide an experienced operator for the portable changeable message sign during periods of operation to ensure that the messages displayed on the sign panel are in accordance with message content guidelines. Ensure that the message sign is illuminated properly to meet the existing light conditions, and that all adjustments for operation of the sign are made as needed to properly guide motorists.

Expedite repairs due to failure, malfunction, or damage to a portable changeable message sign. Furnish another portable changeable message during the repair time. Repair and/or replace portable changeable message sign immediately; otherwise, suspend all construction activities requiring the use of the sign until the sign is restored to operation.

Perform all maintenance operations recommended by the manufacturer of the sign. Include the periodic cleaning of the sign face and associated solar panels in maintenance operations.

#### **E. Drums**

Use the same type of reflective sheeting on all drums installed at any one time during the life of the project. Spacing of these devices is equal in feet to the speed limit in the taper and twice the speed limit in the tangent sections.

Use a ballasting method in accordance with the manufacturer's specification. When using tire ballasting method, use approved manufacturer's tires and place the tires flush with the ground.

Immediately replace any drum, ballast or reflective sheeting that are torn, crushed, discolored or otherwise damaged.

**F. Cones**

Use reflective adhesive sheeting on all cones used between dusk and dawn. Use the same type of reflective sheeting on all cone collars installed at any one time during the life of the project. Do not use cones in the upstream taper of lane or shoulder closures for multilane roadways and use for no longer than 3 consecutive days.

Use ballasting methods in accordance with manufacturer's specification. Cones may be used on all facilities for daytime and nighttime work with speed limits at or below 55 mph. If used at night, the cones shall have adhesive reflective sheeting and shall meet the height requirements in the Roadway Standard Drawings.

Cones may be used instead of drums, where allowed by the Engineer, on facilities with speed limits above 55 mph, if both the work is performed during daylight conditions and the devices are removed after each work period. Drums shall be used in the tapers.

The maximum spacing for cones on multi-lane roadways is equal in feet to the posted speed limit.

Immediately replace any cone that is torn, crushed, discolored or otherwise damaged.

**G. Barricades**

At the end of the workday, properly close the road where construction equipment accesses a road closure through Type III barricades.

Use sandbags or other approved ballasting methods to prevent overturning of barricades by the wind. If needed, place sandbags or other acceptable ballasting on the feet of the frame. Do not ballast barricades with objects such as rocks or chunks of concrete.

Do not anchor barricades to any pavement surfaces unless such anchoring method has passed the crash test requirement of NCHRP 350 for work zone category II devices.

Point the striped diagonals on the barricade rails in the direction of traffic flow.

**H. Flaggers**

Provide the service of properly equipped and qualified flaggers (see Roadway Standard Drawings No. 1150.01) at locations and times for such period as necessary for the control and protection of vehicular and pedestrian traffic. Anyone who controls traffic is required to be qualified. Qualification consists of each flagger receiving proper training in the set-up and techniques of safely and competently performing a flagging operation. Qualification of flaggers is to be done by an NCDOT approved training agency or other approved training provider. For a complete listing of these, see the Work Zone Traffic Control's webpage.

Prior to beginning work on the project, a Qualification Statement that all flaggers used on the project have been properly trained through an NCDOT approved training resource shall be provided to the Engineer.

Use flagging methods that comply with the guidelines in the MUTCD.

**I. Truck Mounted Attenuator**

Before use, furnish the Engineer detailed brochures, specifications, and other manufacturer's data that completely describes the performance criteria, installation, and instructions for the TMA.

Use only TMAs that meet the crash test requirements of Standard Specifications Article 1089-9(A).

Do not park TMAs against rigid objects (i.e. bridge piers or portable concrete barrier) except as a temporary safety measure and in no case for longer than 72 hours. Install the TMA on a truck that is fully operational, in good running order, and in accordance with the manufacturer's specifications.

Use the appropriate lighting and delineation on the truck and TMAs.

Repair or replace within 24 hours any attenuator that becomes crushed or otherwise damaged so that it will perform its intended purpose. Suspend all construction activities until the attenuator is repaired or replaced. Provide safe control of traffic until the attenuator has been repaired by using approved methods.

**J. Skinny Drums**

Use the same type of reflective sheeting (Type III High Intensity Prismatic or greater) on all skinny drums installed at any one time during the life of the project. Use ballasting methods in accordance with the manufacturer's specification.

Immediately replace any skinny drum, ballast or reflective sheeting that are torn, crushed, discolored or otherwise damaged.

Skinny drums may be used instead of cones on all facilities with speed limits of 55 mph and below. Spacing of these devices is equal in feet to the speed limit in the taper and twice the speed limit or every other skip in the tangent sections.

Skinny drums may be used instead of cones and drums where allowed by the Engineer on facilities with speed limits above 55 mph, if all the following apply:

- 1) The work is performed during daylight conditions,
- 2) The devices are removed after each work period and
- 3) Drums are used in the tapers.

Do not use skinny drums on control-of-access facilities with speed limits above 55 mph that either involve night work or allow devices to remain in place overnight.

Do not use skinny drums for tapers on multilane or control-of-access roadways with speed limits above 55 mph.

Do not intermix with drums or cones unless directed by the Engineer.

**K. Pedestrian Safety**

Install measures for separating pedestrian traffic from the work area and from adjacent vehicular traffic where pedestrian paths are evident or sidewalks are present. Use protective barricades, warning and guidance devices and signs to provide a safe, well-defined passageway for pedestrians.

When a sidewalk must be closed temporarily to perform construction work, refer to Chapter 6D, "Pedestrian and Worker Safety," and Typical Applications 28 and 29 (TA-28 and TA-29) of the 2009 Edition of the Manual on Uniform Traffic Control Devices (MUTCD 2009) for appropriate pedestrian traffic control measures. The MUTCD 2009 is available online at the following web address: <http://mutcd.fhwa.dot.gov>

## **2.5. MAINTENANCE AND INSPECTION**

Submit a proposed traffic control device maintenance schedule and checklist for approval prior to construction. Perform continuous maintenance and scheduled inspections of traffic control devices. Review and maintain all traffic handling measures to ensure that adequate provisions are in place for the safety of the public and workers.

Maintenance activities include cleaning, repair or replacement of temporary traffic control devices that are damaged, torn, crushed, discolored, displaced or deteriorated beyond effectiveness.

If there are traffic control devices in use, perform inspection on a daily basis.

If the name and telephone number of the agency, Contractor or supplier is shown on the non-retroreflective surface of all channelizing devices, use letters and numbers that are a non-reflective color and not over 2 inches in height.

## **2.6. FAILURE TO MAINTAIN TRAFFIC CONTROL**

Failure to maintain temporary traffic control measures and traffic control devices in accordance with this Project Special Provision may result in formal notification of noncompliance. Implement remedial action immediately for imminent danger situations as directed. Implement remedial action within 48 hours after notification of a safety issue that is not an imminent danger situation. See Articles 107-21 and 108-7 of the Standard Specifications.

Failure to comply may result in having the work performed with available forces and equipment. In cases of willful disregard for the safety of the public, the Engineer may proceed immediately to implement the measures necessary to provide the appropriate level of traffic control to ensure that the safety of all concerned parties is maintained.

## **2.7. MEASUREMENT AND PAYMENT**

Nominal dimensions will be used to compute sign panel areas.

*Work zone signs (barricade mounted)* will be measured and paid for as the actual number of square feet satisfactorily installed on barricades and accepted by the Engineer. Payment will be made for the initial installation only. Relocation of signs will be considered incidental to the measurement of the quantity of signs.

*Work zone signs (portable)* will be measured and paid for as the actual number of square feet satisfactorily installed and accepted by the Engineer. Payment will be made for the initial installation only. Relocation of signs will be considered incidental to the measurement of the quantity of signs.

No direct payment will be made for portable work zone sign stands. All portable work zone sign stands will be incidental to the work of providing work zone signs.

*Flashing arrow board* will be measured and paid for as the maximum number of boards that have been satisfactorily placed and accepted by the Engineer in use at any one time during the life of the project as required by the contract. Relocation, repair, replacement and maintenance of arrow boards is considered incidental to the work of this section of the Project Special Provisions.

*Portable changeable message signs* will be measured and paid for as the maximum number of portable changeable message signs acceptably placed and in operation, at any one time during the life of the project. Payment for portable changeable message signs will be made on the following schedule:

70% of the unit bid upon placing the unit in service.

20% of the unit bid when the project is 50% complete.

10% of the unit bid when the project is 100% complete.

Relocation, replacement, repair and maintenance of portable changeable message signs is considered incidental to the work of this section of the Project Special Provisions.

*Drums* will be measured and paid for as the maximum number of drums acceptably placed and in use at any one time during the life of the project. Relocation, repair, replacement and maintenance of cones will be incidental to the work of this section of the Project Special Provisions.

*Cones* will be measured and paid for as the maximum number of cones acceptably placed and in use at any one time during the life of the project. Relocation, repair, replacement and maintenance of cones will be incidental to the work of this section of the Project Special Provisions.

*Barricades (Type III)* will be measured and paid for as the maximum number of linear feet of barricades acceptably placed and in use at any one time during the life of the project. Measurement will be made of the total length of each barricade along one rail. Relocation, repair, replacement and maintenance of barricades will be incidental to the work of this section of the Project Special Provisions.

*Flagger* will be measured and paid for as the actual number of hours that each flagger is satisfactorily provided and accepted by the Engineer during the life of the project. Flagging conducted for the convenience of the Contractor's operations is not compensated. The Department will pay for flaggers, including those used at Y-lines that are used in conjunction with a lane closure. Flaggers used for operations not involving a lane closure will be incidental to that operation and no payment will be made. Any flagger used for less than one hour will be incidental to that operation.

*TMA* will be measured and paid for as the maximum number of TMAs acceptably placed and in use at any one time during the life of the project for all operations other than moving and mobile operations. TMAs will be incidental to all moving and mobile operations. In the case of emergency situations, TMAs will not be paid for when payment has already been made for a stationary unit. Relocation of TMAs will be incidental to the measurement of the quantities of TMAs and no separate payment will be made.

*Skinny drum* will be measured and paid for as the actual number of skinny drums satisfactorily placed, accepted by the Engineer and in use at any one time during the life of the project. Relocation, repair, replacement and maintenance of skinny drums is considered incidental to the work of this section of the Project Special Provisions.

No measurement will be made of orange plastic mesh construction fencing or other approved methods of protecting open excavations/hazards from pedestrian intrusion as such measures will be considered incidental to the excavation work.

If the Contractor fails to maintain acceptable traffic control measures or temporary traffic control devices and the Engineer implements measures necessary to provide the appropriate level of traffic control, the actual cost of performing said work will be deducted from the monies due the Contractor on the contract.

Payment will be made under:

Work Zones Signs (Barricade Mounted) .....	Square Foot
Work Zones Signs (Portable).....	Square Foot
Flashing Arrow Board.....	Each
Portable Changeable Message Sign .....	Each
Drums.....	Each
Cones.....	Each
Barricades (Type III).....	Linear Foot
Flagger .....	Hour
TMA.....	Each
Skinny Drum.....	Each

**3. LAW ENFORCEMENT**

**3.1.DESCRPTION**

Furnish Law Enforcement Officers and marked Law Enforcement vehicles to direct traffic in accordance with the contract.

**3.2.CONSTRUCTION METHODS**

Use uniformed Law Enforcement Officers and marked Law Enforcement vehicles equipped with blue lights mounted on top of the vehicle, and Law Enforcement vehicle emblems to direct or control traffic as required by the Engineer.

**3.3.MEASUREMENT AND PAYMENT**

*Law Enforcement* will be measured and paid for in the actual number of hours that each Law Enforcement Officer is provided during the life of the project as approved by the Engineer. There will be no direct payment for marked Law Enforcement vehicles as they are considered incidental to the pay item.

Payment will be made under:

<b>Pay Item</b>	<b>Pay Unit</b>
Law Enforcement.....	Hour



## 4. SIGNAL HEADS

### 4.1.DESCRPTION

Furnish and install vehicle LED signal heads, visors, interconnecting brackets, wire entrance fittings, mounting assemblies, signal cable, lashing wire, grounding systems and all necessary hardware.

### 4.2.MATERIAL

#### A. General:

Furnish material, equipment and hardware under this section that is pre-approved on the ITS and Signals Qualified Products List (QPL).

Fabricate vehicle signal head housings and end caps from die-cast aluminum. Provide visor mounting screws, door latches, and hinge pins fabricated from stainless steel. Provide interior screws, fasteners, and metal parts fabricated from stainless steel.

Fabricate tunnel and traditional visors from sheet aluminum.

Paint all surfaces inside and outside of signal housings and doors. Paint outside surfaces of tunnel and traditional visors, wire outlet bodies, wire entrance fitting brackets and end caps when supplied as components of messenger cable mounting assemblies, pole and pedestal mounting assemblies, and pedestrian pushbutton housings. Have electrostatically-applied, fused-polyester paint in highway yellow (Federal Standard 595C, Color Chip Number 13538) a minimum of 2.5 to 3.5 mils thick. Do not apply paint to the latching hardware, rigid vehicle signal head mounting brackets for mast-arm attachments, messenger cable hanger components or balance adjuster components.

Have the interior surfaces of tunnel and traditional visors painted an alkyd urea black synthetic baking enamel with a minimum gloss reflectance and meeting the requirements of MIL-E-10169, "Enamel Heat Resisting, Instrument Black."

Where required, provide polycarbonate signal heads and visors that comply with the provisions pertaining to the aluminum signal heads listed on the QPL with the following exceptions:

Fabricate signal head housings, end caps, and visors from virgin polycarbonate material. Provide UV stabilized polycarbonate plastic with a minimum thickness of  $0.1 \pm 0.01$  inches that is highway yellow (Federal Standard 595C, Color Chip 13538). Ensure the color is incorporated into the plastic material before molding the signal head housings and end caps. Ensure the plastic formulation provides the following physical properties in the assembly (tests may be performed on separately molded specimens):

Test	Required	Method
Specific Gravity	1.17 minimum	ASTM D 792
Flammability	Self-extinguishing	ASTM D 635
Tensile Strength, yield, PSI	8500 minimum	ASTM D 638
Izod impact strength, ft-lb/in [notched, 1/8 inch]	12 minimum	ASTM D 256

For pole mounting, provide side of pole mounting assemblies with framework and all other hardware necessary to make complete, watertight connections of the signal heads to the poles and

pedestals. Fabricate the mounting assemblies and frames from aluminum with all necessary hardware, screws, washers, etc. to be stainless steel. Provide mounting fittings that match the positive locking device on the signal head with the serrations integrally cast into the brackets. Provide upper and lower pole plates that have a 1 ¼-inch vertical conduit entrance hubs with the hubs capped on the lower plate and 1 ½-inch horizontal hubs. Ensure that the assemblies provide rigid attachments to poles and pedestals so as to allow no twisting or swaying of the signal heads. Ensure that all raceways are free of sharp edges and protrusions, and can accommodate a minimum of ten Number 14 AWG conductors.

For pedestal mounting, provide a post-top slipfitter mounting assembly that matches the positive locking device on the signal head with serrations integrally cast into the slipfitter. Provide stainless steel hardware, screws, washers, etc. Provide a minimum of six 3/8 X 3/4-inch long square head bolts for attachment to pedestal. Provide a center post for multi-way slipfitters.

For light emitting diode (LED) traffic signal modules, provide the following requirements for inclusion on the Department's QPL for traffic signal equipment.

1. Sample submittal,
2. Third-party independent laboratory testing results for each submitted module with evidence of testing and conformance with all of the Design Qualification Testing specified in section 6.4 of each of the following Institute of Transportation Engineers (ITE) specifications:
  - Vehicle Traffic Control Signal Heads – Light Emitting Diode (LED) Circular Signal Supplement
  - Vehicle Traffic Control Signal Heads – Light Emitting Diode (LED) Vehicle Arrow Traffic Signal Supplement
  - Pedestrian Traffic Control Signal Indications –Light Emitting Diode (LED) Signal Modules.

(Note: The Department currently recognizes Intertek ETL Semko independent testing laboratory. Independent laboratory tests from other laboratories may be considered as part of the QPL submittal at the discretion of the Department.)

3. Evidence of conformance with the requirements of these specifications,
4. A manufacturer's warranty statement in accordance with the required warranty, and
5. Submittal of manufacturer's design and production documentation for the model, including but not limited to, electrical schematics, electronic component values, proprietary part numbers, bill of materials, and production electrical and photometric test parameters.
6. Evidence of approval of the product to bear the Intertek ETL Verified product label for LED traffic signal modules.

In addition to meeting the performance requirements for the minimum period of 60 months, provide a written warranty against defects in materials and workmanship for the modules for a period of 60 months after installation of the modules. During the warranty period, the manufacturer must provide new replacement modules within 45 days of receipt of modules that have failed at no cost to the State. Repaired or refurbished modules may not be used to fulfill the manufacturer's warranty obligations. Provide manufacturer's warranty documentation to the Department during evaluation of product for inclusion on QPL.

**B. Vehicle Signal Heads:**

Comply with the ITE standard "Vehicle Traffic Control Signal Heads". Provide housings with provisions for attaching backplates.

Provide visors that are 8 inches in length for 8-inch vehicle signal head sections. Provide visors that are 10 inches in length for 12-inch vehicle signal heads.

Provide a termination block with one empty terminal for field wiring for each indication plus one empty terminal for the neutral conductor. Have all signal sections wired to the termination block. Provide barriers between the terminals that have terminal screws with a minimum Number 8 thread size and that will accommodate and secure spade lugs sized for a Number 10 terminal screw.

Mount termination blocks in the yellow signal head sections on all in-line vehicle signal heads. Mount the termination block in the red section on five-section vehicle signal heads.

Furnish vehicle signal head interconnecting brackets. Provide one-piece aluminum brackets less than 4.5 inches in height and with no threaded pipe connections. Provide hand holes on the bottom of the brackets to aid in installing wires to the signal heads. Lower brackets that carry no wires and are used only for connecting the bottom signal sections together may be flat in construction.

For messenger cable mounting, provide messenger cable hangers, wire outlet bodies, balance adjusters, bottom caps, wire entrance fitting brackets, and all other hardware necessary to make complete, watertight connections of the vehicle signal heads to the messenger cable. Fabricate messenger cable hanger components, wire outlet bodies and balance adjuster components from stainless steel or malleable iron galvanized in accordance with ASTM A153 (Class A) or ASTM A123. Provide serrated rings made of aluminum. Provide messenger cable hangers with U-bolt clamps. Fabricate washers, screws, hex-head bolts and associated nuts, clevis pins, cotter pins, U-bolt clamps and nuts from stainless steel.

For mast-arm mounting, provide rigid vehicle signal head mounting brackets and all other hardware necessary to make complete, watertight connections of the vehicle signal heads to the mast arms and to provide a means for vertically adjusting the vehicle signal heads to proper alignment. Fabricate the mounting assemblies from aluminum, and provide serrated rings made of aluminum. Provide stainless steel cable attachment assemblies to secure the brackets to the mast arms. Ensure all fastening hardware and fasteners are fabricated from stainless steel.

Provide LED vehicular traffic signal modules (hereafter referred to as modules) that consist of an assembly that uses LEDs as the light source in lieu of an incandescent lamp for use in traffic signal sections. Use LEDs that are aluminum indium gallium phosphorus (AlInGaP) technology for red and yellow indications and indium gallium nitride (InGaN) for green indications. Install the ultra bright type LEDs that are rated for 100,000 hours of continuous operation from -40°F to +165°F. Design modules to have a minimum useful life of 60 months and to meet all parameters of this specification during this period of useful life.

For the modules, provide spade terminals crimped to the lead wires and sized for a #10 screw connection to the existing terminal block in a standard signal head. Do not provide other types of crimped terminals with a spade adapter.

Ensure the power supply is integral to the module assembly. On the back of the module, permanently mark the date of manufacture (month & year) or some other method of identifying date of manufacture.

Tint the red, yellow and green lenses to correspond with the wavelength (chromaticity) of the LED. Transparent tinting films are unacceptable. Provide a lens that is integral to the unit with a smooth outer surface.

### 3. LED Circular Signal Modules:

Provide modules in the following configurations: 12-inch circular sections, and 8-inch circular sections. All makes and models of LED modules purchased for use on the State Highway System shall appear on the current NCDOT Traffic Signal QPL.

Provide the manufacturer's model number and the product number (assigned by the Department) for each module that appears on the 2012 or most recent QPL. In addition, provide manufacturer's certification in accordance with Article 106-3 of the *Standard Specifications*, that each module meets or exceeds the ITE "Vehicle Traffic Control Signal Heads – Light Emitting Diode (LED) Circular Signal Supplement" dated June 27, 2005 (hereafter referred to as VTCSH Circular Supplement) and other requirements stated in this specification.

Provide modules that meet the following requirements when tested under the procedures outlined in the VTCSH Circular Supplement:

<i>Module Type</i>	<i>Max. Wattage at 165° F</i>	<i>Nominal Wattage at 77° F</i>
12-inch red circular	17	11
8-inch red circular	13	8
12-inch green circular	15	15
8-inch green circular	12	12

For yellow circular signal modules, provide modules tested under the procedures outlined in the VTCSH Circular Supplement to insure power required at 77° F is 22 Watts or less for the 12-inch circular module and 13 Watts or less for the 8-inch circular module.

Note: Use a wattmeter having an accuracy of  $\pm 1\%$  to measure the nominal wattage and maximum wattage of a circular traffic signal module. Power may also be derived from voltage, current and power factor measurements.

### 4. LED Arrow Signal Modules

Provide 12-inch omnidirectional arrow signal modules. All makes and models of LED modules purchased for use on the State Highway System shall appear on the current NCDOT Traffic Signal QPL.

Provide the manufacturer's model number and the product number (assigned by the Department) for each module that appears on the 2012 or most recent QPL. In addition, provide manufacturer's certification in accordance with Article 106-3 of the *Standard Specifications*, that each module meets or exceeds the requirements for 12-inch omnidirectional modules specified in the ITE "Vehicle Traffic Control Signal Heads – Light Emitting Diode (LED) Vehicle Arrow Traffic Signal Supplement" dated July 1, 2007 (hereafter referred to as VTCSH Arrow Supplement) and other requirements stated in this specification.

Provide modules that meet the following requirements when tested under the procedures outlined in the VTCSH Arrow Supplement:

<i>Module Type</i>	<i>Max. Wattage at 165° F</i>	<i>Nominal Wattage at 77° F</i>
12-inch red arrow	12	9
12-inch green arrow	11	11

For yellow arrow signal modules, provide modules tested under the procedures outlined in the VTCSH Arrow Supplement to insure power required at 77° F is 12 Watts or less.

Note: Use a wattmeter having an accuracy of  $\pm 1\%$  to measure the nominal wattage and maximum wattage of an arrow traffic signal module. Power may also be derived from voltage, current and power factor measurements.

#### **5. LED U-Turn Arrow Signal Modules:**

Provide modules in the following configurations: 12-inch left u-turn arrow signal modules and 12-inch right u-turn arrow signal modules.

Modules are not required to be listed on the ITS and Signals QPL. Provide manufacturer's certification in accordance with Article 106-3 of the *Standard Specifications*, that each module meets or exceeds the ITE "Vehicle Traffic Control Signal Heads – Light Emitting Diode (LED) Circular Signal Supplement" dated June 27, 2005 (hereafter referred to as VTCSH Circular Supplement) and other requirements stated in this specification.

Provide modules that have minimum maintained luminous intensity values that are not less than 16% of the values calculated using the method described in section 4.1 of the VTCSH Circular Supplement.

Provide modules that meet the following requirements when tested under the procedures outlined in the VTCSH Circular Supplement:

<i>Module Type</i>	<i>Max. Wattage at 165° F</i>	<i>Nominal Wattage at 77° F</i>
12-inch red u-turn arrow	17	11
12-inch green u-turn arrow	15	15

For yellow u-turn arrow signal modules, provide modules tested under the procedures outlined in the VTCSH Circular Supplement to ensure power required at 77° F is 22 Watts or less.

Note: Use a wattmeter having an accuracy of  $\pm 1\%$  to measure the nominal wattage and maximum wattage of a circular traffic signal module. Power may also be derived from voltage, current and power factor measurements.

#### **6. LED Bi-Modal Green-Yellow Arrow Signal Modules**

Provide 12-inch omnidirectional bi-modal arrow signal modules. Ensure both green and yellow arrow indications are in each module with a clear lens that is integral to the unit. Ensure both indications display an incandescent style look.

Modules are not required to be listed on the ITS and Signals QPL. Ensure that both indications along with the module meet or exceed the requirements in sections 1, 2, 3, 4, and 5 of the VTCSH Arrow Supplement and other requirements stated in this specification.

Provide modules that meet the following requirements when tested under the procedures outlined in the VTCSH Arrow Supplement:

Arrow Type	Nominal Wattage at 77° F
12-inch yellow arrow	12
12-inch green arrow	11

Note: Use a wattmeter having an accuracy of  $\pm 1\%$  to measure the nominal wattage and maximum wattage of a circular traffic signal module. Power may also be derived from voltage, current, and power factor measurements.

### C. Signal Cable:

Furnish 16-4 and 16-7 signal cable that complies with IMSA specification 20-1 except provide the following conductor insulation colors:

- For 16-4 cable: white, yellow, red, and green
- For 16-7 cable: white, yellow, red, green, yellow with black stripe tracer, red with black stripe tracer, and green with black stripe tracer. Apply continuous stripe tracer on conductor insulation with a longitudinal or spiral pattern.

Provide a ripcord to allow the cable jacket to be opened without using a cutter. IMSA specification 19-1 will not be acceptable. Provide a cable jacket labeled with the IMSA specification number and provide conductors constructed of stranded copper.

#### 4.3.CONSTRUCTION METHODS

Comply with Section 1705-3 of the Standard Specifications.

#### 4.4.MEASUREMENT AND PAYMENT

*Vehicle Signal Head* (\_\_\_\_) will be measured and paid as the actual number of signal heads of each type, size and number of sections furnished, installed, and accepted.

*Vehicle Signal Head* (\_\_\_\_ *with bi-modal section*) will be measured and paid as the actual number of signal heads of each type, size and number of sections with a bi-modal section furnished, installed, and accepted.

*Signal Cable* will be measured and paid as actual linear feet of signal cable furnished, installed, and accepted. Measurement will be point to point with no allowance for sag. Twenty-five feet will be allowed for vertical segments up or down poles.

No measurement will be made of visors, wire entrance fittings, interconnecting brackets, mounting assemblies, pedestrian pushbuttons, pedestrian signal signs and signal head shifts as these are incidental to furnishing and installing signal heads. No measurement will be made for drip loops, coiled sections or lashing wire as these are incidental to furnishing and installing signal cable.

Payment will be made under:

<b>Pay Item</b>	<b>Pay Unit</b>
Vehicle Signal Head (12", 3 Section).....	Each
Vehicle Signal Head (12", 4 Section).....	Each
Vehicle Signal Head (12", 3 Section with Bi-Modal Section) .....	Each
Signal Cable .....	Linear Foot

**5. MESSENGER CABLE**

**5.1.DESCRPTION**

Furnish and install messenger cable (spanwire) with cable clamps, machine bolts, eye bolts, 3-bolt clamps, eye nuts, split-bolt connectors and all necessary hardware.

**5.2.MATERIAL**

Material, equipment, and hardware furnished under this section shall be pre-approved on the Department's QPL.

Refer to 1091-2 (Wire), 1091-6 (Grounding Electrode), 1098-3 (Messenger Cable), and 1098-6 (Pole Line Hardware ) of the Standard Specifications.

**5.3.CONSTRUCTION METHODS**

Comply with Section 1710-3 of the Standard Specifications.

**5.4.MEASUREMENT AND PAYMENT**

*Messenger Cable* (\_\_\_\_) will be measured and paid as actual horizontal linear feet of messenger cable furnished, installed, and accepted. Measurement will be point to point with no allowance for sag.

No measurement will be made of cable clamps, machine bolts, eye bolts, 3-bolt assemblies, eye nuts, split bolt connectors and pole grounding systems as these will be incidental to furnishing and installing messenger cable.

Payment will be made under:

<b>Pay Item</b>	<b>Pay Unit</b>
Messenger Cable (1/4") .....	Linear Foot



## 6. UNDERGROUND CABLE INSTALLATION

### 6.1. DESCRIPTION

Furnish and install conduit for underground installation with miscellaneous fittings, all necessary hardware, marker tape, backfill, graded stone, paving materials, and seeding and mulching in accordance with Section 1715 of the Standard Specifications

### 6.2. MATERIAL

Material, equipment, and hardware furnished under this section shall be pre-approved on the Department's QPL.

Refer to Articles 1091-3 (Conduit), 1091-4 (Duct and Conduit Sealer), 1018-2 (Backfill), and 545-2 and 545-3 (Graded Stone) of the Standard Specifications.

Furnish underground HDPE conduits as shown in the Plans. All vertical conduits (entrance to electrical service and equipment disconnect and pole mounted cabinet) must be rigid galvanized steel.

### 6.3. CONSTRUCTION METHODS

Install underground conduit in compliance with all requirements of Section 1715-3 of the Standard Specifications and the Plans.

### 6.4. MEASUREMENT AND PAYMENT

*Tracer Wire* will be measured along the horizontal linear feet of tracer wire furnished, installed and accepted. Measurement will be along the approximate centerline of the conduit system. Payment will be made in linear feet. No payment will be made for excess tracer wire in junction boxes and/or cabinets

*Unpaved Trenching (qty) (size)* will be measured horizontal linear feet of trenching for underground conduit installation of each type furnished, installed, and accepted. Measurement will be along the approximate centerline of the conduit system. Payment will be in linear feet.

*Directional Drill (qty) (size)* will be measured horizontal linear feet of directional drill for underground conduit installation furnished, installed, and accepted. Measurement will be along the approximate centerline of the conduit system. Payment will be in linear feet.

No measurement will be made of vertical segments, non-metallic conduit, metallic conduit, conduit sealing material, backfill, graded stone, paved materials, miscellaneous fittings, non-detectable marker tape, pull lines, seeding and mulching as these will be considered incidental to conduit installation.

Payment will be made under:

<b>Pay Item</b>	<b>Pay Unit</b>
Tracer Wire .....	Linear Foot
Unpaved Trenching (1) (2").....	Linear Foot
Unpaved Trenching (2) (2").....	Linear Foot
Directional Drill (1) (2") .....	Linear Foot
Directional Drill (2) (2") .....	Linear Foot
Directional Drill (2) (2") & (1) (5").....	Linear Foot

**7. JUNCTION BOXES**

**7.1.DESCRPTION**

Furnish and install junction boxes (pull boxes) with covers, graded stone, grounding systems, and all necessary hardware. Comply with Section 1716 of the Standard Specifications.

**7.2.MATERIAL**

Material, equipment, and hardware furnished under this section shall be pre-approved on the Department's QPL.

Refer to Article 1098-5 (Junction Boxes) and Section 545 (Graded Stone) of the Standard Specifications.

Provide covers engraved with "NCDOT FIBER OPTIC CABLE" on the top face.

**7.3.CONSTRUCTION METHODS**

Install junction boxes in compliance with all requirements of Section 1716-3 of the Standard Specifications.

Install oversized heavy-duty junction boxes with minimum inside dimensions of 30" x 15" (length x width) for storage of fiber optic communications cables.

**7.4.MEASUREMENT AND PAYMENT**

*Junction Box* (\_\_\_\_\_) will be measured and paid in actual number of junction boxes of each size and type furnished, installed, and accepted.

No measurement will be made of covers, graded stone, and grounding systems as these will be considered incidental to furnishing and installing junction boxes.

Payment will be made under:

<b>Pay Item</b>	<b>Pay Unit</b>
Junction Box (Standard Size).....	Each
Junction Box (Oversized, Heavy Duty) .....	Each

## 8. WOOD POLES

### 8.1.DESCRPTION

Furnish and install wood poles with grounding systems and all necessary hardware in accordance with Section 1720 of the Standard Specifications.

### 8.2.MATERIAL

#### A. General

Material, equipment, and hardware furnished under this section shall be pre-approved on the Department's QPL.

Refer to Articles 1082-3 (Treated Timber and Lumber), 1082-4 (Preservative Treatment), 1091-2 (Wire), and 1091-6 (Grounding Electrodes) of the Standard Specifications.

#### B. Wood Pole

Furnish Class 3 or better wood poles for communication cable attachments that have a minimum length of 40 feet and are of a sufficient length to maintain the minimum required clearances above the roadway and obstructions.

#### C. CCTV Wood Pole

Furnish Class 3 or better wood poles to mount CCTV cameras and cabinets that are a minimum length of 50 feet and are of a sufficient length to permit the CCTV camera to be mounted 35 feet above the ground at the pole.

#### D. Replace Existing Wood Pole

At locations shown in the Plans, the existing wood signal pole is to be removed and replaced with a new CCTV wood pole in the same location and meeting the specifications above.

The Contractor shall stabilize all existing cables that attach to the signal pole prior to removal. The Contractor shall also remove all cables inside vertical risers on the signal pole prior to removal. This may include, but not be limited to, messenger cable, signal cable, lead-in cable, communications cable, and guy wires.

After installing the CCTV wood pole, the Contractor shall attach all existing cables and guys in compliance with these Project Special Provisions and the Standard Specifications.

### 8.3.CONSTRUCTION METHOD

Install wood poles in compliance with all requirements of Section 1720-3 of the Standard Specifications.

### 8.4.MEASUREMENT AND PAYMENT

*Wood Pole* will be measured and paid as the actual number of wood poles for communication cable attachments furnished, installed, and accepted.

*CCTV Wood Pole* will be measured and paid as the actual number of wood poles for CCTV camera attachments furnished, installed, and accepted.

*Remove and Replace Existing Wood Signal Pole* will be measured and paid as the actual number of existing wood signal poles removed, replaced with a CCTV wood pole, and accepted. No separate pay item will be made for labor, equipment, or materials required while disconnecting and reattaching cables and wires or for any temporary relocations made before acceptance. Removal and disposal of any items not re-used will be considered incidental to this pay item. Any cables damaged during the work required for this item shall be replaced at no cost to the City or Department.

No measurement will be made for installing grounding systems as these will be incidental to furnishing and installing poles.

Payment will be made under:

<b>Pay Item</b>	<b>Pay Unit</b>
Wood Pole.....	Each
CCTV Wood Pole.....	Each
Remove and Replace Existing Wood Signal Pole .....	Each

**9. GUY ASSEMBLIES**

**9.1.DESCRPTION**

Furnish and install guy assemblies with all necessary hardware.

**9.2.MATERIAL**

Material, equipment, and hardware furnished under this section shall be pre-approved on the Department's QPL.

Refer to 1098-6 (Pole Line Hardware) and 1098-7 (Guy Assembly) of the Standard Specifications.

**9.3.CONSTRUCTION METHODS**

When installing messenger cable for supporting only communications cable, use approved one-bolt attachment method for attaching messenger cable and guy assembly.

Bond guy assembly to existing pole ground using parallel groove clamp or equivalent. If existing poles do not have a grounding system, install new grounding system for bonding guy assembly that complies with Article 1720-3.

Do not attach to existing guy assemblies unless specifically approved by owner.

**9.4.MEASUREMENT AND PAYMENT**

*Guy Assembly* will be measured and paid as the actual number of guy assemblies furnished, installed and accepted.

No measurement will be made of guy cable, guy guards, anchors, clamps, grounding systems or fittings as these will be incidental to furnishing and installing guy assemblies.

Payment will be made under:

<b>Pay Item</b>	<b>Pay Unit</b>
Guy Assembly.....	Each

**10. RISER ASSEMBLIES**

**10.1. DESCRIPTION**

Furnish and install riser assemblies with clamp-on, aluminum weatherheads or heat shrink tubing, galvanized pole attachment fittings and all necessary hardware.

**10.2. MATERIAL**

Material, equipment, and hardware furnished under this section shall be pre-approved on the Department's QPL.

Refer to 1091-2 (Wire), 1091-3 (Rigid Metallic Conduit), 1091-6 (Grounding Electrodes), 1098-4 (Riser Sealing Devices), and 1098-6 (Pole Line Hardware) of the Standard Specifications.

**10.3. CONSTRUCTION METHOD**

Install riser assemblies in compliance with all requirements of Section 1722-3 of the Standard Specifications.

**10.4. MEASUREMENT AND PAYMENT**

*\_\_\_" Riser with \_\_\_* will be measured and paid as the actual number of risers of each type and size furnished, installed and accepted. No measurement will be made of weatherheads, heat shrink tubing or pole attachment fittings as these will be incidental to furnishing and installing risers.

*Heat Shrink Tubing Retrofit Kit* will be measured and paid as the actual number of heat shrink tubing retrofit kits furnished, installed and accepted.

Payment will be made under:

<b>Pay Item</b>	<b>Pay Unit</b>
2" Riser with Weatherhead .....	Each
2" Riser with Heat Shrink Tubing .....	Each
Heat Shrink Tubing Retrofit Kit .....	Each

**11. INDUCTIVE DETECTION LOOPS**

**11.1. DESCRIPTION**

Furnish and install inductive detection loops with loop slot sealant, loop wire, conduit with fittings and all necessary hardware.

**11.2. MATERIAL**

Furnish material, equipment and hardware under this section that is pre-approved on the ITS and Signals QPL.

Provide the Engineer a Type 3 material certification and MSDS for the sealant in accordance with Article 106-3.

Refer to 1098-8 (Inductive Detection Loops) of the Standard Specifications.

**11.3. CONSTRUCTION METHOD**

Install inductive detection loops in compliance with all requirements of Section 1725-3 of the Standard Specifications.

**11.4. MEASUREMENT AND PAYMENT**

*Inductive Loop Sawcut* will be measured and paid as the actual linear feet of inductive loop sawcut furnished, installed, and accepted.

No measurement will be made of loop slot sealant, loop wire, conduit and conduit fittings as these will be incidental to furnishing and installing inductive detection loops.

Payment will be made under:

<b>Pay Item</b>	<b>Pay Unit</b>
Inductive Loop Sawcut .....	Linear Foot



**12. LEAD-IN CABLE**

**12.1. DESCRIPTION**

Furnish and install lead-in cable with all necessary hardware to be used in conjunction with inductive detection loops.

**12.2. MATERIAL**

Furnish material, equipment and hardware under this section that is pre-approved on the ITS and Signals QPL.

Refer to 1098-6 (Lashing Wire and Hardware), 1098-6 (Wrapping Tape), and 1098-9 (Lead-In Cable) of the Standard Specifications.

**12.3. CONSTRUCTION METHOD**

Install lead-in cable in compliance with all requirements of Section 1726-3 of the Standard Specifications.

**12.4. MEASUREMENT AND PAYMENT**

*Lead-in Cable* (\_\_\_\_) will be measured and paid as the actual linear feet of lead-in cable furnished, installed, and accepted. Measurement will be made by calculating the difference in length markings located on outer jacket from start of run to end of run for each run. Terminate all cables before determining length of cable run.

If markings are not visible, measurement will be point to point with no allowance for sag. Twenty-five feet will be allowed for vertical segments up or down poles.

Payment will be made under:

<b>Pay Item</b>	<b>Pay Unit</b>
Lead-In Cable (14-2).....	Linear Foot

### 13. FIBER OPTIC CABLE

#### 13.1. DESCRIPTION

Furnish and install single mode fiber-optic (SMFO) communications cable and drop cable assemblies with grounding systems, fiber-optic cable storage racks (snow shoes), communications cable identification markers, lashing wire, and all necessary hardware.

#### 13.2. MATERIAL

Furnish material, equipment, and hardware under this section that is pre-approved on the Department's QPL.

Refer to Articles 1098-10(A) (SMFO Communications Cable), 1098-10(C) (Communications Cable Identification Markers), 1098-10(D) (Fiber-Optic Cable Storage Guides), and 1098-6 (Pole Line Hardware) of the Standard Specifications.

Provide communications cable identification markers with 910-486-1452 as the contact telephone number.

#### 13.3. CONSTRUCTION METHODS

Install fiber-optic cable in compliance with all requirements of Section 1730-3 of the Standard Specifications.

Do not install any communications cables in the same conduit or junction box as power cables.

Store 30 feet of each fiber optic cable entering a junction box or field equipment. Store 100 feet of each fiber optic cable being spliced in an underground splice enclosure located in a junction box. Coil all stored cable in the bottom of the junction box and in a manner that does not violate the maximum bending radius of the cable.

#### 13.4. MEASUREMENT AND PAYMENT

*Communications cable* (\_\_\_\_-fiber) will be measured and paid as the actual linear feet of fiber-optic cable of each fiber count furnished, installed, and accepted. Measurement will be made by calculating the difference in length markings located on outer jacket from start of run to end of run for each run. Terminate all fibers before determining length of cable run.

*Drop Cable* will be measured and paid as linear feet of fiber-optic drop cable (12-fiber) assemblies furnished, installed and accepted. Sag and vertical segments will not be paid as these distances are incidental to the installation of drop cable assemblies.

No measurement will be made for terminating, splicing, and testing fiber-optic cable, communications cable identification markers, or fiber-optic cable storage racks, as these will be considered incidental to the installation of fiber-optic cable.

Payment will be made under:

<b>Pay Item</b>	<b>Pay Unit</b>
Communications Cable (24-Fiber) .....	Linear Foot
Communications Cable (48-Fiber) .....	Linear Foot
Drop Cable .....	Linear Foot

## 14. FIBER OPTIC SPLICE CENTERS

### 14.1. DESCRIPTION

Furnish and install fiber-optic interconnect centers, fiber-optic splice enclosures, and all necessary hardware.

Modify existing fiber optic interconnect centers and/or splice enclosures as shown in the plans. Refer to manufacturer's recommendations for opening, modifying and re-sealing the existing fiber optic interconnect center and/or fiber optic splice enclosures.

### 14.2. MATERIALS

Material, equipment, and hardware furnished under this section shall be pre-approved on the Department's QPL.

Refer to Article 1098-11 (Fiber-Optic Splice Centers) of the Standard Specifications.

For locations where a single drop cable or two 12-fiber cables enter and terminate inside a cabinet, furnish standard-size interconnect centers with 12-position modules. For locations where more than two 12-fiber cables enter and terminate inside a cabinet, furnish oversized interconnect centers with sufficient number of modules.

### 14.3. CONSTRUCTION METHODS

#### A. General

Install fiber-optic splice centers, perform termination and splicing, and test in compliance with all requirements of Section 1731-3 of the Standard Specifications.

**Contractor is responsible for field verifying existing splicing. The Contractor shall coordinate with the Engineer where existing splicing is not as expected with regards to the number and size of existing cables shown on the Splice Details or the existing connections between cables shown on the Splice Details.**

#### B. Testing

Provide written notification a minimum of 10 days before beginning OTDR tests.

After splicing is completed, perform bi-directional OTDR tests on each fiber, including unused fibers. Install a 1,000-ft pre-tested launch cable between the OTDR and fiber optic cable to be tested and a 1,000-ft pre-tested destination cable on the end of the fiber optic cable to be tested. Ensure each launch cable has been tested and is compatible with the fiber being installed. Provide Engineer with test results of the launch cable before use. Re-test or replace launch cable at Engineer's request.

Ensure fusion splice losses do not exceed 0.05 dB and connectors have a loss of 0.5 dB or less. If any fiber exceeds maximum allowable attenuation or if fiber properties of the cable have been impaired, take appropriate actions up to and including replacement of the fiber cable.

Clearly label each OTDR trace identifying a starting and ending point for all fibers being tested. Record the attenuation level of each fiber and clearly indicate OTDR trace results in report format. Furnish 2 hard copies of each of the OTDR trace results and electronic copies of all trace results along with digital photographs showing workmanship for each splice on a compact disk. Furnish the manufacturer's make, model number and software version of the OTDR used for testing.

Furnish to the Engineer 2 copies of the software needed to view the OTDR traces electronically.

**14.4. MEASUREMENT AND PAYMENT**

*Interconnect center* (\_\_\_) will be measured and paid as the actual number of fiber-optic interconnect centers of each type furnished, installed, and accepted.

*Splice enclosure* will be measured and paid as the actual number of fiber-optic splice enclosures furnished, installed, and accepted. No measurement will be made between aerial, underground, manhole, or junction box installation of the fiber-optic splice enclosure.

*Modifying splice enclosure* will be measured and paid as the actual number of fiber-optic splice enclosures modified and accepted. No measurement will be made between aerial, underground, splice cabinet, manhole, or junction box installation of the fiber-optic splice enclosure.

No measurement will be made of splice trays, pigtails, jumpers, connector panels, testing and any corrective actions, repairs and replacements needed for exceeding maximum allowable attenuation or other defects, as these will be considered incidental to furnishing and installing fiber-optic interconnect centers and splice enclosures and modifying splice enclosures.

Payment will be made under:

<b>Pay Item</b>	<b>Pay Unit</b>
Interconnect Center (Standard) .....	Each
Interconnect Center (Oversized) .....	Each
Splice Enclosure.....	Each
Modify Splice Enclosure.....	Each

**15. SPLICE CABINET (FIBER OPTICS)**

**15.1. DESCRIPTION**

Furnish and install splice cabinets and all necessary hardware in accordance with the plans and specifications for the purpose of splicing and terminating fiber-optic cable.

**15.2. MATERIAL**

Furnish NEMA Type 4 splice cabinets of sufficient size to accommodate the fiber-optic interconnect center. Provide sufficient size so that the equipment installed will not occupy more than 60 percent of the total cabinet volume.

**15.3. CONSTRUCTION METHODS**

Locate cabinets so as not to obstruct sight distance of vehicles turning on red.

Install base mounted cabinets as shown on the plans and as approved by the Engineer. Refer to Section 1750 - Signal Cabinet Foundations of the Standard Specifications for installation requirements for the foundations. The following exceptions are made:

- Install only the required number of conduits as shown on the plans plus one additional spare stub out conduit.
- Do not provide a 24-inch working area on the backside of the cabinet. Provide only a 24-inch working area measured from the front of the cabinet and 3 inch lip measured from the sides and back of the cabinet.
- All other requirements apply.

**15.4. MEASUREMENT AND PAYMENT**

Actual number of base mounted fiber-optic splice cabinets furnished, installed, and accepted.

No measurement will be made for the cabinet foundation as it will be covered under Section 1750 – Signal Cabinet Foundations of the Standard Specifications.

Payment will be made under:

<b>Pay Item</b>	<b>Pay Unit</b>
Splice Cabinet .....	Each

**16. DELINEATOR MARKERS**

**16.1. DESCRIPTION**

Furnish and install delineator markers with all necessary hardware.

**16.2. MATERIALS**

Material, equipment, and hardware furnished under this section shall be pre-approved on the Department’s QPL. Refer to Article 1098-13 (Delineator Markers) of the Standard Specifications.

Provide delineator markers with 910-486-1452 as the contact telephone number.

**16.3. CONSTRUCTION METHODS**

Install delineator markers in compliance with all requirements of Section 1733-3 of the Standard Specifications.

**16.4. MEASUREMENT AND PAYMENT**

Delineator marker will be paid for by the actual number furnished, installed, and accepted.

Payment will be made under:

<b>Pay Item</b>	<b>Pay Unit</b>
Delineator Marker .....	Each

**17. ETHERNET CABLE****17.1. DESCRIPTION**

Furnish and install Ethernet cable to serve as interconnect between Ethernet switches and/or field devices.

**17.2. MATERIAL**

Furnish CAT5E Ethernet cable that is suitable for outdoor installation and meets or exceeds the following standards:

- 4-pair shielded twisted pair cable
- 24 AWG (minimum) solid bare copper conductor
- Meets or exceeds CAT5E specifications
- High-density polyethylene insulation, PVC jacket
- Compliant with EIA/TIA standards
- UL/CSA listed
- UV Stabilized PE Jacket
- Gel Filled
- Meets TIA/EIA 568B.2 Networking Standard
- Supports 10/100/1000/10,000Mbps
- Mean Power Sum for Equal Level Far End Crosstalk (ELFEXT): 45dB/kft (minimum) at 772kHz
- Worst Pair Power Sum for ELFEXT: 40dB/kft (minimum) at 772kHz
- Mean Power Sum for Near-end Crosstalk (NEXT): 42dB/kft (minimum) at 772 kHz
- Operating Temperature: Rated from -10 to +60 Celsius
- Average mutual capacitance: 90nf/mile (maximum)

Have the manufacturer factory test the Ethernet cable on reels for each pair's mutual capacitance, crosstalk loss, insulation resistance, and conductor resistance. Furnish the Engineer with a certified report for each reel showing compliance with these Project Special Provisions, the factory test results, and the manufactured date of the cable. The contractor shall not use Ethernet cable manufactured more than one year before the date of installation.

Cables where both ends will terminate in an RJ-45 connector, both ends should be installed with



punchdown female jacks at both ends of the factory-manufactured cable, to be connected at both ends with short 3-6' patch cables.

Cable length with end patch connectors shall not exceed 295 feet.

**17.3. CONSTRUCTION METHODS**

Install Ethernet cable in conduits at locations shown in the Plans. Allow a minimum of 10 feet of cable slack.

Ethernet cables shall not be spliced.

All cables shall be labeled with water proof, smear resistant labels that denote the equipment cabinets or housing they are run from and the device and identifier for that device they are connected to.

Install underground Ethernet cable in conduit described in these Special Provisions and as shown in the Plans.

The contractor shall not exceed 80 percent of the manufacturer's maximum pulling tension when installing underground Ethernet cable. Use a clutch device (dynamometer) so as not to exceed the allowable pulling tension if the cable is pulled by mechanical means. Do not use a motorized vehicle to generate cable-pulling forces.

Keep tension on the cable reel and the pulling line at the start of each pull. Do not release the tension in the cable if the pulling operation is halted. Restart the pulling operation by gradually increasing the tension until the cable is in motion.

**17.4. MEASUREMENT AND PAYMENT**

*Ethernet cable* will be measured and paid as linear feet of outdoor rated Ethernet cable furnished, installed, and accepted. Sag and vertical segments will not be paid for as these distances are considered incidental to the installation of the cable.

Ethernet cabling installed within equipment cabinets, within rooms, and within buildings are incidental and will not be paid for under this item.

No measurement will be made for terminating and testing of the cable, connectors, cable identification markers, and grounding, as these will be considered incidental to the installation of the Ethernet cable.

Payment will be made under:

<b>Pay Item</b>	<b>Pay Unit</b>
Ethernet Cable.....	Linear Feet

**18. REMOVE EXISTING COMMUNICATIONS CABLE**

**18.1. DESCRIPTION**

Remove existing communications cable.

**18.2. CONSTRUCTION METHODS**

Remove existing communications cable in compliance with all requirements of Section 1734-2 of the Standard Specifications.

**18.3. MEASUREMENT AND PAYMENT**

*Remove Existing Communications Cable* will be measured in horizontal linear feet of existing communications cable removed and accepted. Payment will be in linear feet. Sag, vertical segments or spare segments of communications cable will not be paid as these distances will be incidental to the removal of existing communications cable.

No additional measurement will be made for multiple cables being removed from the same conduit or same pole. Where multiple adjacent conduits exist (each containing multiple cables), each conduit will be measured and paid separately. No payment will be made for cable that cannot be removed and is abandoned in place.

No measurement will be made of the removal of messenger cable and pole attachment hardware, as these will be incidental to removing existing communications hardware.

Payment will be made under:

<b>Pay Item</b>	<b>Pay Unit</b>
Remove Existing Communications Cable .....	Linear Foot

**19. BACK PULL FIBER OPTIC CABLE**

**19.1. DESCRIPTION**

Back pull and store or back pull and reinstall existing communications cable.

**19.2. CONSTRUCTION METHODS**

During project construction where instructed to back pull existing aerial sections of fiber optic communications cable, de-lash the cable from the messenger cable and back pull the cable to a point where it can be stored or re-routed as shown on the plans. If instructed, remove and discard the existing messenger cable and pole mounting hardware once the cable is safely out of harm's way.

During project construction where instructed to back pull existing underground sections of fiber optic communications cable, back pull the cable to a point where it can be stored or re-routed as shown on the plans. If instructed, remove abandoned junction boxes and backfill with a suitable material to match the existing grade. Leave abandoned conduits in place unless otherwise noted.

Where instructed, re-pull the fiber optic cable back along messenger cable or through conduit systems.

**19.3. MEASUREMENT AND PAYMENT**

*Back Pull Fiber Optic Cable* will be paid for as the actual linear feet of fiber optic cable back pulled and either stored or back pulled and rerouted. Payment is for the actual linear feet of cable back pulled.

No payment will be made for removing messenger cable and pole mounting hardware or removing junction boxes and back filling to match the surrounding grade as these items of work will be considered incidental to back pulling the fiber optic cable.

Payment will be made under:

<b>Pay Item</b>	<b>Pay Unit</b>
Back Pull Fiber Optic Cable .....	Linear Foot

**20. CABLE TRANSFERS**

**20.1. DESCRIPTION**

Remove and reinstall existing communications cable for pole relocations.

**20.2. CONSTRUCTION METHODS**

Transfers of existing communications cable to new poles may be required during this project. Perform transfers as directed by the Engineer. Remove existing communications cables from pole to be removed and reinstall these communications cables and any existing attachment hardware on new pole. Remove all communications hardware from existing pole. Furnish and install any new attachment hardware as required.

**20.3. MEASUREMENT AND PAYMENT**

*Cable Transfer* will be measured and paid as the actual number of cable transfers with attachment hardware to new poles furnished, installed and accepted.

The transfer of signal cables from an existing signal pole to a new CCTV pole will be measured and paid for according to the "Remove and Replace Existing Wood Signal Pole" pay item in these Project Special Provisions.

Payment will be made under:

<b>Pay Item</b>	<b>Pay Unit</b>
Cable Transfer.....	Each

## 21. WIRELESS ETHERNET RADIO SYSTEM

### 21.1. DESCRIPTION

Furnish and install a spread spectrum wireless Ethernet radio system with all necessary hardware and signage in accordance with the Plans and Project Special Provisions to provide a data link between field devices. Provide a radio system with a bi-directional, full duplex communications channel between multiple “line-of-sight” antennas to the fiber optic network using license free, spread spectrum technology. Radio systems for transmission of compressed digital video shall operate at the 2.4 or 5.8 GHz frequency.

Furnish material and workmanship conforming to the *National Electrical Code* (NEC), the *National Electrical Safety Code* (NESC), Underwriter’s Laboratories (UL) or a third-party listing agency accredited by the North Carolina Department of Insurance, and all local safety codes in effect on the date of advertisement.

### 21.2. MATERIALS

#### A. Field Set-up Software

The Field Set-up Software shall be a Window-based software program that uses a GUI (Graphical User Interface) to provide the following features at a minimum:

- Remote programming
- Remote radio configuration
- Remote maintenance
- Remote diagnostics
- Spectrum analyzer

Furnish software supplied with drivers to allow easy set-up with all industry standard traffic signal controllers, including 2070L/2070E controllers containing custom software written specifically for the North Carolina Department of Transportation. Manufacturer is required to develop additional drivers (at no charge) for other equipment not supported by their existing pre-written Driver Package when needed.

#### B. Central Management Software

The Central Management Software shall provide the following minimum features:

- Window-based software program that uses a GUI (Graphical User Interface)
- Network mapping: online/offline status, Auto Discovery
- Wireless diagnostics: Wireless link status, Signal level, Spectrum Analyzer, Antenna Alignment
- Network Diagnostics: Bandwidth testing, Network traffic monitoring, Ping test capabilities
- Event logs
- System configuration utility: Security, RF channels, Vlan, configuration system backup

- Email alert capabilities
- GPS identification

### C. 2.4 GHz Broadband (Ethernet) Radio

Furnish 2.4 GHz Broadband Ethernet radio transceivers with Field Set-up Software.

Furnish material that is certified by Underwriter's Laboratories (UL) or a third-party listing agency accredited by the North Carolina Department of Insurance, and all local safety codes in effect on the date of advertisement.

Furnish 2.4 GHz broadband Ethernet radio transceivers that meet the following minimum specifications:

Wireless Interface		
Frequency Range	2.4 – 2.4835 GHz	
Modulation	DSSS/OFDM, BPSK, QPSK, 16QAM, 64QAM	
Receiver Sensitivity	-97 to -74 dBm	
Peak Transmit Power	28 dBm @ 600 mW OR 30 dBm @ 1000 mW	
Channel Widths	20MHz, 40MHz	
Wireless Interface Protocols	802.11	
Data Rate	Up to 108M bps	
LED's	RSSI and power LED	
Reset	Push Button	
GPS Function	Embedded	
Wireless Networking	Bursting,	Compression
	Dynamic Ack Timeout	TLS EAP Method
	Pass through EAP Method	Hardware Retries
	Preamble Mode	Periodic Calibration
	Disconnect Timeout	Onfail Retry
	CSMA Disable	
Security	801.11i-WPA-PSK	802.11i-WPA2-PSK
	802.11i-WPA-EAP	802.11i-WPA2-EAP
	802.11i-TKIP	802.11iAES-CCM
	80211i-802.1x	802i-RSN
	Radius Authentication	MAC Access Control List

IEEE Networking Features	802.11e	WMM and QOS
	802.11h	DFS and TPC
	802.1d	Ethernet Bridging
	802.1p	Traffic Prioritization
	802.1q	VLAN
	802.1s	Spanning Tree
	801.1w	Rapid Spanning Tree
	802.3-1998	Ethernet
	802.3ab	Gigabit Ethernet
	802.3ac	Extended Frame Size for 801.1q & 802.1p Support
	802.3ad	Link Aggregation/Port Bonding/Port Trunking
	802.3i	10 Mbps Ethernet
	802.3u	100 Mbps Ethernet and Auto-Negotiation
	802.3x	Full Duplex and Flow Control
Additional Networking Features	OSPF	STP/TFTP
	HTTP	Telnet
	SSH	SNMP
	Syslog	Routing
	Firewall/NAT	NTP
	DHCP Server/Client	blank
Software	IP Discovery Tool	Local or Remote Configuration
	Network-Wide Diagnostics	Bandwidth Test Tool
	Spectrum Analysis/AP Scan Tool	Real Time RSSI
	Client Connection Quality	Built-in Audio Aiming Tool
	Configuration File Management	blank
Power	Power over Ethernet (POE) (10/100/1000 injector) with Surge Protector; 10 – 28 VDC: 150 ft, Cat5e or better industrial outdoor rated cable with waterproof connector	

Environmental (IP67)	-40°C to +80°C
Antennas	Supports: Omni, Yagi, single panel, parabolic and/or sectoral
Certification	FCC Part 15.247

**D. 2.4 GHz Broadband (Ethernet) Dual Radio (Integrated Panel)**

Furnish a 2.4 GHz Broadband Ethernet Dual Radio Transceiver with a RJ-45 Ethernet 10/100 Base T connector (auto crossover) with an integrated 20 dBi gain panel antenna and Field Set-up Software. Ensure the dual radio design is designed to support a second antenna configuration (yagi/single panel) through one additional (1) N-Type-Female coaxial port.

**E. 2.4 GHz Panel (Standalone) Antenna – (20 dBi Gain)**

Applications	2.4 GHz ISM band	
IEEE Compliant	802.11b	802.11g
	802.11n	
Uses	Point-to-point; point-to-multipoint	
Electrical Specifications		
Frequency	2400 to 2500 MHz	
Gain	20 dBi	
Polarization	Horizontal & Vertical	
Vertical Beam Width	19°	
Horizontal Beam Width	19°	
Impedance	50 ohms	
Max Input Power	50 Watts	
VSWR	1.5:1 avg.	
Lightning Protection	DC ground	
Mechanical		
Radome Material	UV-inhibited Polymer/ Fiberglass/Weatherproof	
Dimensions	12 ½" * 12 ½" * 1" (approx.)	
Mounting	4 bolt pattern to Pelco type bracket	
Wind Survival Rating	150 MPH	
Connector	N-Female	
Mounting	Adjustable hardware (horizontal and vertical tilt capability) included for mount to 1 ½" pipe	

**F. 5.8 GHz Broadband (Ethernet) Radio**

Furnish 5.8 GHz Broadband Ethernet radio transceivers with with Field Set-up Software.

Furnish material that is certified by Underwriter's Laboratories (UL) or a third-party listing agency accredited by the North Carolina Department of Insurance, and all local safety codes in effect on the date of advertisement.

Furnish 5.8 GHz broadband Ethernet radio transceivers that meet the following minimum specifications:



Wireless Interface		
Frequency Range	5.150 – 5.825 GHz	
Modulation	OFDM, BPSK, QPSK, 16QAM, 64QAM	
Receiver Sensitivity	-94 to -74 dBm	
Peak Transmit Power	28 dBm @ 600 mW OR 30 dBm @ 1000 mW	
Channel Widths	20MHz, 40MHz	
Wireless Interface Protocols	802.11a/n	
Data Rate	Up to 300Mbps	
LED's	RSSI and power LED	
Reset	Push Button	
Ethernet Link	10/100/1000Base-T	
GPS Function	Embedded	
Wireless Networking	Bursting,	Compression
	Dynamic Ack Timeout	TLS EAP Method
	Pass through EAP Method	Hardware Retries
	Preamble Mode	Periodic Calibration
	Disconnect Timeout	Onfail Retry
	CSMA Disable	Station Channel Scan List
Security	801.11i-WPA-PSK	802.11i-WPA2-PSK
	802.11i-WPA-EAP	802.11i-WPA2-EAP
	802.11i-TKIP	802.11i-AES-CCM
	802.11i-802.1x	802i-RSN
	Radius Authentication	MAC Access Control List
	128/256 Encryption	

IEEE Networking Features	802.11e	WMM and QOS
	802.11h	DFS and TPC
	802.1d	Ethernet Bridging
	802.1p	Traffic Prioritization
	802.1q	VLAN
	802.1s	Spanning Tree
	801.1w	Rapid Spanning Tree
	802.3-1998	Ethernet
	802.3ab	Gigabit Ethernet
	802.3ac	Extended Frame Size for 801.1q & 802.1p Support
	802.3ad	Link Aggregation/Port Bonding/Port Trunking
	802.3i	10 Mbps Ethernet
	802.3u	100 Mbps Ethernet and Auto-Negotiation
	802.3x	Full Duplex and Flow Control
Additional Networking Features	OSPF	FTP
	Telnet	SSH
	SSH	SNMP
	Firewall/NAT	DHCP Server/Client
Software	IP Discovery Tool	Local or Remote Configuration
	Network-Wide Diagnostics	Bandwidth test Tool
	Spectrum Analysis/AP Scan Tool	Real Time RSSI
	Client Connection Quality	Built-in Audio Aiming Tool
	Configuration File Management	blank
Power	Power over Ethernet (POE) (10/100/1000 injector) with Surge Protector; 10 – 28 VDC; 150 ft, Cat5e or better industrial outdoor rated cable with waterproof connector	
Environmental (IP67)	-45°C to +70°C	

Antennas	Supports: Omni, Yagi, single panel, parabolic and/or sectoral
Certification	FCC Part 15.247

### G. 5.8 GHz Broadband (Ethernet) Dual Radio (Integrated Panel)

Furnish a 5.8 GHz Broadband Ethernet Dual Radio Transceiver with a RJ-45 Ethernet 10/100 Base T connector (auto crossover) with an integrated 23 dBi gain panel antenna and Field Set-up Software. Ensure the dual radio design is designed to support a second antenna configuration (yagi/single panel) through one additional (1) N-Type-Female coaxial port. Provide Field Set-up Software with each radio.

### H. 5.8 GHz Panel (Standalone) Antenna – (23 dBi Gain)

Applications	5.8 GHz ISM band	
IEEE Compliant	802.11a	802.11b
	802.11g	
Uses	Point-to-point; point-to-multipoint	
Electrical Specifications		
Frequency	5725 to 5825 MHz	
Gain	23 dBi	
Polarization	Horizontal or Vertical	
-3dB Beamwidth Vertical/Horizontal	10°/10°	
Impedance	50 ohms	
Max Input Power	30 Watts	
VSWR	< 1.5:1 avg.	
Lightning Protection	DC ground	
Mechanical		
Radome Material	UV-inhibited Polymer /fiberglass/weatherproof	
Dimensions	12 ½" * 12 ½" * 1" (approx.)	
Mounting	4 bolt pattern to Pelco type bracket	
Wind Survival Rating	150 MPH	
Connector	N-Female	
Mounting	Adjustable hardware (horizontal and vertical tilt capability) included for mount to 1 ½" pipe	

### I. Antenna Mounting Hardware Kit

Furnish an antenna mounting kit to support the antenna when attached to a metal pole, mast arm, or wood pole.

Ensure the Antenna Mounting Hardware Kit includes the following:

- 96" galvanized cable with stainless steel bolt with a nut and lock washer assembly on each end.

- Pole base plate accepts a 1 ½” NPT aluminum pipe, and provides a surface that is a minimum of 6 ¾ inch long by 4 ¼” to provide contact with the surface of the pole. Ensure the pole base plate is designed to allow both ends of the 96” galvanized cable to be secured and tightened to the base plate. Furnish a stainless steel set screw to secure the 1 ½” NPT aluminum pipe to the base plate.
- A 90 degree, die cast elbow with internal treads on both ends to accommodate 1 ½” NPT aluminum pipes. Furnish the elbow with a minimum of 1 stainless steel set screw on each end of the elbow for securing the threaded nipple and support pipes.
- Nipple Pipe: 1 ½” \* 18” NPT long aluminum pipe, threaded on both ends.
- Support Pipe: 1 ½” \* 24” NPT long aluminum pipe, threaded on 1 end with an end cap.

### 21.3. CONSTRUCTION METHODS

#### A. General

**Perform a radio path Site Survey test before installing any equipment.** All radio path site surveys shall be completed during full foliage conditions. Ensure the test evaluates the Signal Strength (dBm), Fade Margin (dB), Signal-to-Noise Ratio, Data Integrity (poll test), and a complete frequency spectrum scan. Ensure the radio path site survey test is performed using the supplied brand of radio equipment to be deployed. During the initial radio path signal strength test it may be determined that a repeater station may be necessary to complete the intended link. Provide the test results to the Engineer for review and approval. Submit copies of the test results and colored copies of the frequency spectrum scan along with an electronic copy of this information. The Engineer will approve final locations of antennas and any necessary repeater stations. Install a coaxial cable – jumper with N-type connectors and additional antenna at locations where it is determined that a dual antenna configuration is necessary to accommodate communications in multiple directions.

Install the antenna in such a manner that avoids conflicts with other utilities (separation distances in accordance with the guidelines of the NESC) and as specified in the antenna manufacturer’s recommendations. Secure the antenna mounting hardware to the pole and route the coaxial cable such that no strain is placed on the N-Type Male coaxial connectors. On wood pole installations, bond the antenna mounting hardware to the pole ground using # 6 AWG bare copper wire using split bolt or compression type fitting.

Do not exceed the 1-inch bend radius of the coaxial cable as it traverses from the dual radio to the standalone antenna assembly. Properly ground and secure the arrestor in the cabinet. Permanently label all cables entering the cabinet. Ensure the POE injector for the radio system is **NOT** connected to the GFCI receptacle circuit located in the cabinet. Place a copy of all manufacturer equipment specifications and instruction and maintenance manuals in the equipment cabinet.

At certain locations it may be necessary to integrate the radio system with a fiber optic system. Follow the details shown in the fiber optic splice plans.

### 21.4. MEASUREMENT AND PAYMENT

*Wireless Ethernet Radio System* will be measured and paid for as the actual number of wireless radio systems furnished, installed and accepted.

This item includes the appropriate sized antennas, radios, power supplies and injectors, disconnect/snap switches, signs, decals, interface cabling, coaxial cabling, coaxial cable connectors, and labeling. Any integration between the wireless radio system and a fiber optic network, installation materials and configuration software necessary to complete this work, including the radio path Site Survey test and warranties, will be incidental.

Payment will be made under:

<b>Pay Item</b>	<b>Pay Unit</b>
Wireless Ethernet Radio System.....	Each

**22. SIGNAL CABINET FOUNDATIONS**

**22.1. DESCRIPTION**

Furnish and install signal cabinet foundations and all necessary hardware.

Furnish either poured concrete foundations or preformed cabinet pad foundations and all necessary hardware. Obtain approval of foundation type.

**22.2. MATERIAL**

Furnish preformed cabinet pad foundation material, equipment and hardware under this section that is pre-approved on the ITS and Signals QPL.

Refer to Articles 100-4 (Portland Cement Concrete) and 1098-15 (Signal Cabinet Foundation) of the Standard Specifications.

**22.3. CONSTRUCTION METHODS**

Install signal cabinet foundations in compliance with all requirements of Section 1750-3 of the Standard Specifications.

**22.4. MEASUREMENT AND PAYMENT**

*Signal Cabinet Foundation* will be measured and paid as the actual number furnished, installed and accepted.

Payment will be made under:

<b>Pay Item</b>	<b>Pay Unit</b>
Signal Cabinet Foundation.....	Each

## 23. CONTROLLERS WITH CABINETS

### 23.1. DESCRIPTION

Furnish and install controllers with cabinets and all necessary hardware. Furnish all pole or foundation mounting hardware, detector sensor cards, external electrical service disconnects, one Corbin Number 2 cabinet key, one police panel key, conflict monitors, surge protection, grounding systems, AC/DC isolator cards and all necessary hardware.

### 23.2. MATERIAL

#### A. General

Furnish material, equipment and hardware under this section that is pre-approved on the ITS and Signals QPL.

#### B. Type 2070E Controllers

Conform to CALTRANS *Transportation Electrical Equipment Specifications (TEES)* (dated March 12, 2009, plus Errata 1 dated January 21, 2010) except as required herein.

Furnish Model 2070E controllers. Ensure that removal of the CPU module from the controller will place the intersection into flash.

Provide Model 2070E controllers with the latest version of OS9 operating software and device drivers, composed of the unit chassis and at a minimum the following modules and assemblies:

- MODEL 2070-1E, CPU Module, Single Board, with 8Mb Datakey (blue in color)
- MODEL 2070-2A or approved MODEL 2070-2E, Field I/O Module (FI/O)
  - Note: Configure the Field I/O Module to disable both the External WDT Shunt/Toggle Switch and SP3 (SP3 active indicator is “off”)
- MODEL 2070-3B, Front Panel Module (FP), Display B (8x40)
- MODEL 2070-4, Power Supply Module, 10 AMP
- MODEL 2070-7A, Async Serial Com Module (9-pin RS-232)

#### C. General Cabinets

Provide a moisture resistant coating on all circuit boards.

Provide one 20 mm diameter radial lead UL-recognized metal oxide varistor (MOV) between each load switch field terminal and equipment ground. Electrical performance is outlined below.

<b>PROPERTIES OF MOV SURGE PROTECTOR</b>	
Maximum Continuous Applied Voltage at 185° F	150 VAC (RMS) 200 VDC
Maximum Peak 8x20µs Current at 185° F	6500 A
Maximum Energy Rating at 185° F	80 J
Voltage Range 1 mA DC Test at 77° F	212-268 V
Max. Clamping Voltage 8x20µs, 100A at 77° F	395 V
Typical Capacitance (1 MHz) at 77° F	1600 pF

Provide a power line surge protector that is a two-stage device that will allow connection of the radio frequency interference filter between the stages of the device. Ensure that a maximum continuous current is at least 10A at 120V. Ensure that the device can withstand a minimum of 20 peak surge current occurrences at 20,000A for an 8x20 microsecond waveform. Provide a maximum clamp voltage of 395V at 20,000A with a nominal series inductance of 200µh. Ensure that the voltage does not exceed 395V. Provide devices that comply with the following:

<b>Frequency (Hz)</b>	<b>Minimum Insertion Loss (dB)</b>
60	0
10,000	30
50,000	55
100,000	50
500,000	50
2,000,000	60
5,000,000	40
10,000,000	20
20,000,000	25

#### **D. Type 170E Cabinets**

##### **1. Type 170 E Cabinets General:**

Conform to the city of Los Angeles' Specification No. 54-053-08, *Traffic Signal Cabinet Assembly Specification* (dated July 2008), except as required herein.

Furnish model 336S pole mounted cabinets configured for 8 vehicle phases, 4 pedestrian phases, and 6 overlaps. Do not reassign load switches to accommodate overlaps unless shown on electrical details. Provide 336S pole mounted cabinets that are 46" high with 40" high internal rack assemblies.



Furnish model 332 base mounted cabinets configured for 8 vehicle phases, 4 pedestrian phases, and 6 overlaps. When overlaps are required, provide auxiliary output files for the overlaps. Do not reassign load switches to accommodate overlaps unless shown on electrical details.

Provide model 200 load switches, model 222 loop detector sensors, model 252 AC isolators, and model 242 DC isolators according to the electrical details. As a minimum, provide one (1) model 2018 conflict monitor, one (1) model 206L power supply unit, two (2) model 204 flashers, one (1) DC isolator (located in slot I14), and four (4) model 430 flash transfer relays (provide seven (7) model 430 flash transfer relays if auxiliary output file is installed) with each cabinet.

**2. Type 170 E Cabinet Electrical Requirements:**

Provide a cabinet assembly designed to ensure that upon leaving any cabinet switch or conflict monitor initiated flashing operation, the controller starts up in the programmed start up phases and start up interval.

Furnish two sets of non-fading cabinet wiring diagrams and schematics in a paper envelope or container and placed in the cabinet drawer.

All AC+ power is subject to radio frequency signal suppression.

Provide surge suppression in the cabinet for each type of cabinet device. Provide surge protection for the full capacity of the cabinet input file. Provide surge suppression devices that operate properly over a temperature range of -40° F to +185° F. Ensure the surge suppression devices provide both common and differential modes of protection.

Provide a pluggable power line surge protector that is installed on the back of the PDA (power distribution assembly) chassis to filter and absorb power line noise and switching transients. Ensure the device incorporates LEDs for failure indication and provides a dry relay contact closure for the purpose of remote sensing. Ensure the device meets the following specifications:

- Peak Surge Current (Single pulse, 8x20µs).....20,000A
- Occurrences (8x20µs waveform).....10 minimum @ 20,000A
- Maximum Clamp Voltage.....395VAC
- Operating Current.....15 amps
- Response Time.....< 5 nanoseconds

Provide a loop surge suppressor for each set of loop terminals in the cabinet. Ensure the device meets the following specifications:

- Peak Surge Current (6 times, 8x20µs)
  - (Differential Mode).....400A
  - (Common Mode).....1,000A
- Occurrences (8x20µs waveform).....500 min @ 200A
- Maximum Clamp Voltage
  - (Differential Mode @400A).....35V
  - (Common Mode @1,000A).....35V

Response Time.....< 5 nanoseconds  
 Maximum Capacitance.....35 pF

Provide a data communications surge suppressor for each communications line entering or leaving the cabinet. Ensure the device meets the following specifications:

Peak Surge Current (Single pulse, 8x20 $\mu$ s).....10,000A  
 Occurrences (8x20 $\mu$ s waveform).....100 min @ 2,000A  
 Maximum Clamp Voltage.....Rated for equipment protected  
 Response Time.....< 1 nanosecond  
 Maximum Capacitance.....1,500 pF  
 Maximum Series Resistance.....15 $\Omega$

Provide a DC signal surge suppressor for each DC input channel in the cabinet. Ensure the device meets the following specifications:

Peak Surge Current (Single pulse, 8x20 $\mu$ s).....10,000A  
 Occurrences (8x20 $\mu$ s waveform).....100 @ 2,000A  
 Maximum Clamp Voltage.....30V  
 Response Time.....< 1 nanosecond

Provide a 120 VAC signal surge suppressor for each AC+ interconnect signal input. Ensure the device meets the following specifications:

Peak Surge Current (Single pulse, 8x20 $\mu$ s).....20,000A  
 Maximum Clamp Voltage.....350VAC  
 Response Time.....< 200 nanoseconds  
 Discharge Voltage.....<200 Volts @ 1,000A  
 Insulation Resistance..... $\geq$ 100 M $\Omega$

Provide conductors for surge protection wiring that are of sufficient size (ampacity) to withstand maximum overcurrents which could occur before protective device thresholds are attained and current flow is interrupted.

If additional surge protected power outlets are needed to accommodate fiber transceivers, modems, etc., install a UL listed, industrial, heavy-duty type power outlet strip with a minimum rating of 15 A / 125 VAC, 60 Hz. Provide a strip that has a minimum of 3 grounded outlets. Ensure the power outlet strip plugs into one of the controller unit receptacles located on the rear of the PDA. Ensure power outlet strip is mounted securely; provide strain relief if necessary.

Provide a door switch in the front and a door switch in the rear of the cabinet that will provide the controller unit with a Door Ajar alarm when either the front or the rear door is open. Ensure the door switches apply DC ground to the Input File when either the front door or the rear door is open.

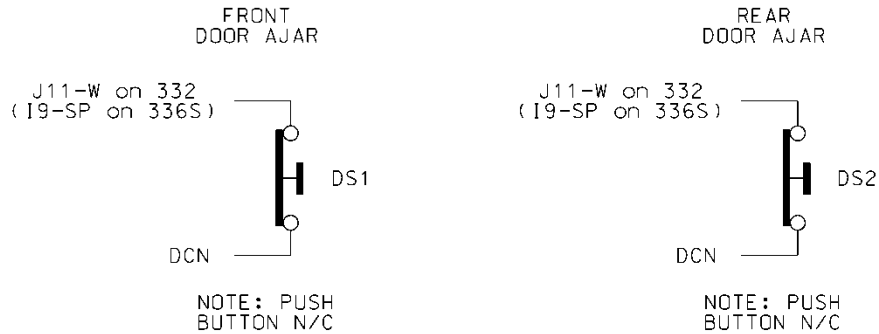

Furnish a fluorescent fixture in the rear across the top of the cabinet and another fluorescent fixture in the front across the top of the cabinet at a minimum. Ensure that the fixtures provide sufficient light to illuminate all terminals, labels, switches, and devices in the cabinet. Conveniently locate the fixtures so as not to interfere with a technician's ability to perform work on any devices or terminals in the cabinet. Provide a protective diffuser to cover exposed bulbs. Install 16 watt T-4 lamps in the fluorescent fixtures. Provide a door switch to provide power to each fixture when the respective door is open. Wire the fluorescent fixtures to the 15 amp ECB (equipment circuit breaker).

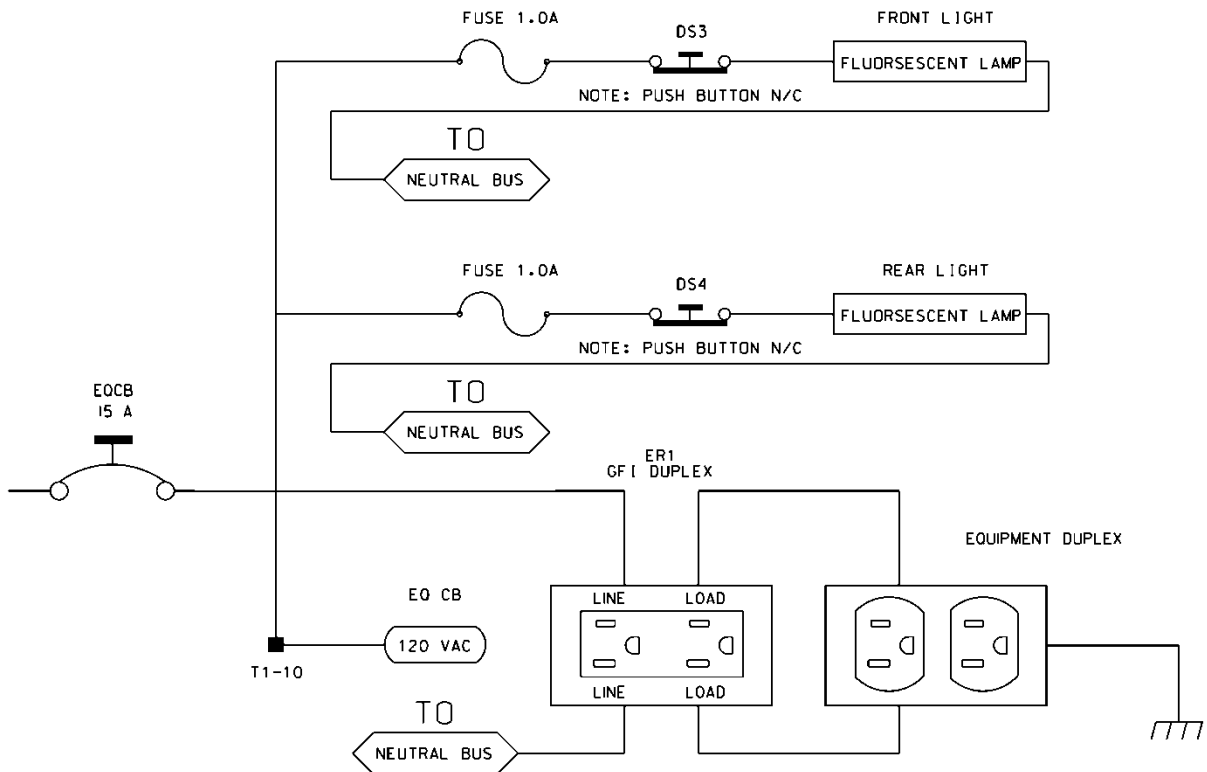

Furnish a police panel with a police panel door. For model 336S cabinets, mount the police panel on the rear door. Ensure that the police panel door permits access to the police panel when the main door is closed. Ensure that no rainwater can enter the cabinet even with the police panel door open. Provide a police panel door hinged on the right side as viewed from the front. Provide a police panel door lock that is keyed to a standard police/fire call box key. In addition to the requirements of LA Specification No. 54-053-08, provide the police panel with a toggle switch connected to switch the intersection operation between normal stop-and-go operation (AUTO) and manual operation (MANUAL). Ensure that manual control can be implemented using inputs and software such that the controller provides full programmed clearance times for the yellow clearance and red clearance for each phase while under manual control.

Provide a 1/4-inch locking phone jack in the police panel for a hand control to manually control the intersection. Provide sufficient room in the police panel for storage of a hand control and cord.

Ensure the 336S cabinet Input File is wired as follows:

<b>336S Cabinet</b>														
<b>Port-Bit/C-1 Pin Assignment</b>														
Slot #	1	2	3	4	5	6	7	8	9	10	11	12	13	14
C-1 (Spares)	59	60	61	62	63	64	65	66	75	76	77	78	79	80
Port C-1	3-2 56	1-1 39	3-4 58	1-3 41	3-1 55	1-2 40	3-3 57	1-4 42	2-5 51	5-5 71	5-6 72	5-1 67	5-2 68	6-7 81
Port C-1	2-1 47	1-5 43	2-3 49	1-7 45	2-2 48	1-6 44	2-4 50	1-8 46	2-6 52	5-7 73	5-8 74	5-3 69	5-4 70	6-8 82

For model 332 base mounted cabinets, ensure terminals J14-E and J14-K are wired together on the rear of the Input File. Connect TB9-12 (J14 Common) on the Input Panel to T1-2 (AC-) on the rear of the PDA.

Provide detector test switches mounted at the top of the cabinet rack or other convenient location which may be used to place a call on each of eight phases based on the chart below. Provide three positions for each switch: On (place call), Off (normal detector operation), and Momentary On (place momentary call and return to normal detector operation after switch is released). Ensure that the switches are located such that the technician can read the controller display and observe the intersection.

Connect detector test switches for cabinets as follows:

336S Cabinet		332 Cabinet	
Detector Call Switches	Terminals	Detector Call Switches	Terminals
Phase 1	I1-F	Phase 1	I1-W
Phase 2	I2-F	Phase 2	I4-W
Phase 3	I3-F	Phase 3	I5-W
Phase 4	I4-F	Phase 4	I8-W
Phase 5	I5-F	Phase 5	J1-W
Phase 6	I6-F	Phase 6	J4-W
Phase 7	I7-F	Phase 7	J5-W
Phase 8	I8-F	Phase 8	J8-W

Provide the PCB 28/56 connector for the conflict monitor unit (CMU) with 28 independent contacts per side, dual-sided with 0.156 inch contact centers. Provide the PCB 28/56 connector contacts with solder eyelet terminations. Ensure all connections to the PCB 28/56 connector are soldered to the solder eyelet terminations.

Ensure that all cabinets have the CMU connector wired according to the 332 cabinet connector pin assignments (include all wires for auxiliary output file connection). Wire pins 13, 16, R, and U of the CMU connector to a separate 4 pin plug, P1, as shown below. Provide a second plug, P2, which will mate with P1 and is wired to the auxiliary output file as shown below. Provide an additional plug, P3, which will mate with P1 and is wired to the pedestrian yellow circuits as shown below. When no auxiliary output file is installed in the cabinet, provide wires for the green and yellow inputs for channels 11, 12, 17, and 18, the red inputs for channels 17 and 18, and the wires for the P2 plug. Terminate the two-foot wires with ring type lugs, insulated, and bundled for optional use.

PIN	P1		P2		P3	
	FUNCTION	CONN TO	FUNCTION	CONN TO	FUNCTION	CONN TO
1	CH-9G	CMU-13	OLA-GRN	A123	2P-YEL	114
2	CH-9Y	CMU-16	OLA-YEL	A122	4P-YEL	105
3	CH-10G	CMU-R	OLB-GRN	A126	6P-YEL	120
4	CH-10Y	CMU-U	OLB-YEL	A125	8P-YEL	111

Do not provide the P20 terminal assembly (red monitor board) or red interface ribbon cable as specified in LA Specification No. 54-053-08.

Provide a P20 connector that mates with and is compatible with the red interface connector mounted on the front of the conflict monitor. Ensure that the P20 connector and the red interface connector on the conflict monitor are center polarized to ensure proper connection. Ensure that

removal of the P20 connector will cause the conflict monitor to recognize a latching fault condition and place the cabinet into flashing operation.

Wire the P20 connector to the output file and auxiliary output file using 22 AWG stranded wires. Ensure the length of these wires is a minimum of 42 inches in length. Provide a durable braided sleeve around the wires to organize and protect the wires.

Wire the P20 connector to the traffic signal red displays to provide inputs to the conflict monitor as shown below. Ensure the pedestrian Don't Walk circuits are wired to channels 13 through 16 of the P20 connector. When no auxiliary output file is installed in the cabinet, provide wires for channels 9 through 12 reds. Provide a wire for special function 1. Terminate the unused wires with ring type lugs, insulated, and bundled for optional use.

P20 Connector					
PIN	FUNCTION	CONN TO	PIN	FUNCTION	CONN TO
1	Channel 15 Red	119	2	Channel 16 Red	110
3	Channel 14 Red	104	4	Chassis GND	01-9
5	Channel 13 Red	113	6	N/C	
7	Channel 12 Red	AUX 101	8	Spec Function 1	
9	Channel 10 Red	AUX 124	10	Channel 11 Red	AUX 114
11	Channel 9 Red	AUX 121	12	Channel 8 Red	107
13	Channel 7 Red	122	14	Channel 6 Red	134
15	Channel 5 Red	131	16	Channel 4 Red	101
17	Channel 3 Red	116	18	Channel 2 Red	128
19	Channel 1 Red	125	20	Red Enable	01-14

Ensure the controller unit outputs to the auxiliary output file are pre-wired to the C5 connector. When no auxiliary output file is installed in the cabinet, connect the C5 connector to a storage socket located on the Input Panel or on the rear of the PDA.

Do not wire pin 12 of the load switch sockets.

In addition to the requirements of LA Specification No. 54-053-08, ensure relay K1 on the Power Distribution Assembly (PDA) is a four pole relay and K2 on the PDA is a two pole relay.

Provide a two pole, ganged circuit breaker for the flash bus circuit. Ensure the flash bus circuit breaker is an inverse time circuit breaker rated for 10 amps at 120 VAC with a minimum of 10,000 RMS symmetrical amperes short circuit current rating. Do not provide the auxiliary switch feature on the flash bus circuit breaker. Ensure the ganged flash bus circuit breaker is certified by the circuit breaker manufacturer to provide gang tripping operation.

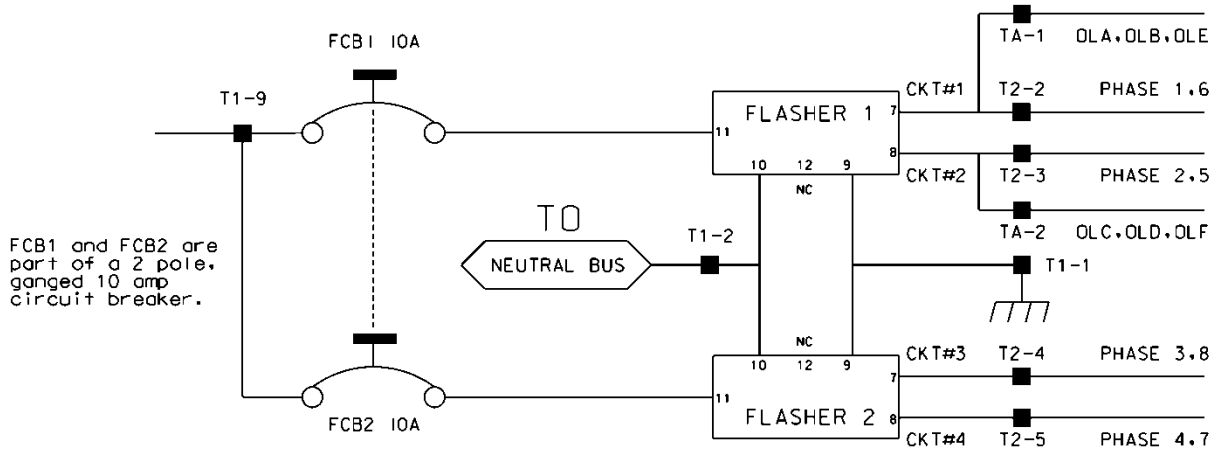

Ensure auxiliary output files are wired as follows:

<b>AUXILIARY OUTPUT FILE</b>	
<b>TERMINAL BLOCK TA ASSIGNMENTS</b>	
<b>POSITION</b>	<b>FUNCTION</b>
1	Flasher Unit #1, Circuit 1/FTR1 (OLA, OLB)/FTR3 (OLE)
2	Flasher Unit #1, Circuit 2/FTR2 (OLC, OLD)/FTR3 (OLF)
3	Flash Transfer Relay Coils
4	AC -
5	Power Circuit 5
6	Power Circuit 5
7	Equipment Ground Bus
8	NC

Provide four spare load resistors mounted in each cabinet. Ensure each load resistor is rated as shown in the table below. Wire one side of each load resistor to AC-. Connect the other side of each resistor to a separate terminal on a four (4) position terminal block. Mount the load resistors and terminal block either inside the back of Output File No. 1 or on the upper area of the Service Panel.

ACCEPTABLE LOAD RESISTOR VALUES	
VALUE (ohms)	WATTAGE
1.5K – 1.9 K	25W (min)
2.0K – 3.0K	10W (min)

Provide Model 200 load switches, Model 204 flashers, Model 242 DC isolators, Model 252 AC isolators, and Model 206L power supply units that conform to CALTRANS' *Transportation Electrical Equipment Specifications* dated March 12, 2009 with Erratum 1.

### 3. Type 170 E Cabinet Physical Requirements:

Do not mold, cast, or scribe the name "City of Los Angeles" on the outside of the cabinet door as specified in LA Specification No. 54-053-08. Do not provide a Communications Terminal Panel as specified in LA Specification No. 54-053-08. Do not provide terminal block TBB on the Service Panel. Do not provide Cabinet Verification Test Program software or associated test jigs as specified in LA Specification No. 54-053-08.

Furnish unpainted, natural, aluminum cabinet shells. Ensure that all non-aluminum hardware on the cabinet is stainless steel or a Department approved non-corrosive alternate.

Ensure the lifting eyes, gasket channels, police panel, and all supports welded to the enclosure and doors are fabricated from 0.125 inch minimum thickness aluminum sheet and meet the same standards as the cabinet and doors.

Provide front and rear doors with latching handles that allow padlocking in the closed position. Furnish 0.75 inch minimum diameter stainless steel handles with a minimum 0.5 inch shank. Place the padlocking attachment at 4.0 inches from the handle shank center to clear the lock and key. Provide an additional 4.0 inches minimum gripping length.

Provide Corbin #2 locks on the front and rear doors. Provide one (1) Corbin #2 and one (1) police master key with each cabinet. Ensure main door locks allow removal of keys in the locked position only.

Provide a surge protection panel with 16 loop surge protection devices and designed to allow sufficient free space for wire connection/disconnection and surge protection device replacement. For model 332 cabinets, provide an additional 20 loop surge protection devices. Provide an additional two AC+ interconnect surge devices to protect one slot and eight DC surge protection devices to protect four slots. Provide no protection devices on slot I14.

For pole mounted cabinets, mount surge protection devices for the AC+ interconnect inputs, inductive loop detector inputs, and low voltage DC inputs on a swing down panel assembly fabricated from sturdy aluminum. Attach the swing down panel to the bottom rear cabinet rack assembly using thumb screws. Ensure the swing down panel allows for easy removal of the input file without removing the surge protection panel assembly or its parts. Have the surge protection devices mounted horizontally on the panel and soldered to the feed through terminals of four 14 position terminal blocks with #8 screws mounted on the other side. Ensure the top row of terminals is connected to the upper slots and the bottom row of terminals is connected to the bottom slots. Provide a 15 position copper equipment ground bus attached to the field terminal side (outside) of



the swing down panel for termination of loop lead-in shield grounds. Ensure that a Number 4 AWG green wire connects the surge protection panel assembly ground bus to the main cabinet equipment ground.

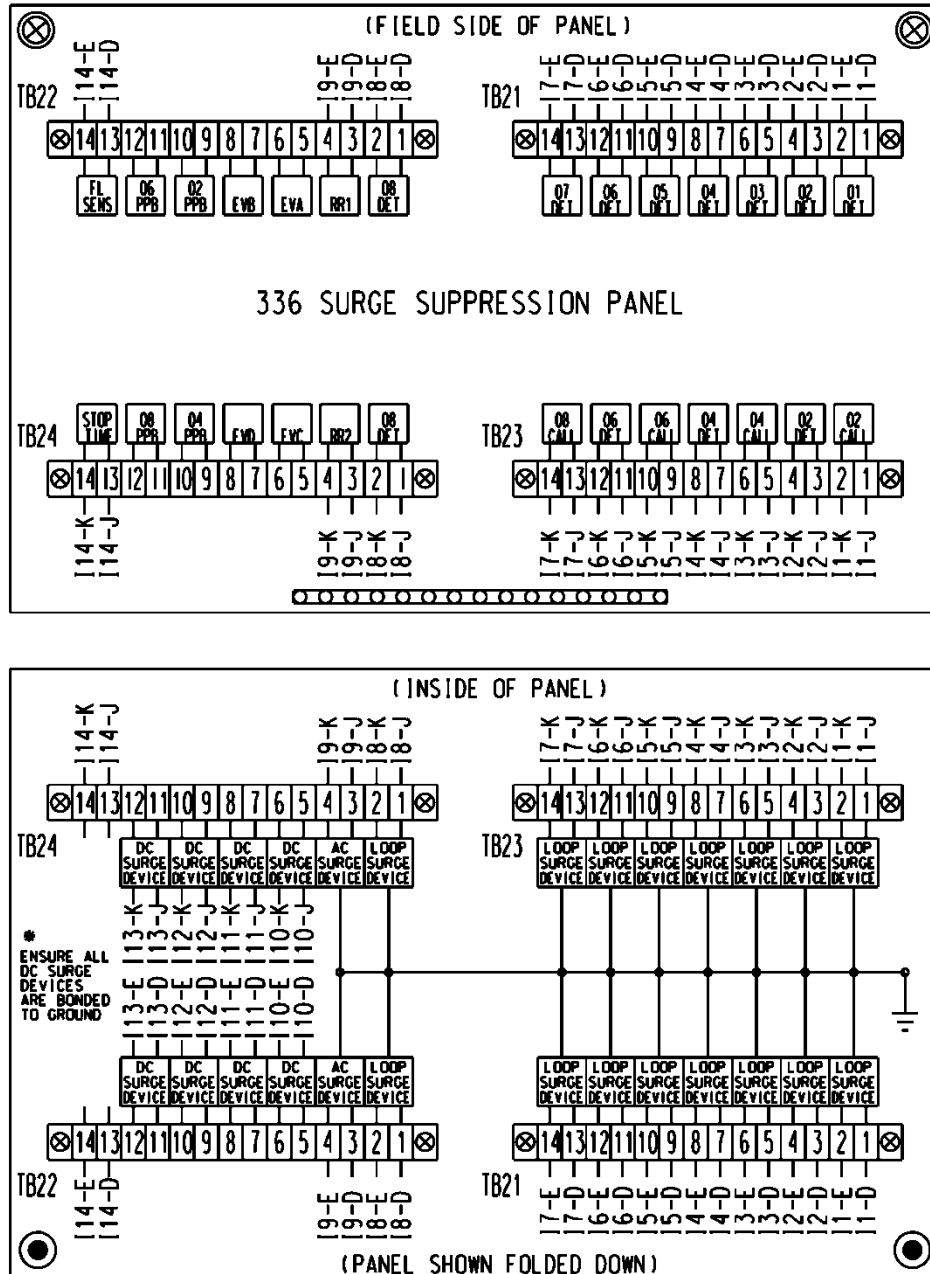

For base mounted cabinets, mount surge protection panels on the left side of the cabinet as viewed from the rear. Attach each panel to the cabinet rack assembly using bolts and make it easily removable. Mount the surge protection devices in vertical rows on each panel and connect the devices to one side of 12 position, double row terminal blocks with #8 screws. For each surge protection panel, terminate all grounds from the surge protection devices on a copper equipment

ground bus attached to the surge protection panel. Wire the terminals to the rear of a standard input file using spade lugs for input file protection.

Provide permanent labels that indicate the slot and the pins connected to each terminal that may be viewed from the rear cabinet door. Label and orient terminals so that each pair of inputs is next to each other. Indicate on the labeling the input file (I or J), the slot number (1-14) and the terminal pins of the input slots (either D & E for upper or J & K for lower).

Provide a minimum 14 x 16 inch pull out, hinged top shelf located immediately below controller mounting section of the cabinet. Ensure the shelf is designed to fully expose the table surface outside the controller at a height approximately even with the bottom of the controller. Ensure the shelf has a storage bin interior which is a minimum of 1 inch deep and approximately the same dimensions as the shelf. Provide an access to the storage area by lifting the hinged top of the shelf. Fabricate the shelf and slide from aluminum or stainless steel and ensure the assembly can support the 2070L controller plus 15 pounds of additional weight. Ensure shelf has a locking mechanism to secure it in the fully extended position and does not inhibit the removal of the 2070L controller or removal of cards inside the controller when fully extended. Provide a locking mechanism that is easily released when the shelf is to be returned to its non-use position directly under the controller.

#### **4. Model 2018 Enhanced Conflict Monitor:**

Furnish Model 2018 Enhanced Conflict Monitors that provide monitoring of 18 channels. Ensure each channel consists of a green, yellow, and red field signal input. Ensure that the conflict monitor meets or exceeds CALTRANS' Transportation Electrical Equipment Specifications dated March 12, 2009, with Erratum 1 (hereafter referred to as CALTRANS' 2009 TEES) for a model 210 monitor unit and other requirements stated in this specification.

Ensure the conflict monitor is provided with an 18 channel conflict programming card. Pin EE and Pin T of the conflict programming card shall be connected together. Pin 16 of the conflict programming card shall be floating. Ensure that the absence of the conflict programming card will cause the conflict monitor to trigger (enter into fault mode), and remain in the triggered state until the programming card is properly inserted and the conflict monitor is reset.

Provide a conflict monitor that incorporates LED indicators into the front panel to dynamically display the status of the monitor under normal conditions and to provide a comprehensive review of field inputs with monitor status under fault conditions. Ensure that the monitor indicates the channels that were active during a conflict condition and the channels that experienced a failure for all other per channel fault conditions detected. Ensure that these indications and the status of each channel are retained until the Conflict Monitor is reset. Furnish LED indicators for the following:

- AC Power (Green LED indicator)
- VDC Failed (Red LED indicator)
- WDT Error (Red LED indicator)
- Conflict (Red LED indicator)
- Red Fail (Red LED indicator)
- Dual Indication (Red LED indicator)
- Yellow/Clearance Failure (Red LED indicator)

- PCA/PC Ajar (Red LED indicator)
- Monitor Fail/Diagnostic Failure (Red LED indicator)
- 54 Channel Status Indicators (1 Red, 1 Yellow, and 1 Green LED indicator for each of the 18 channels)

Provide a switch to set the Red Fail fault timing. Ensure that when the switch is in the ON position the Red Fail fault timing value is set to 1350 +/- 150 ms (2018 mode). Ensure that when the switch is in the OFF position the Red Fail fault timing value is set to 850 +/- 150 ms (210 mode).

Provide a switch to set the Watchdog fault timing. Ensure that when the switch is in the ON position the Watchdog fault timing value is set to 1.0 +/- 0.1 s (2018 mode). Ensure that when the switch is in the OFF position the Watchdog fault timing value is set to 1.5 +/- 0.1 s (210 mode).

Provide a jumper or switch to set the AC line brown-out levels. Ensure that when the jumper is present or the switch is in the ON position the AC line dropout voltage threshold is 98 +/- 2 Vrms, the AC line restore voltage threshold is 103 +/- 2 Vrms, and the AC line brown-out timing value is set to 400 +/- 50ms (2018 mode). Ensure that when the jumper is not present or the switch is in the OFF position the AC line dropout voltage threshold is 92 +/- 2 Vrms, the AC line restore voltage threshold is 98 +/- 2 Vrms, and the AC line brown-out timing value is set to 80 +/- 17 ms (210 mode).

Provide a jumper or switch that will enable and disable the Watchdog Latch function. Ensure that when the jumper is not present or the switch is in the OFF position the Watchdog Latch function is disabled. In this mode of operation, a Watchdog fault will be reset following a power loss, brownout, or power interruption. Ensure that when the jumper is present or the switch is in the ON position the Watchdog Latch function is enabled. In this mode of operation, a Watchdog fault will be retained until a Reset command is issued.

Provide a jumper that will reverse the active polarity for pin #EE (output relay common). Ensure that when the jumper is not present pin #EE (output relay common) will be considered 'Active' at a voltage greater than 70 Vrms and 'Not Active' at a voltage less than 50 Vrms (Caltrans mode). Ensure that when the jumper is present pin #EE (output relay common) will be considered 'Active' at a voltage less than 50 Vrms and 'Not Active' at a voltage greater than 70 Vrms (Failsafe mode).

In addition to the connectors required by CALTRANS' 2009 TEES, provide the conflict monitor with a red interface connector mounted on the front of the monitor. Ensure the connector is a 20 pin, right angle, center polarized, male connector with latching clip locks and polarizing keys. Ensure the right angle solder tails are designed for a 0.062" thick printed circuit board. Keying of the connector shall be between pins 3 and 5, and between 17 and 19. Ensure the connector has two rows of pins with the odd numbered pins on one row and the even pins on the other row. Ensure the connector pin row spacing is 0.10" and pitch is 0.10". Ensure the mating length of the connector pins is 0.24". Ensure the pins are finished with gold plating 30μ" thick.

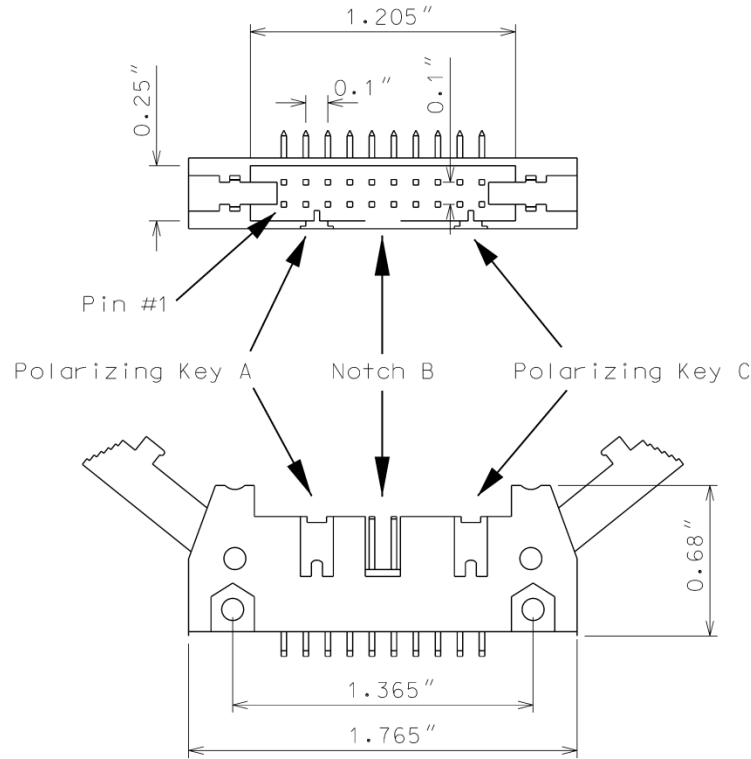

Ensure the red interface connector pins on the monitor have the following functions:

Pin #	Function	Pin #	Function
1	Channel 15 Red	2	Channel 16 Red
3	Channel 14 Red	4	Chassis Ground
5	Channel 13 Red	6	Special Function 2
7	Channel 12 Red	8	Special Function 1
9	Channel 10 Red	10	Channel 11 Red
11	Channel 9 Red	12	Channel 8 Red
13	Channel 7 Red	14	Channel 6 Red
15	Channel 5 Red	16	Channel 4 Red
17	Channel 3 Red	18	Channel 2 Red
19	Channel 1 Red	20	Red Enable

Ensure that removal of the P20 cable connector will cause the conflict monitor to recognize a latching fault condition and place the cabinet into flashing operation.

Provide Special Function 1 and Special Function 2 inputs to the unit which shall disable only Red Fail Monitoring when either input is sensed active. A Special Function input shall be sensed active

when the input voltage exceeds 70 Vrms with a minimum duration of 550 ms. A Special Function input shall be sensed not active when the input voltage is less than 50 Vrms or the duration is less than 250 ms. A Special Function input is undefined by these specifications and may or may not be sensed active when the input voltage is between 50 Vrms and 70 Vrms or the duration is between 250 ms and 550 ms.

Ensure the conflict monitor recognizes field signal inputs for each channel that meet the following requirements:

- consider a Red input greater than 70 Vrms and with a duration of at least 500 ms as an “on” condition;
- consider a Red input less than 50 Vrms or with a duration of less than 200 ms as an “off” condition (no valid signal);
- consider a Red input between 50 Vrms and 70 Vrms or with a duration between 200 ms and 500 ms to be undefined by these specifications;
- consider a Green or Yellow input greater than 25 Vrms and with a duration of at least 500 ms as an “on” condition;
- consider a Green or Yellow input less than 15 Vrms or with a duration of less than 200 ms as an “off” condition; and
- consider a Green or Yellow input between 15 Vrms and 25 Vrms or with a duration between 200 ms and 500 ms to be undefined by these specifications.

Provide a conflict monitor that recognizes the faults specified by CALTRANS’ 2009 TEES and the following additional faults. Ensure the conflict monitor will trigger upon detection of a fault and will remain in the triggered (in fault mode) state until the unit is reset at the front panel or through the external remote reset input for the following failures:

1. **Red Monitoring or Absence of Any Indication (Red Failure):** A condition in which no “on” voltage signal is detected on any of the green, yellow, or red inputs to a given monitor channel. If a signal is not detected on at least one input (R, Y, or G) of a conflict monitor channel for a period greater than 1000 ms when used with a 170 controller and 1500 ms when used with a 2070 controller, ensure monitor will trigger and put the intersection into flash. If the absence of any indication condition lasts less than 700 ms when used with a 170 controller and 1200 ms when used with a 2070 controller, ensure conflict monitor will not trigger. Red fail monitoring shall be enabled on a per channel basis by the use of switches located on the conflict monitor. Have red monitoring occur when all of the following input conditions are in effect:
  - a) Red Enable input to monitor is active (Red Enable voltages are “on” at greater than 70 Vrms, off at less than 50 Vrms, undefined between 50 and 70 Vrms), and
  - b) Neither Special Function 1 nor Special Function 2 inputs are active.
  - c) Pin #EE (output relay common) is not active

2. **Short/Missing Yellow Indication Fault (Clearance Error):** Yellow indication following a green is missing or shorter than 2.7 seconds (with  $\pm 0.1$ -second accuracy). If a channel fails to detect an “on” signal at the Yellow input for a minimum of 2.7 seconds ( $\pm 0.1$  second) following the detection of an “on” signal at a Green input for that channel, ensure that the monitor triggers and generates a clearance/short yellow error fault indication. Short/missing yellow (clearance) monitoring shall be enabled on a per channel basis by the use of switches located on the conflict monitor. This fault shall not occur when the channel is programmed for Yellow Inhibit, when the Red Enable signal is inactive or pin #EE (output relay common) is active.
3. **Dual Indications on the Same Channel:** In this condition, more than one indication (R,Y,G) is detected as “on” at the same time on the same channel. If dual indications are detected for a period greater than 500 ms, ensure that the conflict monitor triggers and displays the proper failure indication (Dual Ind fault). If this condition is detected for less than 200 ms, ensure that the monitor does not trigger. G-Y-R dual indication monitoring shall be enabled on a per channel basis by the use of switches located on the conflict monitor. G-Y dual indication monitoring shall be enabled for all channels by use of a switch located on the conflict monitor. This fault shall not occur when the Red Enable signal is inactive or pin #EE (output relay common) is active.
4. **Configuration Settings Change:** The configuration settings are comprised of (as a minimum) the permissive diode matrix, dual indication switches, yellow disable jumpers, any option switches, any option jumpers, and the Watchdog Enable switch. Ensure the conflict monitor compares the current configuration settings with the previous stored configuration settings on power-up, on reset, and periodically during operation. If any of the configuration settings are changed, ensure that the conflict monitor triggers and causes the program card indicator to flash. Ensure that configuration change faults are only reset by depressing and holding the front panel reset button for a minimum of three seconds. Ensure the external remote reset input does not reset configuration change faults.

Ensure the conflict monitor will trigger and the AC Power indicator will flash at a rate of  $2 \text{ Hz} \pm 20\%$  with a 50% duty cycle when the AC Line voltage falls below the “drop-out” level. Ensure the conflict monitor will resume normal operation when the AC Line voltage returns above the “restore” level. Ensure the AC Power indicator will remain illuminated when the AC voltage returns above the “restore” level. Should an AC Line power interruption occur while the monitor is in the fault mode, then upon restoration of AC Line power, the monitor will remain in the fault mode and the correct fault and channel indicators will be displayed.

Provide a flash interval of at least 6 seconds and at most 10 seconds in duration following a power-up, an AC Line interruption, or a brownout restore. Ensure the conflict monitor will suspend all fault monitoring functions, close the Output relay contacts, and flash the AC indicator at a rate of  $4 \text{ Hz} \pm 20\%$  with a 50% duty cycle during this interval. Ensure the termination of the flash interval after at least 6 seconds if the Watchdog input has made 5 transitions between the True and False state and the AC Line voltage is greater than the “restore” level. If the watchdog input has not made

5 transitions between the True and False state within  $10 \pm 0.5$  seconds, the monitor shall enter a WDT error fault condition.

Ensure the conflict monitor will monitor an intersection with a minimum of four approaches using the four-section Flashing Yellow Arrow (FYA) vehicle traffic signal as outlined by the NCHRP 3-54 research project for protected-permissive left turn signal displays. Ensure the conflict monitor will operate in the FYA mode and FYAc (Compact) mode as specified below to monitor each channel pair for the following fault conditions: Conflict, Flash Rate Detection, Red Fail, Dual Indication, and Clearance. Provide a switch to select between the FYA mode and FYAc mode. Provide a switch to select each FYA phase movement for monitoring.

#### FYA mode

FYA Signal Head	Phase 1	Phase 3	Phase 5	Phase 7
Red Arrow	Channel 9 Red	Channel 10 Red	Channel 11 Red	Channel 12 Red
Yellow Arrow	Channel 9 Yellow	Channel 10 Yellow	Channel 11 Yellow	Channel 12 Yellow
Flashing Yellow Arrow	Channel 9 Green	Channel 10 Green	Channel 11 Green	Channel 12 Green
Green Arrow	Channel 1 Green	Channel 3 Green	Channel 5 Green	Channel 7 Green

#### FYAc mode

FYA Signal Head	Phase 1	Phase 3	Phase 5	Phase 7
Red Arrow	Channel 1 Red	Channel 3 Red	Channel 5 Red	Channel 7 Red
Yellow Arrow	Channel 1 Yellow	Channel 3 Yellow	Channel 5 Yellow	Channel 7 Yellow
Flashing Yellow Arrow	Channel 1 Green	Channel 3 Green	Channel 5 Green	Channel 7 Green
Green Arrow	Channel 9 Green	Channel 9 Yellow	Channel 10 Green	Channel 10 Yellow

If a FYA channel pair is enabled for FYA operation, the conflict monitor will monitor the FYA logical channel pair for the additional following conditions:

1. **Conflict:** Channel conflicts are detected based on the permissive programming jumpers on the program card. This operation remains unchanged from normal operation except for the solid Yellow arrow (FYA clearance) signal.
2. **Yellow Change Interval Conflict:** During the Yellow change interval of the Permissive Turn channel (flashing Yellow arrow) the conflict monitor shall verify that no conflicting channels to the solid Yellow arrow channel (clearance) are active. These conflicting channels shall be determined by the program card compatibility programming of the Permissive Turn channel (flashing Yellow arrow). During the Yellow change interval of the Protected Turn channel (solid Green arrow) the conflict monitor shall verify that no conflicting channels to the solid Yellow arrow channel (clearance) are active as determined by the program card compatibility programming of the Protected Turn channel (solid Green arrow).
3. **Flash Rate Detection:** The conflict monitor unit shall monitor for the absence of a valid flash rate for the Permissive turn channel (flashing Yellow arrow). If the Permissive turn channel (flashing Yellow arrow) is active for a period greater than 1600 milliseconds, ensure the conflict monitor triggers and puts the intersection into flash. If the Permissive turn channel (flashing Yellow arrow) is active for a period less than 1400 milliseconds, ensure the conflict monitor does not trigger. Ensure the conflict monitor will remain in the triggered (in fault mode) state until the unit is reset at the front panel or through the external remote reset input. Provide a jumper or switch that will enable and disable the Flash Rate Detection function. Ensure that when the jumper is not present or the switch is in the OFF position the Flash Rate Detection function is enabled. Ensure that when the jumper is present or the switch is in the ON position the Flash Rate Detection function is disabled.
4. **Red Monitoring or Absence of Any Indication (Red Failure):** The conflict monitor unit shall detect a red failure if there is an absence of voltage on all four of the inputs of a FYA channel pair (RA, YA, FYA, GA).
5. **Dual Indications on the Same Channel:** The conflict monitor unit shall detect a dual indication if two or more inputs of a FYA channel pair (RA, YA, FYA, GA) are “on” at the same time.
6. **Short/Missing Yellow Indication Fault (Clearance Error):** The conflict monitor unit shall monitor the solid Yellow arrow for a clearance fault when terminating both the Protected Turn channel (solid Green arrow) interval and the Permissive Turn channel (flashing Yellow arrow) interval.

Ensure that the conflict monitor will log at least nine of the most recent events detected by the monitor in non-volatile EEPROM memory (or equivalent). For each event, record at a minimum the time, date, type of event, status of each field signal indication with RMS voltage, and specific channels involved with the event. Ensure the conflict monitor will log the following events: monitor reset, configuration, previous fault, and AC line. Furnish the signal sequence log that shows all channel states (Greens, Yellows, and Reds) and the Red Enable State for a minimum of 2 seconds prior to the current fault trigger point. Ensure the display resolution of the inputs for the signal sequence log is not greater than 50 ms.

For conflict monitors used within an Ethernet communications system, provide a conflict monitor with an Ethernet 10/100 Mbps, RJ-45 port for data communication access to the monitor by a local notebook computer and remotely via a workstation or notebook computer device connected



to the signal system local area network. The Ethernet port shall be electrically isolated from the conflict monitor's electronics and shall provide a minimum of 1500 Vrms isolation. Integrate monitor with Ethernet network in cabinet. Provide software to retrieve the time and date from a network server in order to synchronize the on-board times between the conflict monitor and the controller. Furnish and install the following Windows based, graphic user interface software on workstations and notebook computers where the signal system client software is installed: 1) software to view and retrieve all event log information, 2) software that will search and display a list of conflict monitor IP addresses and IDs on the network, and 3) software to change the conflict monitor's network parameters such as IP address and subnet mask.

---

**MONITOR BOARD EDGE CONNECTOR**

---

<b>Pin #</b>	<b>Function (Back Side)</b>	<b>Pin #</b>	<b>Function (Component Side)</b>
1	Channel 2 Green	A	Channel 2 Yellow
2	Channel 13 Green	B	Channel 6 Green
3	Channel 6 Yellow	C	Channel 15 Green
4	Channel 4 Green	D	Channel 4 Yellow
5	Channel 14 Green	E	Channel 8 Green
6	Channel 8 Yellow	F	Channel 16 Green
7	Channel 5 Green	H	Channel 5 Yellow
8	Channel 13 Yellow	J	Channel 1 Green
9	Channel 1 Yellow	K	Channel 15 Yellow
10	Channel 7 Green	L	Channel 7 Yellow
11	Channel 14 Yellow	M	Channel 3 Green
12	Channel 3 Yellow	N	Channel 16 Yellow
13	Channel 9 Green	P	Channel 17 Yellow
14	Channel 17 Green	R	Channel 10 Green
15	Channel 11 Yellow	S	Channel 11 Green
16	Channel 9 Yellow	T	Channel 18 Yellow
17	Channel 18 Green	U	Channel 10 Yellow
--		--	
18	Channel 12 Yellow	V	Channel 12 Green
19	Channel 17 Red	W	Channel 18 Red
20	Chassis Ground	X	Not Assigned
21	AC-	Y	DC Common
22	Watchdog Timer	Z	External Test Reset
23	+24VDC	AA	+24VDC
24	Tied to Pin 25	BB	Stop Time (Output)
25	Tied to Pin 24	CC	Not Assigned
26	Not Assigned	DD	Not Assigned
27	Relay Output, Side #3, N.O.	EE	Relay Output, Side #2, Common
28	Relay Output, Side #1, N.C.	FF	AC+

-- Slotted for keying between Pins 17/U and 18/V

---

**CONFLICT PROGRAM CARD PIN ASSIGNMENTS**

---

<b>Pin #</b>	<b>Function (Back Side)</b>	<b>Pin #</b>	<b>Function (Component Side)</b>
1	Channel 2 Green	A	Channel 1 Green
2	Channel 3 Green	B	Channel 2 Green
3	Channel 4 Green	C	Channel 3 Green
4	Channel 5 Green	D	Channel 4 Green
5	Channel 6 Green	E	Channel 5 Green
6	Channel 7 Green	F	Channel 6 Green
7	Channel 8 Green	H	Channel 7 Green
8	Channel 9 Green	J	Channel 8 Green
9	Channel 10 Green	K	Channel 9 Green
10	Channel 11 Green	L	Channel 10 Green
11	Channel 12 Green	M	Channel 11 Green
12	Channel 13 Green	N	Channel 12 Green
13	Channel 14 Green	P	Channel 13 Green
14	Channel 15 Green	R	Channel 14 Green
15	Channel 16 Green	S	Channel 15 Green
16	N/C	T	PC AJAR
17	Channel 1 Yellow	U	Channel 9 Yellow
18	Channel 2 Yellow	V	Channel 10 Yellow
19	Channel 3 Yellow	W	Channel 11 Yellow
20	Channel 4 Yellow	X	Channel 12 Yellow
21	Channel 5 Yellow	Y	Channel 13 Yellow
22	Channel 6 Yellow	Z	Channel 14 Yellow
23	Channel 7 Yellow	AA	Channel 15 Yellow
24	Channel 8 Yellow	BB	Channel 16 Yellow
--		--	
25	Channel 17 Green	CC	Channel 17 Yellow
26	Channel 18 Green	DD	Channel 18 Yellow
27	Channel 16 Green	EE	PC AJAR (Program Card)
28	Yellow Inhibit Common	FF	Channel 17 Green

-- Slotted for keying between Pins 24/BB and 25/CC

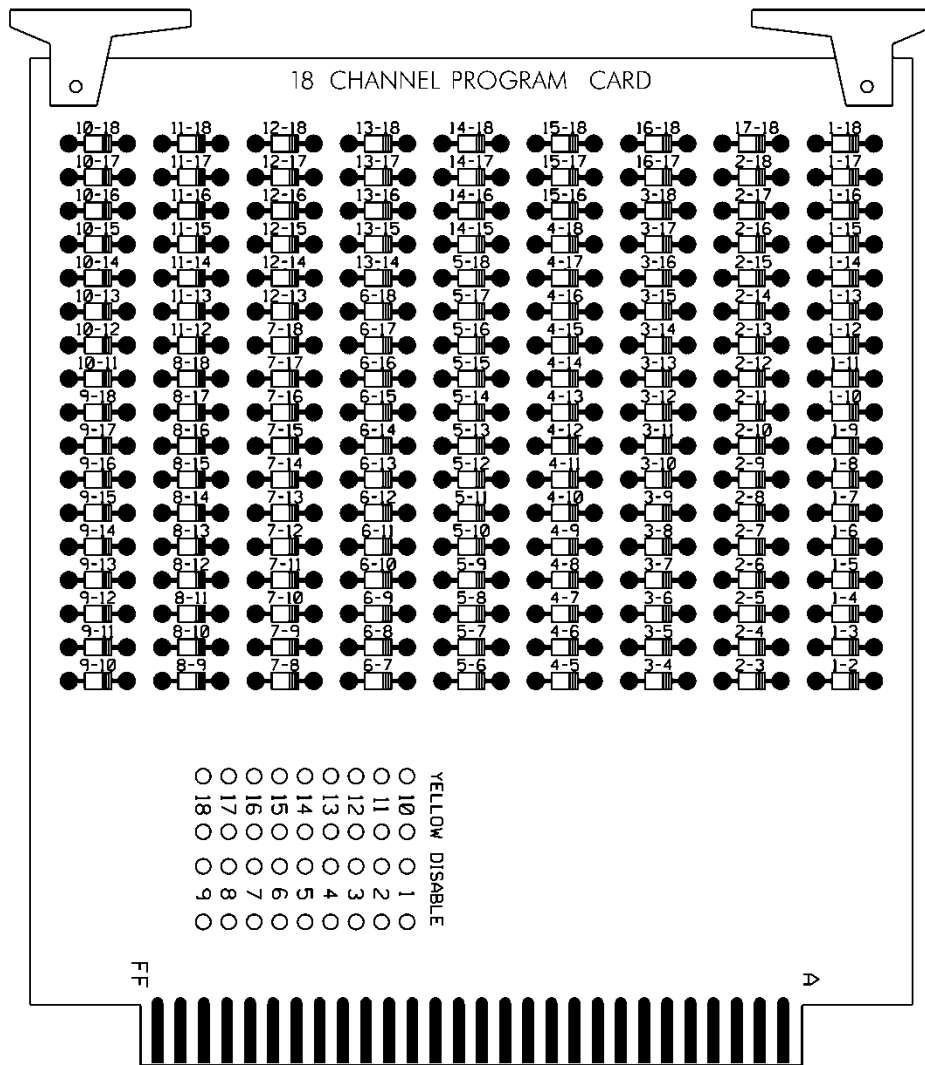

**5. Preemption and Sign Control Box**

Provide preemption and sign control box to operate in a Model 332 and Model 336S cabinet. Provide hardware to mount the box to the cage of the cabinet to ensure the front side is facing the opposite side of the cabinet. Furnish the material of the box from a durable finished metallic or thermoplastic case. Ensure the size of the box is not greater than 7(l) x 5(w) x 5(d) inches. Ensure that no modification is necessary to mount the box on the cabinet cage.

Provide the following components in the preemption and sign control box: relays, fuses, terminal blocks, MOVs, resistor, RC network, lamp, and push button switch.

Provide UL Listed or Recognized relay K1 as a DPDT enclosed relay (120 VAC, 60 Hz coil) with an 8-pin octal-style plug and associated octal base. Provide contact material made of AgCdO with a 10 amp, 240 VAC rating. Ensure the relay has a specified pickup voltage of 102 VAC.

Provide relay SSR1 as a Triac SPST normally open solid state relay that is rated for 120 VAC input and zero-crossing (resistive load) 25 amp @ 120 VAC output. Ensure the relay turns on at 90 Vrms within 10 ms and turns off at 10 Vrms within 40 ms. Ensure the relay has physical

characteristics as shown in the wiring detail in Figure 1. Provide 4 terminal screws with saddle clamps.

Provide fuses F1 and F2 as a UL Listed ¼" x 1-1/4" glass tube rated at 250 volts with a 10kA interrupting rating. Ensure F1 non-delay (fast-acting) and F2 slow-blow (time-delay) fuses have a maximum opening times of 60 minutes and 120 seconds for currents of 135 and 200 percent of the ampere rating, respectively. Ensure F2 slow-blow (time-delay) fuses have a minimum opening times of 12 seconds at 200 percent of the ampere rating. Provide fuse holders that are UL Recognized panel-mounted holders rated 250V, 15 ampere minimum with bayonet-type knobs which accept ¼" x 1-1/4" glass tube fuses.

Provide terminal blocks that are rated for 300V and are made of electrical grade thermoplastic or thermosetting plastic. Ensure each terminal block is of closed back design and has recessed-screw terminals with molded barriers between terminals. Ensure each terminal block is labeled with a block designation. Ensure each terminal is labeled with the function and a number.

Provide 3/4-inch diameter radial lead UL-recognized metal oxide varistors (MOVs) that have electrical performance as outlined below.

<b>PROPERTIES OF MOV SURGE PROTECTOR</b>	
Maximum Continuous Applied Voltage at 185° F	150 VAC (RMS) 200 VDC
Maximum Peak 8x20µs Current at 185° F	6500 A
Maximum Energy Rating at 185° F	80 J
Voltage Range 1 mA DC Test at 77° F	212-268 V
Max. Clamping Voltage 8x20µs, 100A at 77° F	395 V
Typical Capacitance (1 MHz) at 77° F	1600 pF

Provide resistor R1 as a 2K ohm, 12 watt, wirewound resistor with tinned terminals and attaching leads. Ensure the resistor is spaced apart from surrounding wires.

Provide a LED or incandescent lamp that has a voltage rating of 120 VAC with a minimum life rating at 50,000 hours.

Wire the preemption and sign control box as shown in Figure 1.

**RAILROAD PREEMPTION WIRING DETAIL**

(wire as shown below)

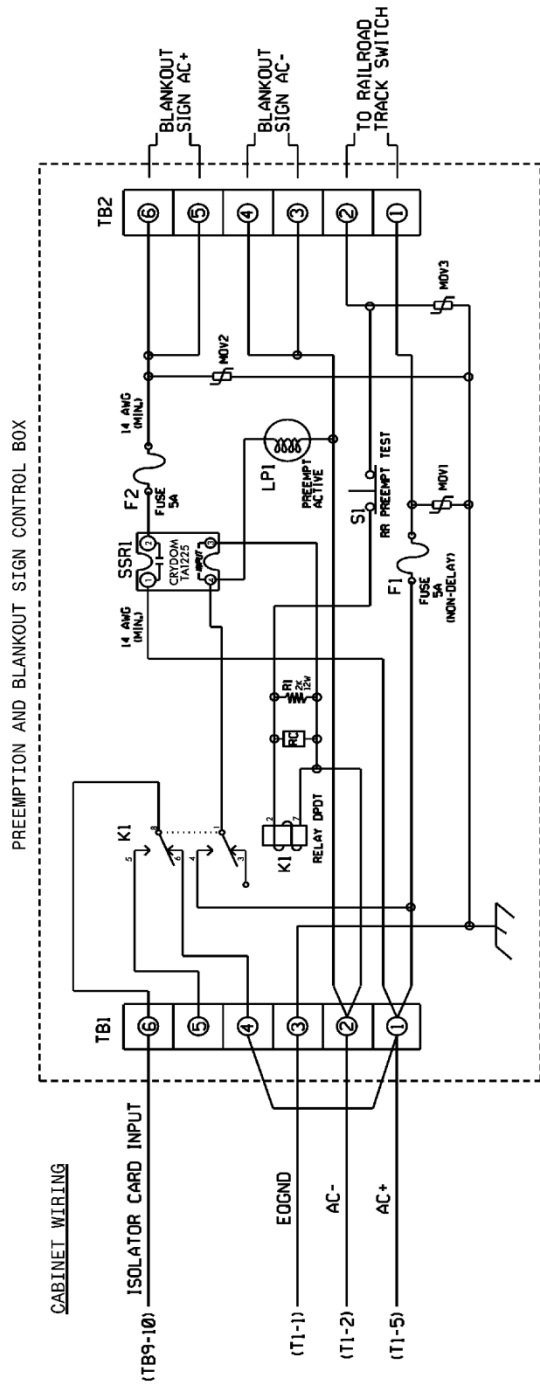

**NOTES**

1. RELAY K1 IS SHOWN IN THE ENERGIZED (PREEMPT NOI ACTIVE) NORMAL OPERATION STATE.
2. AC ISOLATOR CARD SHALL ACTIVATE PREEMPTION UPON REMOVAL OF AC+ FROM INPUT (AS SHOWN ABOVE). THIS IS ACCOMPLISHED BY SETTING TYPE 252 AC ISOLATOR CARD TO INVERTED OPERATION.

**FRONT VIEW**

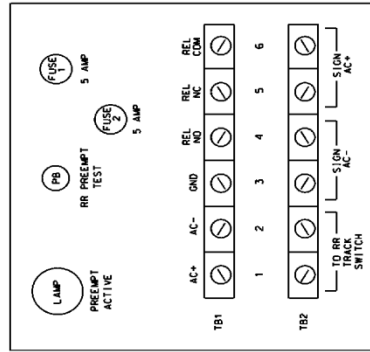

Figure 1

**E. Type 170 Detector Sensor Units**

Furnish detector sensor units that comply with Chapter 5 Section 1, "General Requirements," and Chapter 5 Section 2, "Model 222 & 224 Loop Detector Sensor Unit Requirements," of the CALTRANS "Transportation Electrical Equipment Specifications" dated March 12, 2009 with Erratum 1.

**23.3. CONSTRUCTION METHODS****A. General**

Remove existing controllers and cabinets where required. Remove maintenance diary from cabinet and place in new cabinet. Take existing equipment out of service only at the time directed.

Locate new cabinets so as not to obstruct sight distance of vehicles turning on red.

Install controllers, cabinets, detector sensor units and hardware that provide required phasing, color sequence, flash sequence, interconnection, railroad clearance and preemption and emergency vehicle clearance and preemption.

Stencil signal inventory number on cabinet side facing roadway. Use 3" black characters.

Provide external electrical service disconnect at all new and existing cabinet locations unless otherwise specified.

Do not program controller for late night flashing operation at railroad preemption installations. For all other installations, do not program controller for late night flashing operation unless otherwise directed. Ensure all signal heads for same approach flash concurrently during flashing operation.

Provide serial number and cabinet model number for each new controller and controller cabinet installed.

Install pole mounted cabinets so height to cabinet middle is 4 ft.

Activate controllers with proposed phasing and timing.

**B. Workshop**

Provide enclosed workshop to set up and test new controllers and cabinets before installation. Locate workshop within Division responsible for project administration. Ensure workshop provides protection from weather and sufficient space to house 2 test observers, all necessary test equipment and material, controllers and cabinets.

Configure and test each controller and cabinet to match the proposed signal design. Ensure all equipment furnished and installed or modified by the Contractor at each location operates in full compliance with the plans and project special provisions. Test each controller and cabinet for proper color sequence, flashing operation, phase timings, preemption, coordination and conflict monitor programming or malfunction management unit programming. Ensure that simultaneous conflicting phase outputs will cause the cabinet to revert to flashing operation. For intersections with any type of preemption, submit a completed Preemption Test Procedure Checklist. The checklist is located on the Department's website at <https://connect.ncdot.gov/resources/safety/Pages/ITS-and-Signals.aspx>.

Test the cabinet and controller for eight hours minimum. Following this test and before installation, the Engineer will inspect the equipment in operation. The Engineer may require other tests to ensure proper operation. These tests shall be at no additional cost to the Department.

### **C. Railroad Preemption**

Where railroad preemption is required, coordinate all work with the railroad company. Do not place signals into operation until signal equipment has been interconnected with required railroad-highway crossing devices and railroad preemption is working properly. Ensure preemption sequences begin immediately after activation of train detection.

Contact and coordinate with the railroad company to schedule interconnection of the signal to the railroad controller cabinet. Install lead-in cable from the signal controller cabinet to a railroad company furnished and installed lockable junction box. Interconnection will be made by the railroad company.

Provide fail-safe operation such that removal of voltage from the railroad side of the isolation relay will initiate the railroad preemption sequence.

### **D. Vehicle Preemption**

Where required, preserve the existing emergency vehicle preemption systems functionality during signal cabinet change-outs or other cabinet modifications by reusing and/or providing all necessary equipment and hardware. This work shall be considered incidental to the installation of new signal cabinets.

### **E. Vehicle Detection**

Where required, preserve the existing video and/or microwave radar vehicle detection systems functionality during signal cabinet change-outs or other cabinet modifications by reusing and/or providing all necessary equipment and hardware. This work shall be considered incidental to the installation of new signal cabinets.

### **F. Audible Pedestrian Signals**

Where required, preserve the existing audible pedestrian signal functionality during signal cabinet change-outs or other cabinet modifications by reusing and/or providing all necessary equipment and hardware. This work shall be considered incidental to the installation of new signal cabinets.

### **G. Red Light Cameras**

At locations shown in the Summary of Work table of the Plans, some intersections are included in the City of Fayetteville's Red Light Camera Program. The Contractor shall notify the Engineer and City representatives a minimum of seven (7) calendar days prior to performing any work at each of these locations. During cabinet change-outs, or any other activity that places the signal into flash or darkens the signal heads, the Contractor shall disconnect and preserve the wire(s) in the signal cabinet that are integrated with the red light camera(s) at the intersection. Under no conditions shall the Contractor re-connect the wire(s), as this will be completed by the red light camera integrator or vendor.

## **23.4. MEASUREMENT AND PAYMENT**

*Controllers with Cabinet* (\_\_\_\_) will be measured and paid as the actual number of each type of controllers with cabinets furnished, installed, and accepted.

*Detector Card* (\_\_\_\_) will be measured and paid as the actual number furnished, installed, and accepted.



No measurement will be made of conflict monitors, external electrical service disconnect, grounding systems, modems, meter bases and workshop as these will be incidental to furnishing and installing controllers with cabinets.

Payment will be made under:

<b>Pay Item</b>	<b>Pay Unit</b>
Controller with Cabinet (2070E, 332 Base Mounted) .....	Each
Controller with Cabinet (2070E, 336S Pole Mounted).....	Each
Controller with Cabinet and Aux File (2070E, 332 Base Mounted) .....	Each
Controller with Cabinet and Aux File (2070E, 336S Pole Mounted).....	Each
Detector Card (2070L).....	Each

**24. MODIFY CABINET FOUNDATIONS**

**24.1. DESCRIPTION**

Where approved by the Engineer, install conduit entrances into existing foundations in accordance with the plans and specifications. Modify existing foundations in accordance with the plans and specifications.

**24.2. MATERIAL**

Material, equipment and hardware under this section that is pre-approved on the ITS and Signals QPL.

Refer to Articles 100-4 (Portland Cement Concrete) and 1098-15 (Signal Cabinet Foundation) of the Standard Specifications.

**24.3. CONSTRUCTION METHODS**

Modify signal cabinet foundations in compliance with all requirements of Section 1752-3 of the Standard Specifications.

**24.4. MEASUREMENT AND PAYMENT**

*Conduit Entrance into Existing Foundation* will be measured and paid as the actual number of conduit entrances drilled into existing cabinet foundations furnished, installed and accepted.

*Modify Foundation for Controller Cabinet* will be measured and paid as the actual number of existing cabinet foundations modified and accepted.

Payment will be made under:

<b>Pay Item</b>	<b>Pay Unit</b>
Conduit Entrance into Existing Foundation.....	Each
Modify Foundation for Controller Cabinet.....	Each

**25. CABINET BASE ADAPTER/EXTENDER**

**25.1. DESCRIPTION**

Furnish and install cabinet base adapters and extenders with all necessary hardware for Type 170 cabinets.

**25.2. MATERIAL**

Furnish material, equipment and hardware under this section that is pre-approved on the ITS and Signals QPL.

Refer to Article 1098-16 (Cabinet Base Adapter or Extender) of the Standard Specifications.

**25.3. CONSTRUCTION METHODS**

Install cabinet base adapters and extenders in compliance with all requirements of Section 1753-3 of the Standard Specifications.

**25.4. MEASUREMENT AND PAYMENT**

*Cabinet Base Adapters* will be measured and paid as the actual number furnished, installed and accepted.

*Cabinet Base Extenders* will be measured and paid as the actual number furnished, installed and accepted.

Payment will be made under:

<b>Pay Item</b>	<b>Pay Unit</b>
Cabinet Base Adapter .....	Each
Cabinet Base Extender .....	Each

## 26. ELECTRICAL SERVICE

### 26.1. DESCRIPTION

Install new electrical service equipment as shown in the Plans. The first item of work on this project is the installation of all electrical service poles and meter base/disconnect combination panels to expedite the power service connections. Comply with the National Electrical Code (NEC), the National Electrical Safety Code (NESC), the Standard Specifications, the Project Special Provisions, and all local ordinances.

All work involving electrical service shall be coordinated with the appropriate utility company and the Signal Supervisor from NCDOT Division 6 Traffic Services.

### 26.2. MATERIAL

#### A. Meter Base/Disconnect Combination Panel

Furnish and install new meter base/disconnect combination panels as shown in the Plans. Provide meter base/disconnect combination panels that have a minimum of four (4) spaces in the disconnect. Furnish a single pole 15A circuit breaker with a minimum of 10,000 RMS symmetrical amperes short circuit current rating in a lockable NEMA 3R enclosure. Ensure meter base/ disconnect combination panel is listed as meeting UL Standard UL-67 and marked as being suitable for use as service equipment. Ensure circuit breakers are listed as meeting UL-489. Fabricate enclosure from galvanized steel and electrostatically apply dry powder paint finish, light gray in color, to yield a minimum thickness of 2.4 mils. All exterior surfaces must be powder coated steel. Provide ground bus and neutral bus with a minimum of four terminals and a minimum wire capacity range of number 12 through number 3 AWG.

All new electrical breakers shall be labeled with the maximum available fault current. The Department will obtain this information from the utility company and the Contractor shall request it from the Engineer.

Furnish NEMA Type 3R combinational panel rated 200 Ampere minimum that meets the requirements of the local utility. Provide meter base with sockets' ampere rating based on sockets being wired with a minimum of 167 degrees F insulated wire. Furnish 4 terminal, 600 volt, single phase, 3-wire meter bases that comply with the following:

- Line, Load, and Neutral Terminals accept 4/0 AWG and smaller Copper/Aluminum wire
- With or without horn bypass
- Made of galvanized steel
- Listed as meeting UL Standard US-414
- Overhead or underground service entrance specified.

Furnish 1.25" watertight hub for threaded rigid conduit with meter base.

At the main service disconnect, furnish and install UL-approved lightning arrestors that meet the following requirements:

Type of design	Silicon Oxide Varistor
Voltage	120/240 Single Phase, 3 wire
Maximum current	100,000 amps
Maximum energy	3000 joules per pole
Maximum number of surges	Unlimited
Response time one milliamp test	5 nanoseconds
Response time to clamp 10,000 amps	10 nanoseconds
Response time to clamp 50,000 amps	25 nanoseconds
Leak current at double the rated voltage	None
Ground wire	Separate

### **B. Equipment Cabinet Disconnect**

Provide new equipment cabinet disconnects when the meter base/disconnect combination panel is not adjacent or in the same intersection quadrant as the equipment cabinet. Furnish single pole 15A circuit breaker. Furnish panels that have a minimum of four (4) spaces in the disconnect. Furnish circuit breakers with a minimum of 10,000 RMS symmetrical amperes short circuit current rating in a lockable NEMA 3R enclosure. Ensure meter base/ disconnect combination panel is listed as meeting UL Standard UL-67 and marked as being suitable for use as service equipment. Ensure circuit breakers are listed as meeting UL-489. Fabricate enclosure from galvanized steel and electrostatically apply dry powder paint finish, light gray in color, to yield a minimum thickness of 2.4 mils. All exterior surfaces must be powder coated steel. Provide ground bus and neutral bus with a minimum of four terminals and a minimum wire capacity range of number 12 through number 3 AWG.

### **C. 3-Wire Copper Service Entrance Conductors**

Furnish 3-wire stranded copper service entrance conductors with THWN rating. Provide conductors with black, red, and white insulation that are intended for power circuits at 600 Volts or less and comply with the following:

- Listed as meeting UL Standard UL-83
- Meets ASTM B-3 and B-8 or B-787 standards.

See the Plans for wire sizes and quantities.

### **D. 3-Wire Copper Feeder Conductors**

Furnish 3-wire stranded copper feeder conductors with THWN rating for supplying power to CCTV field equipment cabinets. Provide conductors with black or red, white, and green insulation that are intended for power circuits at 600 Volts or less and comply with the following:

- Listed as meeting UL Standard UL-83
- Meets ASTM B-3 and B-8 or B-787 standards.

See the Plans for wire sizes and quantities.

### **E. Grounding System**

Furnish 5/8"x10' copper clad steel grounding electrodes (ground rods), #4 AWG solid bare copper conductors, and exothermic welding kits for grounding system installations. Comply with the NEC, Standard Specifications, these Project Special Provisions, and the Plans.

## **26.3. CONSTRUCTION METHODS**

### **A. General**

Coordinate with the Engineer and the utility company to de-energize the existing service temporarily prior to starting any modifications.

Permanently label cables at all access points using nylon tags labeled with permanent ink. Ensure each cable has a unique identifier. Label cables immediately upon installation. Use component name and labeling scheme approved by the Engineer.

### **B. Meter Base/Disconnect Combination Panel**

Install meter base/disconnect combination panels with lightning arrestors as called for in the Plans. Route the feeder conductors from the meter base/disconnect to the equipment cabinet in conduit. Provide rigid galvanized conduit for above ground and PVC for below ground installations.

### **C. Electrical Service Disconnect**

Install equipment cabinet disconnects and circuit breakers as needed. Install THWN stranded copper feeder conductors as shown in Plans between the electrical service disconnect and the equipment cabinet disconnect. Route the conductors from the equipment cabinet disconnect to the equipment cabinet in rigid galvanized steel conduit. Bond the equipment cabinet disconnect in accordance with the NEC. Ensure that the grounding system complies with the grounding requirements of these Project Special Provisions, the Standard Specifications and the Plans.

### **D. 3-Wire Copper Service Entrance Conductors**

Furnish and install 3-wire THWN stranded copper service entrance conductors in 1.25 inch rigid galvanized risers as shown in the plans. Install a waterproof hub on top of the electrical service disconnect for riser entrance/exit. Size the conductors as required by the load and distance. Comply with the Standard Specifications and Standard Drawings and all applicable electrical codes.

### **E. 3-Wire Copper Feeder Conductors**

Install 3-wire THWN stranded copper feeder conductors to supply 120 VAC to the CCTV field equipment cabinets. Size the conductors as required by the load and distance. Comply with the Standard Specifications and Standard Drawings and all applicable electrical codes.

### **F. Grounding System**

Install ground rods as indicated in the Plans. Connect the #4 AWG grounding conductor to ground rods using an exothermic welding process. Test the system to ensure a ground resistance of 20-ohms or less is achieved. Drive additional ground rods as necessary or as directed by the Engineer to achieve the proper ground resistance.

**26.4. MEASUREMENT AND PAYMENT**

*New Electrical Service* will be measured and paid as the actual number of services furnished, installed, and accepted.

No measurement will be made of riser assemblies, meter bases, service disconnects, underground and exposed conduit runs to the cabinet, acquisition of service fees, electrical service conductors, ground rod, ground wire and any remaining hardware and conduit to connect the electrical service to the cabinet as these are incidental to furnishing and installing new electrical service.

Payment will be made under:

<b>Pay Item</b>	<b>Pay Unit</b>
New Electrical Service.....	Each

## 27. DIGITAL CCTV EQUIPMENT

### 27.1. DESCRIPTION

Furnish and install digital CCTV equipment described in these Project Special Provisions. All new CCTV cameras shall be fully compatible with the video management software that is being integrated under this Project.

Contact the City of Fayetteville to confirm all CCTV locations prior to beginning construction.

### 27.2. MATERIAL

#### A. General

Furnish and install new CCTV camera assemblies at the locations shown on the Plans. Each assembly consists of the following:

- One dome CCTV color digital signal processing camera unit with zoom lens, filter, control circuit, and accessories in a single enclosed unit
- Support H.264 compression for video transmission using IP protocols
- Motorized pan, tilt, and zoom
- Pole-mount camera attachment assembly
- All necessary cable, connectors and incidental hardware to make a complete and operable system
- A lightning arrestor installed in-line between the CCTV camera and the equipment cabinet components.
- A NEMA-rated enclosure constructed of aluminum with a clear acrylic dome or approved equal Camera Unit housing.

#### B. Camera and Lens

##### 1. Cameras

Furnish new charged-coupled device (CCD) color cameras. The camera must meet the following minimum requirements:

- Sensor size: 1/2.8 inch
- Video Resolution: 1920x1080 (HDTV 1080p)
- Aspect Ratio: 16:9
- Overexposure protection: The camera shall have built-in circuitry or a protection device to prevent any damage to the camera when pointed at strong light sources, including the sun
- Low light condition imaging
- Wide dynamic range (WDR) operation
- Electronic image stabilization
- Automatic focus with manual override

##### 2. Zoom Lens

Furnish each camera with a motorized zoom lens that is high performance integrated dome system or approved equivalent with automatic iris control with manual override and neutral density spot filter. Furnish lenses that meet the following optical specifications:

- 30X optical zoom, and 12X electronic zoom
- Preset positioning: 64 Presets



The lens must be capable of both automatic and remote manual control iris and focus override operation. The lens must be equipped for remote control of zoom and focus, including automatic movement to any of the preset zoom and focus positions. Mechanical or electrical means must be provided to protect the motors from overrunning in extreme positions. The operating voltages of the lens must be compatible with the outputs of the camera control.

### **3. Communication Standards:**

The CCTV camera shall support the appropriate NTCIP 1205 communication protocol (version 1.08 or higher), ONVIF, or approved equal.

### **4. Networking Standards:**

- Network Connection: 10/100 Mbps auto-negotiate
- Frame Rate: up to 60 fps
- Data Rate: scalable
- Built-in Web Server
- Unicast & multicast support
- Two simultaneous video streams (Dual H.264 and MJPEG):
  - Video 1: H.264 (Main Profile, at minimum)
  - Video 2: H.264 or MJPEG
- Supported Protocols: DNS, IGMPv2, NTP, RTSP, RTP, TCP, UDP, DHCP, HTTP, IPv4

The video camera shall allow for the simultaneous encoding and transmission of the two digital video streams, one in H.264 format (high-resolution) and one in H.264 or MJPEG format (low-resolution).

Initially use UDP/IP for video transport and TCP/IP for camera control transport unless otherwise approved by the Engineer.

The 10/100BaseTX port shall support half-duplex or full-duplex and provide auto negotiation, and shall be initially configured for full-duplex.

The camera unit shall be remotely manageable using standard network applications via web browser interface administration. Telnet or SNMP monitors shall be provided.

### **C. Camera Housing**

Furnish new dome style enclosure for the CCTV assemblies. Equip each housing with mounting assembly for attachment to the CCTV camera pole. The enclosures must be equipped with a sunshield and be fabricated from corrosion resistant aluminum and finished in a neutral color of weather resistant enamel. The enclosure must meet or exceed NEMA 4X ratings. The viewing area of the enclosure must be tempered glass.

### **D. Pan and Tilt Unit**

Equip each new dome style assembly with a pan and tilt unit. The pan and tilt unit must be integral to the high performance integrated dome system. The pan and tilt unit must be rated for outdoor operation, provide dynamic braking for instantaneous stopping, prevent drift, and have minimum backlash. The pan and tilt units must meet or exceed the following specifications:

- Pan: continuous 360 Degrees
- Tilt: up/down 90 degrees minimum
- Motors: Two-phase induction type, continuous duty, instantaneous reversing
- Preset Positioning: 64 PTZ presets per camera

**E. Control Receiver/Driver**

Provide each new camera unit with a control receiver/driver that is integral to the CCTV dome assembly. The control receiver/driver will receive serial asynchronous data initiated from a camera control unit, decode the command data, perform error checking, and drive the pan/tilt unit, camera controls, and motorized lens. As a minimum, the control receiver/drivers must provide the following functions:

- Zoom in/out
- Automatic focus with manual override
- Tilt up/down
- Automatic iris with manual override
- Pan right/left
- Minimum 64 preset positions for pan, tilt, and zoom

In addition, each control receiver/driver must accept status information from the pan/tilt unit and motorized lens for preset positioning of those components. The control receiver/driver will relay pan, tilt, zoom, and focus positions from the field to the remote camera control unit. The control receiver/driver must accept “goto” preset commands from the camera control unit, decode the command data, perform error checking, and drive the pan/tilt and motorized zoom lens to the correct preset position. The preset commands from the camera control unit will consist of unique values for the desired pan, tilt, zoom, and focus positions.

**F. Electrical**

The camera assembly shall support power-over-Ethernet (PoE) in compliance with IEEE 802.3af. Provide any external power injector that is required for PoE with each assembly.

**G. CCTV Camera Attachment to Pole**

Furnish and install an attachment assembly for the CCTV camera unit. Use stainless steel banding approved by the Engineer.

Furnish CCTV attachments that allow for the removal and replacement of the CCTV enclosure as well as providing a weatherproof, weather tight, seal that does not allow moisture to enter the enclosure.

Furnish a CCTV Camera Attachment Assembly that is able to withstand wind loading at the maximum wind speed and gust factor called for in these Special Provisions and can support a minimum camera unit dead load of 45 pounds (20.4 kg).

**H. Surge Suppression**

Protect all equipment with metal oxide varistors connecting each power conductor to ground.

Protect the electrical and Ethernet cables from the CCTV unit entering the equipment cabinet with surge protection. Provide an integrated unit that accepts unprotected electrical and Ethernet connections and outputs protected electrical and Ethernet connections. Ethernet connections shall be RJ45 with full gigabit Ethernet transmission speeds and electrical connections shall be #22-#14 AWG screw terminals. The surge protection unit shall comply with EIA/TIA568A and EIA/TIA568B standards for data transmission and automatically reset.

**27.3. CONSTRUCTION METHODS**

**A. General**

Mount CCTV camera units at a height sufficient to adequately see traffic in all directions and as approved by the Engineer. The maximum attachment height for cameras is 35 feet above ground level.

Mount the CCTV camera units such that a minimum 5 feet of clearance is maintained between the camera and the top of the pole.

Obtain approval of the camera locations and orientation from the Engineer prior to installing the CCTV camera assemblies.

Mount CCTV cameras on the side of poles nearest intended field of view. Avoid occluding the view with the pole.

**B. Electrical and Mechanical Requirements**

Ground all equipment as called for in the Standard Specifications, these Special Provisions, and the Plans.

Install surge protectors on all ungrounded conductors entering the CCTV enclosure. House the protectors in a small, ventilated weatherproof cabinet attached near the CCTV attachment point in a manner approved by the Engineer.

**27.4. MEASUREMENT AND PAYMENT**

*Digital CCTV camera assembly* will be measured and paid as the actual number of digital CCTV assemblies furnished, installed, integrated, and accepted. No separate measurement will be made for electrical cabling, connectors, CCTV camera attachment assemblies, conduit, condulets, grounding equipment, surge protectors, or any other equipment or labor required to install the digital CCTV assembly.

Ethernet cable and risers that are required to connect the camera to an Ethernet switch will be paid for separately.

Payment will be made under:

<b>Pay Item</b>	<b>Pay Unit</b>
Digital CCTV Camera Assembly .....	Each

**28. FIELD EQUIPMENT CABINET****28.1. DESCRIPTION**

Furnish 336S pole mounted or base mounted cabinets to house CCTV control and/or communications equipment at the following locations as shown in the Plans:

- Owen Drive at Dyer Street (CCTV-42)
- Robeson Street at MLK Jr. Freeway (CCTV-44)
- Ramsey Street at Bartow Drive (CCTV-51)

At all other CCTV locations, the camera equipment will be installed in existing CCTV cabinets or in existing traffic signal cabinets.

The cabinets must consist of a cabinet housing, 19-inch EIA mounting cage, and power distribution assembly (PDA #3 as described in the CALTRANS TSCES).

The cabinet housing must conform to sections 6.2.2 (Housing Construction), 6.2.3 (Door Latches and Locks), 6.2.4 (Housing Ventilation), and 6.2.5 (Hinges and Door Catches) of the CALTRANS TSCES. Do not equip the cabinet housings with a police panel.

The cabinet cage must conform to section 6.3 of the CALTRANS TSCES.

Terminal blocks on the PDA #3 Assembly have internal wiring for the Model 200 switch pack sockets. Do not use terminal blocks on PDA #3 as power terminals for cabinet devices. Do not furnish cabinet with "Input Panels" described in section 6.4.7.1 of the TSCES. Do furnish cabinet with "Service Panels" as described in section 6.4.7.1 of the TSCES and as depicted on drawing TSCES-9 in the TSCES. Use service panel #2.

Furnish terminal blocks for power for cabinet CCTV and communications devices as needed to accommodate the number of devices in the cabinet.

Do not furnish cabinets with C1, C5, or C6 harness, input file, output file, monitor units, model 208 unit, model 430 unit, or switch packs.

Furnish all conduits, shelving, mounting adapters, and other equipment as necessary to route cabling, mount equipment, and terminate conduit in equipment cabinet.

**28.2. MATERIAL****A. Shelf Drawer**

Provide a pull out, hinged-top drawer, having sliding tracks, with lockout and quick disconnect feature, such as a Vent-Rak Retractable Writing Shelf, #D-4090-13 or equivalent in the equipment cabinet. Furnish a pullout drawer that extends a minimum of 14 inches that is capable of being lifted to gain access to the interior of the drawer. Minimum interior dimensions of the drawer are to be 1 inch high, 13 inches deep, and 16 inches wide. Provide drawers capable of supporting a 40-pound device or component when fully extended.

**B. Cabinet Light**

Each cabinet must include two (2) fluorescent lighting fixtures (one front, one back) mounted horizontally inside the top portion of the cabinet. The fixtures must include a cool white lamp, and

must be operated by normal power factor UL-listed ballast. A door-actuated switch must be installed to turn on the applicable cabinet light when the front door or back door is opened. The lights must be mounted not to interfere with the upper door stay.

### **C. Surge Protection for System Equipment**

Each cabinet must be provided with devices to protect the CCTV and communications equipment from electrical surges and over voltages as described below.

#### **1. Main AC Power Input**

Each cabinet must be provided with a hybrid-type, power line surge protection device mounted inside the power distribution assembly. The protector must be installed between the applied line voltage and earth ground. The surge protector must be capable of reducing the effect of lighting transient voltages applied to the AC line. The protector must be mounted inside the Power Distribution Assembly housing facing the rear of the cabinet. The protector must include the following features and functions:

- Maximum AC line voltage: 140 VAC.
- Twenty pulses of peak current, each of which must rise in 8 microseconds and fall in 20 microseconds to ½ the peak: 20000 Amperes.
- The protector must be provided with the following terminals:
  - Main Line (AC Line first stage terminal).
  - Main Neutral (AC Neutral input terminal).
  - Equipment Line Out (AC line second stage output terminal, 19 amps).
  - Equipment Neutral Out (Neutral terminal to protected equipment).
  - GND (Earth connection).
- The Main AC line in and the Equipment Line out terminals must be separated by a 200 Microhenry (minimum) inductor rated to handle 10 AMP AC Service.
- The first stage clamp must be between Main Line and Ground terminals.
- The second stage clamp must be between Equipment Line Out and Equipment Neutral.
- The protector for the first and second stage clamp must have an MOV or similar solid state device rated at 20 KA and must be of a completely solid state design (i.e., no gas discharge tubes allowed).
- The Main Neutral and Equipment Neutral Out must be connected together internally and must have an MOV similar solid state device or gas discharge tube rated at 20 KA between Main Neutral and Ground terminals.
- Peak Clamp Voltage: 350 volts at 20 KA. (Voltage measured between Equipment Line Out and Equipment Neutral Out terminals. Current applied between Main Line and Ground Terminals with Ground and Main Neutral terminals externally tied together).
- Voltage must never exceed 350 volts.
- The Protector must be epoxy-encapsulated in a flame-retardant material.
- Continuous service current: 10 Amps at 120 VAC RMS.

- The Equipment Line Out must provide power to cabinet CCTV and communications equipment and to the 24V power supply.

**2. Ground Bus**

Provide a neutral bus that is not connected to the earth ground or the logic ground anywhere within the cabinet. Ensure that the earth ground bus and the neutral ground bus each have ten compression type terminals, each of which can accommodate wires ranging from number 14 through number 4 AWG.

**D. Technician Pad**

At each location where a pole-mounted field equipment cabinet is installed, the Contractor shall also install a technician pad for the cabinet. The pad shall be concrete and provide a minimum work area of 24” (length) by 30” (width) in front of the cabinet door. Comply with Article 1750-2 of the Standard Specifications for materials to be used for concrete foundations.

**28.3. CONSTRUCTION METHODS**

For each field equipment cabinet installation, use stainless steel banding or other method approved by the Engineer to fasten cabinet to pole. Install field equipment cabinets so that the height to the middle of the enclosure is 4 feet from ground level. No risers shall enter the top or sides of the equipment cabinet.

Install all conduits, condulets, and attachments to equipment cabinets in a manner that preserves the minimum bending radius of cables and creates water proof connections and seals.

Install the technician pad per Article 1750-3 of the Standard Specifications.

**28.4. MEASUREMENT AND PAYMENT**

*Field equipment cabinet* will be measured and paid as the actual number of field equipment cabinets furnished, installed and accepted.

No payment will be made for the cabling, connectors, cabinet attachment assemblies, conduit, condulets, risers, concrete technician pad, grounding equipment, surge protectors, or any other equipment or labor required to install the field equipment cabinet and integrate the cabinets with the CCTV and/or communications equipment.

Payment will be made under:

<b>Pay Item</b>	<b>Pay Unit</b>
Field Equipment Cabinet .....	Each

**29. REMOVE EXISTING WIRELESS RADIOS**

**29.1. DESCRIPTION**

This Project includes the removal of existing wireless serial radio systems and the installation of new wireless Ethernet radio systems. At locations shown in the Plans, remove the existing radio and antenna as part of the replacement.

**29.2. CONSTRUCTION METHODS**

At locations shown in the Summary of Work table of the Plans, remove and retain the existing wireless radio and cabling from the signal cabinet. Remove and retain the existing pole-mounted antenna, attachment hardware, risers, cabling, surge protection, splitters, and any other accessories from the pole and cabinet.

The Contractor shall return the radio and antenna from NCDOT-owned signals to the Division 6 Traffic Services Office and from City-owned signals to the City Traffic Services Division. The Contractor shall dispose of all other removed equipment and materials.

**29.3. MEASUREMENT AND PAYMENT**

*Remove Existing Wireless Radio and Antenna* will be measured and paid as the actual number removed and accepted.

Removal and disposal of any materials will be considered incidental. Storage, cost of transportation, tools, materials, all related testing, cost of labor, incidentals and all other equipment necessary to remove the existing materials will be considered incidental.

Payment will be made under:

<b>Pay Item</b>	<b>Pay Unit</b>
Remove Existing Wireless Radio and Antenna .....	Each

### 30. REMOVE EXISTING CCTV ASSEMBLY

#### 30.1. DESCRIPTION

This Project includes the removal of existing analog CCTV camera assemblies and the installation of new digital CCTV camera assemblies. At locations shown in the Plans, remove the existing CCTV cabinet and/or cabinet foundation as part of the camera replacement.

#### 30.2. CONSTRUCTION METHODS

##### A. Remove Existing CCTV Assembly

Remove existing CCTV cameras at locations shown in the Plans. Remove the existing camera, pole attachment hardware, and cabling. Ensure that the existing wood or metal pole is not damaged during the CCTV removal

##### B. Remove Existing Cabinet

Remove existing CCTV cabinets at locations shown in the Plans. Remove the existing control and communications equipment and cabinet.

If the CCTV cabinet has a dedicated electrical service, the Contractor shall also remove this service. Remove the existing conductors and conduit between the cabinet and service. Remove the existing and electrical meter and disconnect equipment and return the meter to the Engineer.

If the CCTV cabinet shares an electrical service with other signal equipment, the Contractor shall only remove the existing conductors and conduit between the cabinet and disconnect.

##### C. Remove Existing Foundation

Remove existing CCTV cabinet foundations at locations shown in the Plans.

Restore the disturbed ground surrounding the removed cabinet foundation to its original, preconstruction condition as determined and approved by the Engineer.

For paved areas, replace removed or damages pavement with in-kind materials, matching the elevation, color, texture, finish, and general appearance of the surrounding pavement. Refer to Section 1 of these Project Special Provisions for additional requirements concerning sidewalks and curbs in historic districts. Replace concrete sidewalk in whole slabs from joint to joint and comply with Section 848 of the Standard Specifications. Replace sidewalk pavers using pavers of the same color, texture, shape, dimensions, and materials as the damaged or modified items. Place graded stone material to temporarily maintain pedestrian traffic where repairs cannot be performed immediately. Comply with Article 545-4 of the Standard Specifications.

For unpaved areas, backfill excavations with removed material, tamp the backfilled material, and rake smooth the top 1 ½ inches. Finish unpaved areas flush with surrounding natural ground and to match the original contour of the ground. Seed with the same type of grass as surrounding area and mulch the newly seeded area. If unpaved area was not grassed, replace the original ground cover in-kind as directed by the Engineer.

Complete repairs to and restoration of all ground (paved and unpaved) disturbed for construction within five consecutive calendar days following initials removal. If the Contractor fails to repair and restore the ground in accordance with these Project Special provisions within the time frame specified, the Department reserves the right to make the necessary repairs, and all expenses incurred



by the Department in making the repairs and restoring the ground will be deducted from payment due the Contractor, plus \$500 liquidated damage per occasion, per day, or any portion thereof, until corrected.

**30.3. MEASUREMENT AND PAYMENT**

*Remove Existing CCTV* \_\_\_ will be measured and paid as the actual number of each item type removed and accepted.

No measurement or payment will be made for restoration of the surrounding unpaved ground surfaces in accordance with these Project Special Provisions as such work will be considered incidental to removing cabinet foundations.

No measurement or payment will be made for furnishing and installing and subsequently removing graded stone material for temporary maintenance of pedestrian traffic where a portion of an existing sidewalk has been removed as such work will be considered incidental to removing cabinet foundations.

Payment will be made under:

<b>Pay Item</b>	<b>Pay Unit</b>
Remove Existing CCTV Assembly .....	Each
Remove Existing CCTV Cabinet.....	Each
Remove Existing CCTV Cabinet and Foundation.....	Each

### 31. LOCAL AREA NETWORK EQUIPMENT

#### 31.1. DESCRIPTION

Furnish, install, configure, and test a 10/100/1000 Gigabit Ethernet local area network (LAN). Furnish LAN that interconnects field devices including signal controllers and CCTV cameras with central hardware including computer workstations, server computers, and CCTV central equipment. Furnish LAN connections as shown on the block diagram.

#### 31.2. MATERIAL

##### A. General

Furnish equipment for the LAN that complies with IEEE standard 802. Furnish Ethernet Switches of all types that are fully compatible and interoperable with the network performance management software and network hardware operating system software.

Furnish Ethernet Switches of all types that comply with the following electrical safety requirements: UL60950 or CSA C22.2 No. 60950 (safety requirements for IT equipment) and FCC Part15 Class A for EMI emissions.

For installations routing cables inside buildings, utilize existing cable raceways, electrical boxes, and metallic conduit where feasible. Where called for in the Plans, install new thin-walled EMT conduit that complies with the NEC and EIA/TIA Standard 569 and commercial building standards for telecommunications pathways.

##### B. Network Performance Management Software

Furnish network performance management and remote monitoring (RMON) software. Furnish the license(s) and additional copies of the software to allow it to be installed on all workstations (up to 10) designated by the Engineer.

Furnish software capable of monitoring all nodes and utilized ports on the enterprise. Furnish software capable of 50% expansion in the number of nodes and ports managed over the number of nodes and ports present and utilized at the final acceptance of the project.

The software shall use a GUI to configure, manage, and monitor the local network. At a minimum, the software shall provide the following functions and features:

- SNMP based
- Full management of network firewall
- Support SSH
- Utilize a GUI Web/browser style interface
- Provide a schematic display of the entire network enterprise that may be drilled down to the port level or panned out to the System level
- Provide Inventory tracking
- Provide bandwidth monitoring

- Provide SMTP support
- Provide auto alerting
- Monitor QOS
- Support management VOIP
- Support NETFLOW
- Support Wireless network management
- Receive SYSlog messages
- Generate usage/error reports
- Be capable of “pushing” upgrades to network gear via TFTP
- Detect switch failures
- Detect router failures
- Detect cable failures
- Provide network performance information
- Support the monitoring of cabinet and equipment temperature alarms via use of SNMP traps.
- Provide switch configuration backup capabilities via TFTP
- Provide configuration change tracking capabilities

### **C. Field Ethernet Switch**

Furnish Field Ethernet switches fabricated for use in field equipment cabinets that are ruggedized to meet or exceed NEMA TS-2 requirements for temperature, shock, humidity, and vibration.

Furnish Field Ethernet Switches that are DIN rail mounted and come equipped with hardware to permit mounting in an EIA 19” equipment rack.

Furnish Field Ethernet Switches that weigh no more than 15 lbs. and are no more than 250 cubic inches in volume.

Furnish Field Ethernet Switches with the following minimum characteristics and features:

- Eight (8) 10BASE-T/100BASE-TX ports:
- Minimum of two (2) 1000 BaseX Optical uplink ports that utilize small form-factor pluggable (SFP) connectors.
- Furnish SFP modules for communications between the TOC and the first switch in Groups 4, 5, 7, 8, 9, 10, 11, 14, 15, and 16 that are rated to transmit and receive Ethernet data at a distance up to 40 km. Use SFP modules that are EX and are matched and compatible with the SFP module it is mated with.

- Furnish SFP modules for all other connections that are rated to transmit and receive Ethernet data at a distance up to 10 km. Use SFP modules that are LX and are matched and compatible with the SFP module it is mated with.
- Furnish SFP modules rated for use with the new optical cable installed under this project.
- Furnish SFP modules with LC connectors.
- SFP modules shall be considered incidental to the field Ethernet switch.
- Management console port

Furnish Field Ethernet switches with the following features:

- 10/100BaseTX ports:
  - RJ45 connectors
  - Cable type: Category 5e, unshielded twisted pair
  - Segment Length: 100m
  - Auto-negotiation support (10/100Mbps)
  - Auto MDIX crossover capability
  - Full Duplex operation (IEEE 802.3x)
  - TVS (transient voltage suppression) between Line +/-, Line +/-ground, and Line - ground to protect the circuitry

Furnish Field Ethernet switches with the following networking requirements:

- The switch shall support automatic address learning of up to 8192 MAC addresses.
- The switch shall support the following advanced layer 2 functions:
  - IEEE 802.1Q VLAN, with support for up to 4096 VLANs
  - IEEE 802.1p priority queuing
  - IEEE 802.1w rapid spanning tree
  - IEEE 802.1s multiple spanning tree
  - IEEE802.1AD link aggregation
  - IEEE 802.3x flow control
  - IGMPv2 with 256 IGMP groups
  - Port Rate Limiting
  - Configuration via test file which can be modified through standard text editor
  - Forwarding/filtering rate shall be 14,880 packets per second (PPS) for 10Mbps, 148,800 for 100Mbps, 1,488,000 for 1000Mbps
  - DHCP Option 82

Furnish Field Ethernet switches with the following network management functionality requirements:

- SNMPv2, SNMPv3
- RMON
- GVRP
- Port Mirroring
- 802.1x port security
- Radius Server
- TACACS+ Server
- SSL – Secure Socket Layer
- SSH – Secure Shell
- TFTP
- Network Time Protocol (NTP)
- Simple Network Time Protocol (SNTP)
- Management via web or Telnet

#### **D. Core Ethernet Switch**

Furnish Core Ethernet Switch with the following minimum characteristics and features:

- L3 core modular, high-availability, switch equipped with redundant fans, power supplies, and support for redundant supervisor/route processor engines, or approved equivalent functionality.
- A minimum of four (4) slots for switch/routing processor modules, but at least one spare slot shall remain after configuring required ports/interfaces herein.
- The following minimum connectors:
  - Minimum of thirty-six (36) 1000 BASEX SFP-based ports with LC fiber connectors (single-mode):
    - Furnish SFP modules for communications between the TOC and the first switch in Groups 4, 5, 7, 8, 9, 10, 11, 14, 15, and 16 that are rated to transmit and receive Ethernet data at a distance up to 40 km. Use SFP modules that are EX and are matched and compatible with the SFP module it is mated with.
    - Furnish SFP modules for communications between the TOC and NCDOT X-0002F access points and Fort Bragg access points that are rated to transmit and receive Ethernet data at a distance up to 40 km. Use SFP modules that are EX and are matched and compatible with the SFP module it is mated with.
    - Furnish SFP modules for all other connections that are rated to transmit and receive Ethernet data at a distance up to 10 km. Use SFP modules that

are LX and are matched and compatible with the SFP module it is mated with.

- Fiber jumper cables with appropriate connectors to connect with switch and adjacent drop cable connectors and/or other switches.
- Ethernet management port: RJ-45 connectors
- Management console port: RJ-45-to-DB9 cable for PC connections
- Minimum of sixteen (16) 10/100/1000 Base-TX copper RJ-45 connectors
- Dynamic Host Configuration Protocol (DHCP)
- Automatic QoS (AutoQoS)
- Autonegotiation on all ports for auto selection of speed and duplexing modes.
- Link Aggregation Control Protocol (LACP)
- Automatic media-dependent interface crossover (MDIX)
- Switching Capacity per line card 300 Gbps
- 256 MB DRAM or greater
- 128 MB FLASH or greater
- 1000 VLANs
- 4000 VLAN IDs
- 1000 Switched Virtual Interfaces (SVIs)
- 9216 Byte Jumbo Frames or greater
- 100 Mpps Forwarding Rate or greater
- Support 1000 IGMP groups and multicast routes
- Support automatic address learning of up to 12,000 MAC addresses
- Security:
  - DHCP Snooping
  - Dynamic ARP Inspection (DAI)
  - Secure Shell (SSH) Protocol, EAP, and Simple Network Management Protocol Version 3 (SNMPv3), Network Time Protocol Version 3 (NTPv3)
  - Port Mirroring
  - TACACS+ and RADIUS authentication

- MAC Address Notification
- Port Security
- Bridge protocol data unit (BPDU) protection and filtering
- Root Guard
- IGMP snooping
- Dynamic VLAN assignment
- Standards: Supply a L3 Ethernet switch that meets or exceeds the following standards:
  - IEEE 802.1s Multiple Spanning Tree Protocol (64 regions)
  - IEEE 802.1w Rapid Reconfiguration Spanning Tree Protocol
  - IEEE 802.1x
  - IEEE 802.3ad
  - IEEE 802.3af
  - IEEE 802.3x full duplex on 10BASE-T, 100BASE-TX, and 1000BASE-T ports
  - IEEE 802.1D Spanning Tree Protocol
  - IEEE 802.1p CoS Prioritization
  - IEEE 802.1Q VLAN
  - IEEE 802.3 10BASE-T specification
  - IEEE 802.3u 100BASE-TX specification
  - IEEE 802.3ab 1000BASE-T specification
  - IEEE 802.3z 1000BASE-X specification
  - An IP gateway redundancy protocol such as virtual router redundancy protocol (VRRP – RFC 2338), hot-standby router protocol (HSRP - proprietary) or gateway load balancing protocol (GLBP - proprietary), or an approved equal will be used to provide a redundant IP gateway in the event of a primary gateway failure.
  - OSPFv2 and v3: RFC 2328 for IPv4 and RFC 5340 for IPv6
- The following Indications:
  - Per-port status LEDs: link integrity, disabled, activity, speed, and full-duplex indications
  - System-status LEDs: system, power supplies, fans, and bandwidth utilization indications

- Environmental Requirements:
  - Operating temperature: 0°C to 40°C minimum range
  - Relative humidity operating: 5 to 90% (non-condensing)
- Mean Time Between Failures of greater than 80,000 hours
- Power Supply
  - Rated to handle input power of 115 VAC/60Hz ( $\pm 10\%$ ), unless otherwise approved by the Engineer
  - Hot-swappable redundant modules
- Physical Requirements
  - EIA standard rack mounting in an IT equipment cabinet
  - No larger than 10 RU
- Safety Requirements
  - FCC Part 15 Class A for EMI emissions

#### **E. Network Ethernet Switch**

Furnish Network Ethernet Switches that are identical to the Core Ethernet Switch provided under this project with the following exceptions:

- Minimum of four (4) 1000BASE-LX SFP-based ports: LC fiber connectors (single-mode) as needed to meet distance requirements at Network Switch and to be compatible with matched Core Switch to support the distances shown in the Plans. Attenuators will be furnished if required to service link without saturating receiving optics.
- Minimum of eight (8) 10/100/1000 Base-TX copper RJ-45 connectors

#### **F. Cable**

Furnish coaxial, Category 6 network cable, RS-232, monitor cabling, and all other cabling in the lengths required to interconnect devices as called for in the plans, specifications, and manufacturers requirements. Furnish quality and grade of cable capable of being operable at up to twice the distance installed on this project. Furnish cabling meeting all manufacturers' requirements and all applicable standards for performance and safety.

### **31.3. CONSTRUCTION METHODS**

#### **A. General**

Furnish media access control (MAC) addresses for all equipment utilized as part of this project. Affix MAC Address label to each device utilized. Furnish IP addresses for all equipment utilized as part of this project. Affix final IP address each device utilized. Use labels that do not smear or fade.

In field equipment cabinets, fully integrate new Ethernet switches with the fiber optic interconnect centers. Integrate all field equipment as call for.



Fully integrate LAN to accomplish local device failover and fault tolerance.

Fully integrate LAN equipment to provide virus protection, user authentication, and security functions to prevent unauthorized users and data from entering the LAN.

### **B. Requirements Definition Document**

Prior to commencing work, the Contractor shall request from the Engineer a copy of the "IP/Ethernet Communications Plan Document" (prepared by Kimley-Horn and dated May 2016) as a reference to develop a Requirements Definition Document (RDD) that will form the basis for the overall network architecture and design. The RDD shall include:

- Text describing the proposed implementation of the access, distribution and core layers for the network as described in the Plans and these Project Special Provisions
- Table of IP addresses to be assigned to each device within each node based on the IP scheme in the "IP/Ethernet Communications Plan Document"

The RDD shall be prepared and signed by a qualified networking professional (minimum CCNA or a manufacturer-approved equivalent based on the approved hardware vendor) and will be approved by the Engineer. The Qualified network professional will be present during the installation and testing of the local area network as well as during system testing.

### **C. LAN Integration**

Fully integrate field, core, and network switches to form a complete local area network for communications between the TOC, fiber termination point, and each field device.

Fully integrate switches and firewall with computer and central system hardware to form a complete local area network that allows users from the TOC as shown on the block diagram in the Plans to access applications on application servers. Fully integrate network to allow the notebook computer users to be able to connect to the network via the LAN port on the notebook computer using a network cable.

Fully integrate LAN equipment to provide virus protection, user authentication, and security functions to prevent unauthorized users and data from entering the signal system LAN.

All cables for each piece of hardware installed shall be clearly labeled, using a label convention approved by the Engineer. All cabling shall be manufacturer assembled and without any adapters, unless otherwise approved by the Engineer.

### **D. Network Performance Management Software**

Install and fully integrate the network performance management and remote monitoring software on the workstation being installed at the Division 6 Office and on two workstations being installed at the TOC.

### **E. Field Ethernet Switch**

Prior to installation of any field Ethernet switches, the Engineer shall approve the Contractor's desired mounting method and mounting location of the switch in the signal cabinet or CCTV cabinet. Should the Contractor need to modify the approved mounting method and location at a cabinet, notify the Engineer prior to installation for approval of the alternate mounting method or location.

Install and integrate all field Ethernet switches at field locations as depicted in the diagrams and tables and called for in these Project Special Provisions. Integrate with signal controller, conflict monitor, CCTV camera (if present), and existing fiber optic communications.

Furnish SMFO jumpers that are a minimum of 3 feet in length with the appropriate type of factory assembled connectors on each end. Ensure that SMFO jumpers meet the operating characteristics of the SMFO cable with which it is to be coupled.

Provide inline surge protection for all Ethernet connections in field cabinets.

#### **F. Core Ethernet Switch**

Install a core Ethernet switch in the Division 6 Office. Integrate the core Ethernet switch with the existing fiber optic cable terminations, using new jumper cables to maintain the existing communications architecture and topology. Route cables in existing overhead raceways.

Fully configure switch with performance monitoring software and operating system software/firmware. Furnish SMFO jumpers with the appropriate type of factory assembled connectors on each end. Ensure that SMFO jumpers meet the operating characteristics of the SMFO cable with which it is to be coupled.

Configure and test all Ethernet equipment prior to installation.

#### **G. Network Ethernet Switch**

Install the network Ethernet switch in the TOC and integrate with all application servers and the core Ethernet switch.

Fully configure switch with performance monitoring software and operating system software/firmware. Furnish SMFO jumpers with the appropriate type of factory assembled connectors on each end. Ensure that SMFO jumpers meet the operating characteristics of the SMFO cable with which it is to be coupled.

Configure and test all Ethernet equipment prior to installation.

### **31.4. MEASUREMENT AND PAYMENT**

(\_\_\_\_) *Ethernet Switch* will be measured and paid as the actual number furnished, installed, integrated, and accepted. All SFP modules, optics, cabling, attenuators, configuration, and testing or other labor or materials required to install and integrate the Ethernet Switch will be considered incidental and not be paid for separately.

*Network Performance Management Software* will be paid at the contract lump sum price. This shall include furnishing, installing, configuring, and testing the software.

LAN Integration will be measured and paid as a lump sum. LAN integration includes configuration and integration of all LAN hardware, firmware, software, and VPN firewall to complete the LAN architecture, and submittal of the RDD. All cabling, hardware, patch panels, accessories, labor, and materials required to make the unit function as part of this project shall be considered incidental and not paid for separately. Partial payments for this item will be made on the following schedule: 20% upon completion and acceptance of the RDD; 20% upon installation, integration and acceptance of LAN equipment, 40% upon installation, integration and acceptance of

LAN equipment at Routing Switch locations, and 20% upon installation, integration and acceptance of the entire project furnishing of and acceptance of network as-built documentation.

No separate payment will be made for cable routing within building as this will be considered incidental to equipment installation and integration.

Payment will be made under:

<b>Pay Item</b>	<b>Pay Unit</b>
Field Ethernet Switch.....	Each
Core Ethernet Switch .....	Each
Network Ethernet Switch.....	Each
Network Performance Management Software.....	Lump Sum
LAN Integration.....	Lump Sum

## 32. SYSTEM SOFTWARE

### 32.1. DESCRIPTION

Upgrade the following existing software:

- Distributed Processing System Software
- CCTV Control Software

Install the following software as furnished by the Engineer.

- Local Controller Software (latest IP version of NCDOT's state-licensed ASC/3-2070 software package). The Engineer will furnish the latest version of the software at the time of burn-in. Request the software from the Engineer a minimum of five business days prior to burn-in.

**The Contractor shall be responsible for the development of and integration of all system graphics (and associated system devices) described in the following specifications.**

### 32.2. MATERIAL

#### A. General

Provide a perpetual, irrevocable software license to the Department and the City of Fayetteville that gives them the right to copy and use all software furnished or upgraded with this project at any facility within the signal system limits.

Furnish software that may be used at the TOC, or at any other offices in the State of North Carolina that the City and State, or their authorized agent, may establish for the purpose of traffic signal monitoring and control of the Fayetteville Signal System.

Provide any third party software licenses to the Department and the City of Fayetteville for software that may be used. Example: report-configuring, diagnostic, or monitoring software.

#### B. Distributed Processing System Software

##### 1. General

The current central signal system software at the Fayetteville TOC is Econolite Centracs. Upgrade the current software to support IP/Ethernet communications with traffic signals. Ensure that all settings and databases remain unchanged during the upgrade process.

All changes to the system, including adding new controllers, configuring communications, modifying maps and intersection displays, etc., shall be performed through the system graphical user interface or by updating files in the system software folders. The use of initialization files and external editors shall not be required.

##### 2. Database Preparation

The Department and City will perform all database conversions necessary for the new local controller software. Request each database from the respective signal owner at least seven (7) calendar days prior to installation in the signal controller.

Complete all data entry necessary to implement the operation of the system software.

The Engineer (by way of the City or Division 6 Traffic Services) will furnish intersection timing information and coordination parameters (cycle, split, offset). Any custom intersection displays will also be provided by the Department or City. Otherwise, default intersection timing data and standard intersection maps will be utilized when configuring intersections onto the system. Program all system detectors shown in the plans. Coordinate with the City to provide setup, naming/labeling, logging and any features required for the operation of all system detectors.

TOD/DOW/DOY plans, alarms and other information for the operation of the signal system shall be entered by the contractor.

### **3. System Graphics**

All graphics for system maps, control section maps, and intersection displays shall be submitted to the Engineer for approval before being integrated with the software.

### **4. Intersection Display**

The Contractor shall be responsible for the development of and integration of all system graphics (and associated system devices) described in the following specifications.

The intersection graphics shall display both static and dynamic information. The static information shall include the intersection name, geometrics of the intersection (including a graphic display of the number of lanes and their associated use), adjacent land use, the location of the controller, and a layout of the intersection with the intersections signal locations and number of heads. The dynamic information to be displayed shall include:

- All vehicle signal indications for each active phase, and up to sixteen (16) overlaps with red, yellow, and green indicators
- All pedestrian signal indications, for up to sixteen (16) active phases. WALK, flashing DONT WALK, and steady DONT WALK shall be shown
- Vehicle and pedestrian detector actuations for each active phase
- Cycle timer (central and local clocks)
- Timing plan in effect (with cycle length and offset)
- Operational status of the intersection shall include the following, but not be limited to:
  - Timing in effect (in coordination, TOD, TR, etc.)
  - Status mode (transition, free operation, flash, pre-emption (railroad or emergency vehicle))
  - Control mode (manual control, local control, failed, etc.)

The intersection display shall accommodate all phasing of the state-licensed local controller software.

The intersection display shall be capable of being dynamically sized by a workstation user. Resizing the window shall not reduce the amount of data displayed on a workstation monitor.

### **C. CCTV Control Software**

Integrate the City-provided Econolite Advanced CCTV module within the current signal system software. The CCTV module shall support the viewing of digital video streams from the CCTV cameras installed under this Project and shall support the viewing of video stream on the new video

wall in the TOC. Ensure that the pan-tilt-zoom (PTZ) functionality is operational and that all CCTV cameras installed under this Project can be panned, tilted, and zoomed by an operator in the Fayetteville TOC.

### **32.3. CONSTRUCTION METHODS**

#### **A. General**

Fully integrate the distributed processing signal system software on the Distributed Processing Signal System Server and Communication Server called for in these Project Special Provisions. Fully integrate the distributed processing signal system software on each workstation in the TOC and Division 6 Office.

Fully integrate the CCTV central software on the CCTV Server called for in these Project Special Provisions. Fully integrate the CCTV software on each workstation in the TOC and Division 6 Office.

Register all software products furnished with this project with the software supplier. The City of Fayetteville and the NCDOT shall be identified as the registered owner of all software.

#### **B. Local Controller Software**

Install NCDOT-furnished local controller software on all new controllers. Use the latest version available at the time of installation as directed by the Engineer. Request local controller software from Engineer a minimum of one (1) week prior to use of software during burn-in period.

**All controllers in the final Signal System shall have identical local software.**

#### **C. Distributed Processing System Software**

Integrate the distributed processing traffic control applications software and all other software with the communications system and local controllers to provide a traffic signal system that provides the functionality required by these Project Special Provisions.

Load all parameters necessary to implement coordinated signal operations. The Engineer will furnish the timing parameters in standard traffic engineering format (cycle, split, and offset) prior to the initiation of the 60-day observation period. Make any modifications to the cycle, split, and offset information furnished by the Engineer that are necessary to implement the timing plans into the system database. The test period may not begin until the timing parameters have been loaded. The Engineer may, at his/her option, observe the loading of the timing plans.

As directed by the Engineer, make modifications to the coordinated signal timing parameters (cycle, split and offset) prior to system acceptance to improve system coordination and efficiency. The Engineer will furnish the parameters to be modified by the Contractor. Make these modifications at no additional cost. No timing plan changes will be required after the successful completion of the system operational test (as approved by the Engineer).

Prepare comprehensive, detailed graphic displays for the system display, for all control section displays, and for all intersection displays. Contractor shall install all displays and fully integrate with system software. **Submit all graphics to the Engineer for approval prior to the System Operational Test and prior to integration in the software.**

#### **D. CCTV Control Software**

Integrate the CCTV system software with all new CCTV cameras that are shown in the Plans.

**32.4. MEASUREMENT AND PAYMENT**

*Upgrade \_\_\_ Software* will be paid at the contract lump sum price. This shall include the upgrading, testing, and all materials, 3rd party software for reporting, equipment, labor, tools, storage, shipping, and incidentals necessary to upgrade the existing software, complete system integration, and provide a complete operating system. Partial payment for this item will be made as follows: 50% of the lump sum price upon upgrade and configuration of the software and 50% of the lump sum price upon successful completion of the Observation Period. No payment will be made for providing software license as required in these Project Special Provisions.

All other software and hardware otherwise required to accomplish the functionality required by the Project Special Provisions will not be paid for separately but will be considered incidental. No payment will be made for providing software license and source code as required in these Project Special Provisions.

No measurement will be made for the installation of the NCDOT-provided local controller software on new controllers, as this will be considered incidental to Controller with Cabinet pay item.

Testing will not be paid for separately but will be considered incidental to equipment installation.

Payment will be made under:

<b>Pay Item</b>	<b>Pay Unit</b>
Upgrade Signal System Software .....	Lump Sum
Upgrade CCTV System Software .....	Lump Sum

**33. COMPUTER HARDWARE****33.1. DESCRIPTION**

Furnish and install server computers and workstation computers at the Fayetteville TOC and NCDOT Division 6 Office with all software and hardware to provide fully operational computing platforms and systems to accomplish the operational requirements of the computerized signal system.

Install and integrate all computer hardware as shown in the Block Diagram contained in the Plans.

**33.2. MATERIAL****A. General**

Furnish hardware that operates at 115 VAC  $\pm$  10 percent at 60 Hz. Furnish hardware that operates in a +40 to +122 degree Fahrenheit environment at 20 to 80 percent relative humidity.

All workstations and servers shall be from the same manufacturer. Servers and workstations that use proprietary power supplies will not be accepted.

Furnish all software licenses, compact discs, manuals, and documentation for all software installed on computers furnished under this project.

For installations routing cables inside buildings, utilize existing cable raceways, electrical boxes, and metallic conduit where feasible.

**B. Distributed Processing Signal System Server**

Furnish Distributed Processing Signal System server (herein referred to as the "Signal System Server") to host the signal system central software on a client/server environment over the Fayetteville Signal System LAN.

The server shall have the following minimum features:

- Processor: Dual CPUs, Intel Xeon E5-2640 or equivalent
- Memory: 16 GB
- RAID Configuration: RAID 5 (3-16 HDDs or SSDs), hot swappable
- RAID Controller: 1 GB NV Cache
- Hard Drives: 4 x 300 GB
- Network: Two 10/100/1000 network interface cards
- Optical Drive: Internal DVD+/-RW
- Rack mountable in standard EIA 19" equipment rack



The operating system for the Signal System Server shall be Microsoft Windows Server 2012 or newer. The release used shall be the latest revision available as recommended by the supplier of the system software.

The Signal System Server shall be furnished with all necessary software required to operate the signal system properly, which includes Microsoft® SQL Server 2012 R2 or other version compatible with the signal system software and approved by the Engineer, and all applicable licenses.

### **C. Distributed Processing Signal System Communications Server**

Furnish a Distributed Processing Signal System Communications Server (herein referred to as the “Communications Server”). Furnish Communications Server that is equipped with all hardware and software required to meet all of the data communications requirements, including once-per-second polling of all traffic signal controllers.

The server shall have the following minimum features:

- Processor: Dual CPUs, Intel Xeon E5-2640 or equivalent
- Memory: 8 GB
- RAID Configuration: RAID 1 (two 100 GB HDDs)
- RAID Controller
- Hard Drive: 100 GB
- Network: Two 10/100/1000 network interface cards
- Optical Drive: Internal DVD+/-RW
- Rack mountable in standard EIA 19” equipment rack

The operating system for the Communications Server shall be Microsoft Windows Server 2012 or newer. The release used shall be the latest revision available as recommended by the supplier of the system software.

### **D. CCTV Video Server**

Furnish CCTV Video Server (herein referred to as the “Video Server”) to host the CCTV video system central software on a client/server environment over the Fayetteville Signal System LAN.

The server shall have the following minimum features:

- Processor: Dual CPUs, Intel Xeon E5-2640 or equivalent
- Memory: 32 GB
- RAID Configuration: RAID 5 (3-16 HDDs or SSDs), hot swappable
- RAID Controller: 1 GB NV Cache
- Hard Drives: 4 x 300 GB
- Network: Two 10/100/1000 network interface cards

- Optical Drive: Internal DVD+/-RW
- Rack mountable in standard EIA 19" equipment rack

The operating system for the Signal System Server shall be Microsoft Windows Server 2012 or newer. The release used shall be the latest revision available as recommended by the supplier of the system software.

#### **E. Remote Access Server**

Furnish Remote Access Server to host remote access software and allow up to eight simultaneous users to access all services on the LAN via Ethernet connection. Furnish minimum six client licenses of remote access software.

Furnish Remote Access Server with same features as the Signal System Server.

Furnish remote access server with remote access software with the following features:

- Support of up to 8 simultaneous users initially with expansion capability of up to 12 simultaneous users
- Provision of each user with a Windows desktop with access to all applications and services on the TOC LAN at their remote location. When logged into remote access server, upon providing username and password, remote user shall be provided with a Windows desktop on their remote computer.
- Client software that is fully functional on all currently supported versions of MS Windows (version Windows 7 and later)
- Allows remote user to access all drives on servers on the LAN and transfer files between their remote station and server on the LAN through windows file access methods such as Windows Explorer
- Supports remote user automatic reconnection if communication connection is lost
- Supports use of client remote access configuration by means of standard windows, menu driven interface.
- Shall support all services available over the LAN (including printers and servers)
- Shall require no more than 64 Mb of RAM to support each user
- Provide security and user authentication features and functionality
- Utilize Windows Remote Desktop functionality or approved equal.

Furnish server with all required operating system and third party support software to fully operate remote access server.

#### **F. Backup Storage Server**

Furnish Backup Storage server to provide backup and restore functionality of the hard-drive(s) in the Signal System Server.

Furnish Backup Storage Server that has the same features as the Signal System Server.

### **G. Keyboard Video Mouse Switch**

Furnish Keyboard-Video-Mouse (KVM) switch that allows a single keyboard, mouse, and RGB monitor to access and switch between multiple application servers in the rack cabinet. Furnish KVM switch unit that has the following features:

- Rack mountable with a maximum height of 1.75 inches
- Control of a minimum of 8 servers using a single unit
- Multiple switching methods including front panel, keyboard, or on-screen display
- Compatible with servers furnished under this project
- Includes keyboard, monitor, and pointing device

Furnish all necessary cabling to integrate KVM switch.

### **H. Computer Workstations**

Each microcomputer workstation shall be upgradeable and shall meet the following minimum requirements:

- Processor: Intel Xeon E5-1603
- Memory: 8 GB
- Hard Drive: 250 GB
- Network: 1 GB network interface card
- Video: 2.0 GB NVIDIA Quadro NVS 510, or equivalent, that can drive 4 video displays
- Optical Drive: Internal DVD+/-RW
- Provide dual (2) flat screen monitors and required video cables. Minimum monitor size shall be 20", 18.5" viewable with a 1,600 × 1,200 resolution
- Mini-Tower chassis
- Microsoft 2-button/scroll mouse
- Full function, 104 keyboard with separate numeric and cursor control keys
- Speakers
- A minimum of four (4) universal serial bus (USB) ports
- Stand-alone UPS unit, with a minimum
  - Surge protection and filtering
  - Battery capable of providing 6 minutes of backup time at full load

- Three (3) NEMA 5-15R output connections (with battery backup)
- Three (3) NEMA 5-15R output connections (with surge protection)

The operating system for the signal system workstation(s) shall be Microsoft Windows 7 Professional or newer. The release used shall be the latest revision available as recommended by the supplier of the system software. Install antivirus software.

The operating system shall provide for true multi-tasking and graphical user interface. It shall be possible for workstation users to run Windows-based programs in one or more windows while the traffic signal system applications software continues in full operation.

### **I. Surge Suppression Strips**

All computer hardware and peripherals not connected to an Uninterruptible Power Supply (UPS) shall be connected to a surge suppression power strip. Provide surge suppression power strips equipped with an on-off switch, an indicator lamp, isolating filter banks, and a minimum of six (6) 120 VAC, 60 Hz outlets. At a minimum, the filter banks shall attenuate high frequency noise

### **J. Equipment Rack Cabinet**

Furnish equipment cabinets with railings and sockets for mounting of EIA 19" mountable equipment. Furnish units with removable and adjustable shelves and pull out drawers capable of holding 1.5 times the heaviest component required to be placed on shelf or drawer (when fully extended). Furnish Rack cabinets that are modular with removable side panels with open front and back sections. Furnish racks with cable management and raceways to facilitate neat and orderly organization of all cables routed to equipment on the rack. Furnish rack cabinets with accessories to ensure cables are not kinked or pinched and that all minimum bend radii of cables are preserved. Furnish rack cabinet units that may be aggregated into single units of up to four bays wide. Furnish units made of quality, non-corrosive materials and non-peeling paint.

Furnish equipment rack cabinets for installation within buildings as shown in the Plans. Furnish units with ventilation fans audible no more than 46 dba at a distance of 4 feet from the unit. Furnish units with each bay a width of no more than 24" and a minimum of 84" of continuous useable rack space beginning no more than 6" above the floor.

### **K. Uninterruptible Power Supply**

Furnish UPS units that are capable of detecting a power failure and providing back-up power to the listed components within twenty (20) milliseconds. The transition to the UPS source from primary power shall occur without loss of data or damage to the equipment being provided with back-up power.

Furnish UPS units that are sized such that each is capable of providing back-up power for the total load of all equipment connected to the UPS plus an additional load of twenty-five percent of the total load for at least thirty (30) minutes of operation. The UPS units shall be capable of interfacing with the Distributed System Software such that upon sensing a loss of power, a system shutdown can be initiated and completed within the specified UPS span of operation.

The UPS unit shall include:

- Commercial 115 VAC, 60 Hz power interconnection and power loss sensing and alarm report via the Distributed System Software

- Power protection and filtering
- Power conversion for battery charging
- Batteries to support thirty (30) minutes of operation with loss of power
- Battery status sensing and low battery alarm reporting via the System Software
- Battery charging and charge management
- Battery power conversion and filtering as necessary for interface compatibility with installed equipment

UPS units shall be connected to commercial power. The UPS units and power interconnect shall comply with article 645 of the National Electric Code (NEC).

### **33.3. CONSTRUCTION METHODS**

#### **A. General**

Furnish and install the central hardware required to support the software functions called for in these Project Special Provisions.

Furnish and install the hardware as shown in the block diagram in the Plans.

Whenever possible, use existing cable raceways, ducts, raised floors, and drop ceilings to route cables.

All computer hardware called for in this section shall be installed, integrated, and in use within sixty (60) days of date of purchase. Provide receipt with purchase date to Engineer during hardware installation. Any hardware older than sixty (60) days may be integrated and put in use at the sole discretion of the Engineer.

All cables for each piece of hardware installed shall be clearly labeled, using a label convention approved by the Engineer. All cabling shall be manufacturer assembled and without any adapters, unless otherwise approved by the Engineer.

#### **B. Distributed Processing Signal Server**

Install distributed processing signal system server into new equipment rack cabinet in the Division 6 Office. Integrate with core Ethernet switch, KVM switch, and rack cabinet power source. Integrate with signal system communications server using direct serial, parallel, USB, or network connection. Fully configure server to operate distributed system processing software. Integrate with backup storage server to support scheduled and on-demand backup of data.

#### **C. Signal System Communications Server**

Install signal system communications server into new equipment rack cabinet in the Division 6 Office. Integrate with core Ethernet switch, KVM switch, and rack cabinet power source. Fully configure server and ports to facilitate signal system communications.

#### **D. CCTV Video Server**

Install video server into new equipment rack cabinet in the Division 6 Office. Integrate with core Ethernet switch, KVM switch, and rack cabinet power source.

**E. Remote Access Server**

Install remote access server into new equipment rack cabinet in the Division 6 Office. Integrate with core Ethernet switch, KVM switch, and rack cabinet power source.

Install and configure software with usernames, passwords, and Remote Access Windows desktop that allows client user gaining access to the LAN via the server, has complete access to all software applications on the LAN, available to a local user. Install all third party software and drivers required to create fully functional remote access server.

**F. Backup Storage Server**

Install backup storage server into new equipment rack cabinet in the Division 6 Office. Integrate with core Ethernet switch, KVM switch, and rack cabinet power source.

Integrate with distributed processing signal server to support scheduled and on-demand backup of data.

**G. Keyboard Video Mouse Switch**

Install KVM switch into new equipment rack cabinet in the Division 6 Office. Integrate with all application servers and rack cabinet drawer monitor, keyboard, and mouse.

**H. Computer Workstations**

Install four (4) computer workstations with dual monitors at the Fayetteville TOC as shown in the Plans. Integrate with network Ethernet switch. Fully configure microcomputer workstation with all client software to operate all signal system subsystems including distributed processing signal system and CCTV subsystem. Integrate one of the video card outputs of each workstation with the new video wall system.

Install one (1) computer workstation at the NCDOT Division 6 Office as shown in the Plans. Integrate with network Ethernet switch. Fully configure microcomputer workstation with all client software to operate all signal system subsystems including distributed processing signal system and CCTV subsystem. Integrate one of the video card outputs with the new LCD video monitor.

Configure Windows Remote Desktop on the workstation so that a user can remotely connect to each application server on the LAN and be presented with the same graphical user interface as if they were locally connected to the server.

**I. Surge Suppression Strips**

Furnish and install surge suppression power strips for all computer hardware and peripherals, video subsystem, local area network, and central communications equipment not connected to a UPS.

**J. Rack Cabinets**

Install new rack cabinets in the Division 6 Office and Fayetteville TOC as shown in the Plans. Install full rack cabinets such that access to both the front and back of cabinet is available. Route cabling in cabinets using raceways. Bolt the cabinets to the floor to prevent any rack from falling over if loaded in a top-heavy manner.

**K. Uninterruptible Power Supply**

Install uninterruptible power supply (UPS) units in the top of each new equipment rack cabinet to supply uninterrupted power in the event of a failure of primary power to supply 30 minutes of backup power for all devices that will ultimately populate the rack bay under this project. Integrate with equipment in rack bay. Configure UPS unit servicing the signal system server to provide the alarm notifications detailed above.

**L. Computer Hardware Integration**

Fully integrate computer hardware equipment to form complete and operational systems as called for in these Project Special Provisions and shown on the block diagram in the plans. Install and configure all central computer hardware at the Fayetteville TOC and NCDOT Division 6 Office to accomplish the functionality called for in these Project Special Provisions and hardware functionality required to support the computer software to be installed on to the computing hardware called for under this project. Integrate with LAN equipment and field equipment.

Prior to installing and configuring the computer hardware at each facility, develop a computer hardware architecture and system design document that shows the entire layout of the computer hardware systems and their interconnection. The function, description, and model number of each computer hardware component will be shown in the document. The report will describe the network topology in text and using graphics.

**33.4. MEASUREMENT AND PAYMENT**

(\_\_\_\_) *Server* will be measured and paid as the actual number furnished, installed, integrated, and accepted.

*KVM Switch* will be measured and paid as the actual number furnished, installed, integrated, and accepted.

*Computer Workstation* will be measured and paid as the actual number furnished, installed, integrated, and accepted.

*Rack Cabinet* will be measured and paid as the actual number furnished, installed, integrated, and accepted. UPS units shall be considered incidental and shall not be paid for separately.

*Computer Hardware Integration* will be measured and paid as a lump sum price. This item shall include the installation, testing, and all materials, equipment, labor, tools, storage, shipping, and incidentals necessary to install and make fully operational the computer hardware equipment at the TOC. Partial payment for this item will be made according to the Sequence of Construction as follows: 40% of the lump sum price upon completion of Phase 2, 40% of the lump sum price upon completion of Phase 3, and 20% of the lump sum price upon completion of Phase 10.

All cabling, labeling, sockets, outlets, conduit, cable routing, or other accessories required to configure, integrate, and interconnect computer equipment shall be considered incidental and shall not be paid for separately. This shall include provision of the surge suppression power strips.

Payment will be made under:

<b>Pay Item</b>	<b>Pay Unit</b>
Distributed Processing Signal System Server.....	Each
Signal System Communications Server.....	Each
CCTV Video Server.....	Each
Remote Access Server .....	Each
Backup Storage Server.....	Each
KVM Switch.....	Each
Computer Workstation.....	Each
Rack Cabinet.....	Each
Computer Hardware Integration .....	Lump Sum



**34. CENTRAL VIDEO SYSTEM****34.1. DESCRIPTION**

Provide the central video hardware and/or software at the Fayetteville TOC and NCDOT Division 6 Office necessary to control and monitor the closed circuit television (CCTV) cameras installed at locations shown in the Plans.

**34.2. MATERIAL****A. General**

All central video equipment shall operate at 115 VAC (+/- 10 percent) at 60 Hz (+/- 10 percent). The equipment shall operate in a +32 to +120 degree F environment at 20 to 80 percent relative humidity.

**B. Video Wall System****1. General**

Furnish a new video wall for the Fayetteville TOC to replace the existing wall monitors. The video wall shall be a fully integrated system of monitors and hardware and/or software. The monitors shall be arranged in a matrix that is three (3) rows high by five (5) columns wide for a total of fifteen (15) monitors.

**2. Monitors**

The monitors of the video wall shall meet the following minimum requirements:

- Size: 46" monitor/tile
- Active screen area: 40.1 inches by 22.5 inches
- Outer dimensions: 40.24 inches by 22.7 inches by 3.6 inches
- Technology: commercial grade direct view LCD
- Resolution: 1920x1080
- Aspect ratio: 16:9
- Contrast ratio: 3500:1
- Response time (white to black): 8 ms
- Refresh rate: 60 Hz
- Full viewing angle: 178 degrees (vertical and horizontal)
- Luminance: 2 brightness levels available; 500-800 cd/m<sup>2</sup>

- Backlight technology: LED
- Backlight life: at 1/2 brightness, 50,000 hrs
- Acoustic noise: fanless operation
- Advanced cooling system for 24/7 operations
- Bezel width: max of 5.5mm
- Display control: IR, RS-2332
- Orientation: portrait and landscape
- Automatic color and brightness calibration
- Inputs: HDMI
- Power consumption: 160 watts
- Internal or external power supply

### **3. Mounting System**

Furnish a wall-mounted frame for securing monitors in place and routing cables.

### **4. Management**

The Contractor shall provide a solution to scale video across the entire video wall or any section of the video wall.

The video wall system shall meet the following functionality:

- Creation of customized layouts using drag-and-drop configurations in the graphical user interface
- Ability to display a video feed on a single monitor (full-screen) or across multiple monitors
- Ability to display multiple video feeds on a single monitor, up to a 4x4 grid
- Ability to interface with the CCTV module of the signal system software for selecting layouts and video feeds
- Ability to act as an additional monitor output for any of the workstations in the TOC

### **5. Video Wall Processor**

Furnish a video wall processor unit that is a client of the CCTV video server and capable of processing all video inputs from the workstations and all video outputs to the wall monitors. Furnish unit with the following minimum specifications:

- Rack mountable with a maximum height of 6 RU
- Operating system of Microsoft Windows 7, and compatible with operating system of the video server installed under this project

- Intel Core i7 3.4 GHz (or greater) processor
- Minimum of 8 GB of RAM
- Minimum of 16 video display outputs with a resolution of 2560 x 1600 at 60 Hz
- Minimum of 4 video inputs that are HDMI or DVI
- 10/100/1000 MB network interface card

**C. LCD Video Monitors**

Furnish new 70" LCD video monitor for a 24/7/365 environment at the Division 6 Office.

LCD Video Monitor shall be UL listed, FCC Part 15 compliant, and shall meet FCC Class A or Class B device requirements, and Bellcore GR-1089-CORE electromagnetic compatibility requirements. Equipment shall meet the following specifications, standards, and subparts as applicable.

All video monitor equipment shall have any safety handling related instructions plainly marked on its case.

All switches, indicators, and connectors shall be clearly and permanently marked as to identity and function. Printed circuit boards shall have permanent markings, including a part number and functional name. Each removable module shall, as a minimum, include a permanently attached (e.g., stamped, etched, etc.) part number. Each removable module shall also include a permanently attached serial number. All component identifications shall correctly correspond to schematics, parts lists, and written narratives included in operation/maintenance manuals.

Display monitors shall provide the following features and functions at a minimum:

- 1280 x 768 native pixel resolution
- 16.7 million displayable colors
- Brightness of at least 450 candela per square meter
- Contrast ratio of 4,000:1 or better
- 16:9 aspect ratio
- One BNC or RCA connector for NTSC composite color video input
- One digital RGB DVI input
- One S-video input
- One Analog RGB computer UXGA video input
- RS-232 DB-9 interface control port

- Audio L/R stereo inputs and outputs
- Infrared remote control
- Switching between video inputs via remote control, on the monitor panel, or via serial port
- Horizontal and Vertical viewing angles of at least 175 degrees
- Swing-out articulating arm wall-mounting brackets

Each LCD video display monitor shall have a nominal operating temperature range of 5°C to +40°C and 20 to 80 percent relative humidity, non-condensing.

Each video display monitor shall weigh no more than 100 pounds without attachments/brackets and no more than 150 pounds with mounting brackets and tilting hardware.

Each LCD video display panel shall operate from 115 V +/- 10%, 60 Hz +/- 5% VAC input power. Power consumption shall be no more than 210W per display panel. Each video display panel shall be supplied with all the necessary hardware needed for mounting to wall or video wall units as directed by the engineer.

Furnish wall-mounting brackets (and all applicable hardware) for each LCD monitor that allow for the unit to be tilted. Ensure the wall-mounting bracket complies with the recommendations of the monitor's manufacturer and can be attached to the wall.

### **34.3. CONSTRUCTION METHODS**

#### **A. General**

Install and test all central video equipment in accordance with the manufacturer's recommendations. Furnish and integrate any manufacturer software not explicitly stated in these Project Special Provisions, but required for any central video equipment to provide full the stated functionality. Provide a copy of any installed manufacturer software to the Department.

Route all cabling in ceiling, floor, conduit, or cable raceways unless otherwise approved by the Engineer.

All cables for each piece of hardware installed shall be clearly labeled, using a label convention approved by the Engineer. All cabling shall be manufacturer assembled and without any adapters, unless otherwise approved by the Engineer.

#### **B. Video Wall System**

As shown in the Plans, install the video wall system in the Fayetteville TOC. Follow manufacture recommendations. Furnish cable raceways or wire molds of the same color as the wall

for the discrete placement of cabling.

**Prior to installation of the video displays, develop shop drawings and submit to Engineer for approval prior to commencement of installation of the units.**

Integrate the video wall system with the CCTV module of the signal system software.

**C. LCD Video Monitor**

Install one (1) 70” LCD video monitor on the wall in the NCDOT Division 6 Office as shown in the Plans. Insure that monitor is installed securely and in a fashion that allows for their removal for maintenance and access to monitor display controls. Connect, configure, and fully integrate the monitor with new workstation to display the signal system software interface and CCTV camera video. This includes installation of cabling and connection of monitor to power source.

**34.4. MEASUREMENT AND PAYMENT**

*Video Wall System* will be measured and paid as a lump sum price. This item shall include the installation, testing, and all materials, equipment, labor, tools, storage, shipping, and incidentals necessary to install and make fully operational the video wall system at the TOC. No separate measurement will be made for monitors, power supplies, cables, image processor hardware, configuration software, controllers, framing system, brackets, spacers, mounting hardware, cabling, and other materials required.

*LCD video monitor* will be measured and paid as the actual number furnished, installed, integrated, and accepted.

No direct measurement will be made for surge suppression strips. These will be considered incidental to the devices attached to them.

No direct measurement will be made for cabling used to interconnect devices within buildings including coaxial cabling, network cabling, serial cabling, and power cabling. These items will be considered incidental to the devices they are connected.

Configuration and integration of central video components will be considered incidental and shall not be measured separately.

Payment will be made under:

<b>Pay Item</b>	<b>Pay Unit</b>
Video Wall System .....	Lump Sum
LCD Video Monitor.....	Each

### 35. SYSTEM SUPPORT EQUIPMENT

#### 35.1. DESCRIPTION

Furnish signal system support equipment with all necessary hardware in accordance with the plans and specifications.

#### 35.2. MATERIAL

##### A. Signal System Support Equipment

Furnish new, unused signal system support equipment to the Engineer in the quantities shown below:

- Ten (10) 2070E signal controllers as installed and accepted under this project
- Ten (10) 2070-1E CPU modules as installed and accepted under this project
- Two (2) pole-mounted 336 cabinets as installed and accepted under this project
- Eight (8) base-mounted 332 cabinets as installed and accepted under this project
- Ten (10) DC isolators as installed and accepted under this project
- Ten (10) AC isolators as installed and accepted under this project
- Twenty (20) detector cards as installed and accepted under this project
- Ten (10) conflict monitors as installed and accepted under this project
- Ten (10) model 200 load switches as installed and accepted under this project
- Ten (10) surge protectors as installed and accepted under this project
- Ten (10) flasher modules as installed and accepted under this project
- Ten (10) flash transfer relays as installed and accepted under this project
- One (1) test cabinet and controller as specified below

##### 1. Test Cabinet/Controller

Furnish and install a test cabinet/controller at the TOC as shown in the Plans. The test cabinet shall include a 2070E controller in a Type 332 cabinet. The test cabinet shall include a full complement of detector amplifiers, switch packs, a conflict monitor, and one fiber optic field Ethernet switch. The test cabinet shall also contain two (2) AC Isolators and two (2) DC Isolators. The test cabinet and panel shall be fully labeled.

#### Construction

The test cabinet shall have a heavy-duty aluminum dolly base with heavy duty casters. The base shall accommodate a fully equipped base-mounted 332 cabinet/controller. A pole or pedestal shall be attached to the base to support a display panel, which shall be located beside the cabinet convenient for use by maintenance personnel. The panel shall have all indicators and switches on the front, and shall have a suitable aluminum enclosure. The panel shall be fully labeled.

#### Indicators

The panel shall contain indicators to display the outputs of all the cabinet's traffic signal load switches. Red, yellow, and green indicators shall be used to display the outputs of the traffic signal load switches. In addition, indicators shall be provided for four (4) pedestrian displays and four (4) special functions. The indicators shall use incandescent bulbs or LED's that are user replaceable.

### **Controls**

The panel shall be equipped with controls which are connected to simulate all of the inputs, for test purposes, to the controller which are not already accommodated by switches in the controller cabinet.

### **Harnesses**

The panel shall be connected to the controller cabinet by means of harnesses. The harnesses shall be concealed in the pedestal or pipe supporting the panel and shall enter the cabinet from the bottom.

### **Connection to System**

The test cabinet/controller will be connected to the system on dedicated communication channels. Furnish and install a jumper cable of sufficient length. This jumper cable shall be used to connect the test cabinet's fiber optic Ethernet switch to the communication system.

#### **B. Communication System Support Equipment**

Furnish new, unused communication system support equipment to the Engineer in the quantities shown below:

- Forty (40) factory connectorized hybrid (ST-LC) jumpers of three foot length as installed and accepted under this project
- Twenty (20) factory connectorized (ST-type) pigtailed of ten foot length as installed and accepted under this project
- Ten (10) fiber optic field Ethernet switches as installed and accepted under this project

#### **C. CCTV System Support Equipment**

Furnish new, unused CCTV system support equipment to the Engineer in the quantities shown below.

- Five (5) CCTV assembly as installed and accepted under this project

### **35.3. MEASUREMENT AND PAYMENT**

*Furnish 2070L Controller* will be measured and paid as the actual number furnished and accepted.

*Furnish 2070-1E CPU Module* will be measured and paid as the actual number furnished and accepted.

*Furnish Pole Mount 336 Cabinet* will be measured and paid as the actual number furnished and accepted.

*Furnish Base Mount 332 Cabinet* will be measured and paid as the actual number furnished and accepted.

*Furnish DC Isolator Card* will be measured and paid as the actual number furnished and accepted.

*Furnish AC Isolator Card* will be measured and paid as the actual number furnished and accepted.

*Furnish Detector Card* will be measured and paid as the actual number furnished and accepted.

*Furnish Conflict Monitor* will be measured and paid as the actual number furnished and accepted.

*Furnish Load Switch* will be measured and paid as the actual number furnished and accepted.

*Furnish Surge Protector* will be measured and paid as the actual number furnished and accepted.

*Furnish Flasher Module* will be measured and paid as the actual number furnished and accepted.

*Furnish Flash Transfer Relay* will be measured and paid as the actual number furnished and accepted.

*Furnish Test Cabinet and Controller* will be measured and paid as the actual number furnished and accepted.

*Furnish ST-LC Hybrid Jumpers* will be measured and paid as the actual number furnished and accepted.

*Furnish ST Pigtails* will be measured and paid as the actual number furnished and accepted.

*Furnish Field Ethernet Switch* will be measured and paid as the actual number furnished and accepted.

*Furnish CCTV Assembly* will be measured and paid as the actual number furnished and accepted.

Payment will be made under:

<b>Pay Item</b>	<b>Pay Unit</b>
Furnish 2070L Controller .....	Each
Furnish 2070-1E CPU Module .....	Each
Furnish Pole Mount 336 Cabinet .....	Each
Furnish Base Mount 332 Cabinet .....	Each
Furnish DC Isolator Card.....	Each
Furnish AC Isolator Card.....	Each
Furnish Detector Card .....	Each
Furnish Conflict Monitor .....	Each
Furnish Load Switch.....	Each
Furnish Surge Protector .....	Each



Furnish Flasher Module .....	Each
Furnish Flash Transfer Relay .....	Each
Furnish Test Cabinet and Controller .....	Each
Furnish ST-LC Hybrid Jumpers.....	Each
Furnish ST Pigtails.....	Each
Furnish Field Ethernet Switch .....	Each
Furnish CCTV Assembly .....	Each

## 36. TRAINING

### 36.1. DESCRIPTION

Provide training for the installation, operation and maintenance of the computerized traffic system.

### 36.2. MATERIAL

#### A. General

Provide training to properly install, operate, maintain, diagnose and repair each piece of equipment and the software associated with the system. Provide approved manufacturer's representatives or other qualified personnel to conduct training courses. Provide training for a total of fifteen (15) City and Department personnel.

#### 1. Submittal Requirements

At least thirty (30) days prior to commencement of the training course, submit the following to the Engineer for review and approval:

- Schedule of training session dates
- Detailed course curricula
- Draft training manuals and course handouts
- Resumes of all instructors

The Engineer may request modification to the submitted material

For all training programs, a staff of engineers, technicians, and maintenance personnel familiar with traffic signal systems will be the training participants. A "day" of training shall consist of training conducted between the hours of 8:30am and 4:30 pm. For each session, provide all training materials (manuals, notebooks, hand-outs, etc.) as specified in the Documentation Section of these Project Special Provisions.

Qualified instructors shall present all training courses, lectures, and demonstrations in person. The Engineer shall approve all instructors.

Unless otherwise specified, accommodate a minimum of fifteen (15) persons at each session. Limit all hands-on computer exercises to two participants per computer. Contractor shall furnish at no cost to the Department or City additional networked computers (equivalent to those furnished with the project) as necessary to maintain that ratio of two participants per computer.

Conduct all training courses at a location provided by the Contractor within the City of Fayetteville and at a time mutually agreed upon, but not later than the start of system acceptance testing. Provide training material, manuals, and other handouts to serve not only as subject guidance, but also as quick reference for use by the students. Deliver course material in reproducible form at least three (3) days prior to the course.

## B. Subject Areas

Provide the training sessions at the required durations as listed in the Table below. A more detailed description of the required content of each training session is provided in the following sections. As part of the Project Implementation Schedule, propose the time of occurrence of each such training schedule.

Subject	Minimum Duration
System Overview	½ Day
Traffic Control Center Computer Hardware	1 Day
Traffic Control Applications Software	1 Day
Signal Controller and Cabinet Assemblies (for Signal Timing Personnel and Maintenance Personnel)	2 Occurrences at 2 Days Each
Communications Hardware – Fiber Optic Ethernet Switches (Session 1)	1 Day
Communications Hardware – Wireless Radio Systems (Session 2)	1 Day
Central Communications, LAN Equipment, and Software	3 Days
CCTV Central and Field Equipment – System Maintenance (Session 1)	½ Day
CCTV Central and Field Equipment – System Operations (Session 2)	1 Day

## C. Required Content and Format

### 1. Traffic Control System Overview

This training session shall consist of a lecture and discussion on the overall. The purpose of the session is to provide an overview of the traffic control system. This training session shall have a minimum duration of one-half (0.5) day.

### 2. Traffic Control Center Computer Hardware

The training session shall consist of classroom training and workshops regarding the operation of each of the traffic control system hardware elements and the operator interface. Conduct training by experienced vendor personnel.

The first session shall involve the operation and maintenance procedures for each element of the traffic control system hardware. As part of this session, stress the precautions that must be observed when operating the equipment. As a minimum, cover the following subjects in this segment of the training session:

- Overview of equipment functions and interactions.
- Computer system operation; restart, cold start.

- Functional operation of the servers, Ethernet Control Center LAN and backup system (including maintenance, proper replacement, etc.)
- Workstation operation, maintenance, proper replacement, etc.
- Central communication operation.
- Troubleshooting and problem identification of equipment.
- Operating system, including network operating system
- Operating system commands, including loading and executing programs, and archiving data to the backup system
- Detection of abnormal conditions within the operating system and hardware
- File management and disk organization
- Techniques for creating and editing files, including those used for the traffic control system databases

This training sessions shall have a minimum duration of one (1) day (lectures and/or workshops).

### **3. Traffic Control Applications Software**

These sessions of training for NCDOT and City staff shall include a review of the basic theory and functional application and operation of the traffic control software supplied by the Contractor, including the interface between the application program and the microcomputer operating system. This training system shall include but not be limited to:

- Time-of-day operation and event scheduling
- Traffic responsive pattern selection algorithms
- Reporting capabilities
- Interactive database manipulation
- Theory and application of traffic responsive operation
- Special function features
- Development and modification of screens used in the graphics display
- Creation, placement and operation of the dynamic portions of the graphics display

This session shall include lecture and classroom exercises and shall have a minimum of duration of one (1) day. Course material shall include the software documentation and the system user's manuals.

#### 4. Signal Controller and Cabinet Assemblies

Hold two identical controller training sessions for maintenance personnel. Each of the identical training sessions shall consist of two (2) consecutive days. Conduct one of these training sessions prior to the installation of any new controllers and cabinets on the project.

Training for controllers and cabinets shall be integrated into a single session with training exercises for cabinets and training exercises for controllers running concurrently. Instructors from the controller vendor and instructors from the cabinet vendor shall be in attendance during all days of the session.

Controller-specific instruction during the session shall be taught by experienced vendor personnel who thoroughly understand both the traffic engineering aspects of signal timing and the entry of timing into the controller and internal TBC's. Cabinet-specific instruction during the session shall be taught by a field service specialist(s) employed by the manufacturer.

These three sessions include training for NCDOT and City traffic engineering, signal timing, and maintenance personnel on controller and internal TBC operation and cabinet assemblies.

The signal controller and cabinet assemblies session shall include, but not be limited to, the following:

- Review of the functional operation of the signal cabinet, including a discussion on each individual component of the cabinet that details its function, installation techniques, and normal operation.
- Formal classroom presentation of the functional operation of the 2070E controller.
- Review of proper cabinet wiring procedures.
- Review on installation of electrical components and surge protection for cabinets.
- Review on operation of signal monitor tester.
- Hands-on workshop on timing data entry for 2070E controller, including:
  - All local intersection timing parameters
  - All coordination timing parameters
  - All parameters and threshold levels associated with traffic responsive operation
- Formal classroom presentation and hands-on workshop on operation of local controller utility software.
- Review of proper installation, programming, and troubleshooting of conflict monitors.
- Review of proper installation, programming, and troubleshooting of detector cards and lead-in cable.
- Hands-on workshop wherein maintenance personnel will troubleshoot simulated controller and cabinet assembly faults to the component level.

## **5. Communications Hardware**

The training session shall consist of classroom training and workshops regarding the operation of each of the communications system hardware elements and the technician interface. Conduct training by experienced vendor personnel.

The first session shall involve the operation and maintenance procedures for the fiber optic Ethernet switches (field and central models). At a minimum, cover the following subjects in this segment of the training session:

- Overview of equipment functions and interactions.
- Initialization startup and restarting of hardware.
- Setup and configuration of hardware.
- Functional operation of the fiber optic Ethernet switches (including maintenance, proper replacement, etc.)
- Programming required functionality of Ethernet switches
- Troubleshooting and problem identification of equipment.

The second session shall involve the operation and maintenance procedures for the wireless radio systems. At a minimum, the second session shall consist of the following:

- Overview of equipment functions and interactions.
- Overview of setup and operation of any associated software.
- Initialization startup and restarting of hardware.
- Functional operation of the wireless radio systems (including maintenance of fiber optic Ethernet switches and antennas, integration with signal controller and cabinet, etc.)
- Troubleshooting and problem identification of wireless radio equipment.

Each of these two training sessions shall have a minimum duration of one (1) day (lectures and/or workshops).

## **6. Central Communications, LAN Equipment, and Software**

Provide a training session, conducted by experienced vendor personnel and consisting of both operation and maintenance training of the Central Communication and LAN Equipment for the signal system. As a minimum, this session shall include the following subjects:

- Present system topology
- Operational theory of IP/Ethernet communications
- Initial setup and configuration of core Ethernet switch
- Initial setup and configuration of network and field Ethernet switches

- Operational procedures for network performance management software
- Operational procedures for Ethernet switches
- Operational procedures for remote user operation
- Procedures for adding future devices to the network
- Troubleshooting procedures

Provide a workshop session to reinforce the lectures and demonstrate troubleshooting and problem identification of equipment to the component level as well as validation of communications.

This lecture/workshop training session shall have a minimum duration of three (3) days.

**7. CCTV Central and Field Equipment**

Provide two sessions for the CCTV central and field equipment training.

The first session shall review the maintenance of the CCTV equipment. The training shall address the preventative maintenance and troubleshooting procedures for all the field and central equipment.

This session shall consist of a mixture of lecture and hands-on workshops and shall have a minimum duration of one-half (0.5) days.

The second session shall address the operational theory and procedures of the CCTV system. This training shall be oriented towards users of the system. The training shall address the use of, but not limited to, the following devices:

- Video Server
- Camera control software
- Video wall system hardware and software

Include "hands-on" training workshop with a minimum duration of one (1) day as part of this session. The CCTV training sessions shall be presented by field service specialist(s) employed by the suppliers of the CCTV system components.

**36.3. MEASUREMENT AND PAYMENT**

*Training* will be paid for at the contract lump sum price.

Payment will be made under:

<b>Pay Item</b>	<b>Pay Unit</b>
Training.....	Lump Sum

## 37. TESTING AND ACCEPTANCE

### 37.1. DESCRIPTION

Test all equipment, cable and software furnished and installed under this Contract according to the Standard Specifications. Conduct testing in the presence of the Engineer. **The Department reserves the right to perform any inspections deemed necessary to assure that the equipment conforms to the requirements specified herein.**

Perform factory and field testing (both pre- and post-installation) on the controllers, cabinets, and related hardware.

Cable provided under this contract shall have been pre-tested in accordance with the EIA/TIA Fiber Optic test procedures and as required by Bellcore GR-20-CORE. Supply proof of successful testing, including documentation of test results.

### 37.2. CABLE TESTS

Prior to installation, provide cable manufacturer's attenuation and Optical Time Domain Reflectometer (OTDR) testing data for each reel of cable upon request.

After installation and splicing is complete, perform cable tests according to the *Fiber Optic Splice Centers* section of these Project Special Provisions.

### 37.3. EQUIPMENT TESTS

Cabinets and controllers shall be tested according to the *Controllers with Cabinets* section of these Project Special Provisions.

### 37.4. TRAFFIC SIGNAL SUBSYSTEM

After completion of the integration of traffic signals for each communications group into new signal system software conduct a minimum of a seven-day test of the traffic signal system hardware and that portion of the communications network serving the traffic signal subsystem.

### 37.5. INTERSECTION OPERATIONAL TESTS

The Department will conduct complete intersection inspections and operational tests for each project intersection. These inspections and tests will determine whether all the field equipment at each location is installed and permanently labeled properly, and that all functions are in conformance with the Contract Documents. The intersection operational tests will be a non-central controlled functional test of the local controller, including the time-base coordination, emergency vehicle preemption and railroad preemption functions, system detectors, and the full operation of the intersection. All work at the intersection except fiber optic cable installation and termination must be completed for the operational test. This work includes the installation of risers, conduit, junction boxes, conduit entrance into the existing foundation, fiber optic interconnect center, and fiber optic field Ethernet switch.

### 37.6. SYSTEM OPERATIONAL TEST

All equipment and software provided in this project shall be fully installed and operational prior to the start of the system operational test. These test procedures shall demonstrate that all equipment is fully integrated and operational, and is properly controlling the system.



Testing of the software and hardware at the TOC and NCDOT Division 6 Office shall include demonstrating proper operation based on these project special provisions. These tests shall also demonstrate the proper function of the CCTV surveillance system, including camera selection, pan/tilt/zoom functions, and remote monitoring of video images. These tests shall also demonstrate the proper operation of the new intersections on the graphics display system, the full functionality of the installed operator workstation, and demonstrating proper reception of video signals on the monitor and control panels.

Submit a System Operational test plan a minimum of sixty (60) days prior to the scheduled start of the test. The test plan will be reviewed by the Engineer, and either approve it or indicate changes that are required for approval. The Contractor shall then submit the revised test plan. This process shall be repeated until the Engineer is able to approve the test plan.

Provide an operational test matrix at least four weeks prior to the scheduled beginning of the system operational test. The test matrix shall include columns for a description of the test, a summary of the test procedures, a column with sufficient space for comments and a status (pass/fail) column.

Repair or replace any component or software module that fails the System Operational Test. Retest repaired or replaced component(s) or software module.

The testing shall include, but not be limited to, the following:

- Demonstration of all key functions of the distributed processing signal system software, including but not limited to:
  - Uploading and downloading of controller data
  - Remote access and paging
  - All monitoring functions
  - Detector logging
  - Signal monitor logging and uploading
  - Traffic responsive operations
  - Event scheduler
  - Security functions
  - Graphic displays
  - Reports
- Power failure recovery, auto re-boot, and start-up of the distributed processing signal system software
- Database access, modification, storage, and retrieval
- Database backup and restoration from archived backup

- Remote access to the signal system software and CCTV software
- Local Area Network operations including monitoring network status and individual field Ethernet switch status
- Demonstrate that all features of the CCTV central software operates as called for with all field equipment

### **37.7. OBSERVATION PERIOD**

A 60-day observation period shall begin upon the successful completion of the tests described in this Section of the Project Special Provisions as well as the correction of all known deficiencies, including minor construction items and punch-list items developed by the Engineer. During the observation period, the City or Department shall observe equipment and software operations to determine that all components of the signal system operate properly and function according to the requirements of the Plans and these Project Special Provisions over an extended length of time.

During the observation period, respond to failures of the Contractor's equipment within two (2) hours and make repairs within eight (8) hours. For items that pose a traffic safety hazard (such as a controller failure), make repairs within four (4) hours. If any failures affect major system components (as defined below) for more than forty-eight (48) hours, the Department shall suspend the observation period beginning when the failure occurred. Resume the observation period after successful repair or replacement of equipment or software. Failures that necessitate a redesign of any component or failures in any of the major system components exceeding a total of three (3) instances of like nature in any thirty (30) day period shall terminate the observation period. Once the redesigned component has been installed and/or the failures corrected, the observation period shall be restarted from zero with the approval of the Engineer.

The major system components are:

- Local controllers and cabinets
- Fiber Optic Communication Network, including field Ethernet switches
- System hardware and software
- CCTV System, including Video wall system
- Wireless Ethernet Radio System
- Local Area Network

A successful 60-day observation period shall consist of continuous operation with no more than a total of five (5) calendar days on non-operation due to mechanical, electrical, or other malfunctions.

The observation period shall be completed by the project completion date and prior to final acceptance of the project. The observation period shall not begin until all testing has been successfully completed and shall not begin without the approval of the Engineer.

### **37.8. FINAL ACCEPTANCE**

Final system acceptance is defined as the time when all work and materials described in the Plans and these Project Special Provisions have been furnished and completely installed by the

Contractor; all parts of the work have been approved and accepted by the Engineer; and successful completion of the 60-day observation period.

The project will be ready for final acceptance upon the satisfactory completion of all tests detailed in this Section of the Project Special provisions; the rectification of all punch-list discrepancies; the submittal of all project documentation; and the completion of all required training.

### **37.9. MEASUREMENT AND PAYMENT**

There will be no direct payment for work covered in this Section. Payment at the contract unit prices for the various items in the Contract will be full compensation for all work covered by this Section.

County : Cumberland

Line #	Item Number	Sec #	Description	Quantity	Unit Cost	Amount
<b>ROADWAY ITEMS</b>						
0001	0000100000-N	800	MOBILIZATION	Lump Sum	L.S.	
0002	4405000000-E	1110	WORK ZONE SIGNS (PORTABLE)	325	SF	
0003	4410000000-E	1110	WORK ZONE SIGNS (BARRICADE MOUNTED)	150	SF	
0004	4415000000-N	1115	FLASHING ARROW BOARD	2	EA	
0005	4420000000-N	1120	PORTABLE CHANGEABLE MESSAGE SIGN	2	EA	
0006	4430000000-N	1130	DRUMS	60	EA	
0007	4435000000-N	1135	CONES	40	EA	
0008	4445000000-E	1145	BARRICADES (TYPE III)	80	LF	
0009	4450000000-N	1150	FLAGGER	2,400	HR	
0010	4480000000-N	1165	TMA	2	EA	
0011	4510000000-N	SP	LAW ENFORCEMENT	1,200	HR	
0012	4516000000-N	1180	SKINNY DRUM	40	EA	
0013	7060000000-E	1705	SIGNAL CABLE	5,800	LF	
0014	7120000000-E	1705	VEHICLE SIGNAL HEAD (12", 3 SECTION)	17	EA	
0015	7132000000-E	1705	VEHICLE SIGNAL HEAD (12", 4 SECTION)	10	EA	
0016	7252000000-E	1710	MESSENGER CABLE (1/4")	38,200	LF	
0017	7279000000-E	1715	TRACER WIRE	41,300	LF	
0018	7300000000-E	1715	UNPAVED TRENCHING (*****) (1, 2")	2,100	LF	
0019	7300000000-E	1715	UNPAVED TRENCHING (*****) (2, 2")	28,500	LF	

County : Cumberland

Line #	Item Number	Sec #	Description	Quantity	Unit Cost	Amount
0020	7301000000-E	1715	DIRECTIONAL DRILL (*****) (1- 5" CONDUIT ENCASING 2 - 2" CONDUITS)	300 LF		
0021	7301000000-E	1715	DIRECTIONAL DRILL (*****) (1, 2")	400 LF		
0022	7301000000-E	1715	DIRECTIONAL DRILL (*****) (2, 2")	10,300 LF		
0023	7324000000-N	1716	JUNCTION BOX (STANDARD SIZE)	53 EA		
0024	7348000000-N	1716	JUNCTION BOX (OVER-SIZED, HEA- VY DUTY)	133 EA		
0025	7360000000-N	1720	WOOD POLE	2 EA		
0026	7372000000-N	1721	GUY ASSEMBLY	100 EA		
0027	7420000000-E	1722	2" RISER WITH WEATHERHEAD	26 EA		
0028	7430000000-N	1722	HEAT SHRINK TUBING RETROFIT KIT	8 EA		
0029	7432000000-E	1722	2" RISER WITH HEAT SHRINK TUBING	48 EA		
0030	7444000000-E	1725	INDUCTIVE LOOP SAWCUT	1,250 LF		
0031	7456000000-E	1726	LEAD-IN CABLE (***** (14-2)	13,500 LF		
0032	7516000000-E	1730	COMMUNICATIONS CABLE (**FIBER) (24)	103,500 LF		
0033	7516000000-E	1730	COMMUNICATIONS CABLE (**FIBER) (48)	800 LF		
0034	7528000000-E	1730	DROP CABLE	13,700 LF		
0035	7540000000-N	1731	SPLICE ENCLOSURE	35 EA		
0036	7541000000-N	1731	MODIFY SPLICE ENCLOSURE	50 EA		
0037	7566000000-N	1733	DELINEATOR MARKER	82 EA		

County : Cumberland

Line #	Item Number	Sec #	Description	Quantity	Unit Cost	Amount
0038	7575142200-N	SP	NEW ELECTRICAL SERVICE	3 EA		
0039	7575160000-E	1734	REMOVE EXISTING COMMUNICATIONS CABLE	2,100 LF		
0040	7575180000-N	1735	CABLE TRANSFER	10 EA		
0041	7684000000-N	1750	SIGNAL CABINET FOUNDATION	2 EA		
0042	7686000000-N	1752	CONDUIT ENTRANCE INTO EXISTING FOUNDATION	55 EA		
0043	7687000000-N	1752	MODIFY FOUNDATION FOR CONTROL- LER CABINET	4 EA		
0044	7696000000-N	1751	CONTROLLER WITH CABINET (***** (2070E, 332 BASE MOUNTED)	98 EA		
0045	7696000000-N	1751	CONTROLLER WITH CABINET (***** (2070E, 336S POLE MOUNTED)	8 EA		
0046	7708000000-N	1751	DETECTOR CARD (***** (2070L)	2,137 EA		
0047	7901000000-N	1753	CABINET BASE EXTENDER	295 EA		
0048	7901010000-N	1753	CABINET BASE ADAPTER	2 EA		
0049	7980000000-N	SP	GENERIC SIGNAL ITEM BACKUP STORAGE SERVER	1 EA		
0050	7980000000-N	SP	GENERIC SIGNAL ITEM CCTV VIDEO SERVER	1 EA		
0051	7980000000-N	SP	GENERIC SIGNAL ITEM CCTV WOOD POLE	13 EA		
0052	7980000000-N	SP	GENERIC SIGNAL ITEM COMPUTER WORKSTATION	6 EA		
0053	7980000000-N	SP	GENERIC SIGNAL ITEM CONTROLLER WITH CABINET AND AUX FILE (2070E, 332 BASE MOUNTED)	199 EA		

County : Cumberland

Line #	Item Number	Sec #	Description	Quantity	Unit Cost	Amount
0054	7980000000-N	SP	GENERIC SIGNAL ITEM CONTROLLER WITH CABINET AND AUX FILE (2070E, 336S POLE MOUNTED)	1 EA		
0055	7980000000-N	SP	GENERIC SIGNAL ITEM CORE ETHERNET SWITCH	1 EA		
0056	7980000000-N	SP	GENERIC SIGNAL ITEM DIGITAL CCTV CAMERA ASSEMBLY	50 EA		
0057	7980000000-N	SP	GENERIC SIGNAL ITEM DISTRIBUTED PROCESSING SIGNAL SYSTEM SERVER	1 EA		
0058	7980000000-N	SP	GENERIC SIGNAL ITEM FIELD EQUIPMENT CABINET	3 EA		
0059	7980000000-N	SP	GENERIC SIGNAL ITEM FIELD ETHERNET SWITCH	311 EA		
0060	7980000000-N	SP	GENERIC SIGNAL ITEM FURNISH 2070-1E CPU MODULE	10 EA		
0061	7980000000-N	SP	GENERIC SIGNAL ITEM FURNISH 2070L CONTROLLER	10 EA		
0062	7980000000-N	SP	GENERIC SIGNAL ITEM FURNISH AC ISOLATOR CARD	10 EA		
0063	7980000000-N	SP	GENERIC SIGNAL ITEM FURNISH BASE MOUNT 332 CABINET	8 EA		
0064	7980000000-N	SP	GENERIC SIGNAL ITEM FURNISH CCTV ASSEMBLY	5 EA		
0065	7980000000-N	SP	GENERIC SIGNAL ITEM FURNISH CONFLICT MONITOR	10 EA		
0066	7980000000-N	SP	GENERIC SIGNAL ITEM FURNISH DC ISOLATOR CARD	10 EA		
0067	7980000000-N	SP	GENERIC SIGNAL ITEM FURNISH DETECTOR CARD	20 EA		
0068	7980000000-N	SP	GENERIC SIGNAL ITEM FURNISH FIELD ETHERNET SWITCH	10 EA		
0069	7980000000-N	SP	GENERIC SIGNAL ITEM FURNISH FLASH TRANSFER RELAY	10 EA		

County : Cumberland

Line #	Item Number	Sec #	Description	Quantity	Unit Cost	Amount
0070	7980000000-N	SP	GENERIC SIGNAL ITEM FURNISH FLASHER MODULE	10 EA		
0071	7980000000-N	SP	GENERIC SIGNAL ITEM FURNISH LOAD SWITCH	10 EA		
0072	7980000000-N	SP	GENERIC SIGNAL ITEM FURNISH POLE MOUNT 336 CABINET	2 EA		
0073	7980000000-N	SP	GENERIC SIGNAL ITEM FURNISH ST PIGTAILS	20 EA		
0074	7980000000-N	SP	GENERIC SIGNAL ITEM FURNISH ST-LC HYBRID JUMPERS	40 EA		
0075	7980000000-N	SP	GENERIC SIGNAL ITEM FURNISH SURGE PROTECTOR	10 EA		
0076	7980000000-N	SP	GENERIC SIGNAL ITEM FURNISH TEST CABINET AND CON- TROLLER	1 EA		
0077	7980000000-N	SP	GENERIC SIGNAL ITEM INTERCONNECT CENTER (OVERSIZED)	5 EA		
0078	7980000000-N	SP	GENERIC SIGNAL ITEM INTERCONNECT CENTER (STANDARD)	308 EA		
0079	7980000000-N	SP	GENERIC SIGNAL ITEM KVM SWITCH	1 EA		
0080	7980000000-N	SP	GENERIC SIGNAL ITEM LCD VIDEO MONITOR	1 EA		
0081	7980000000-N	SP	GENERIC SIGNAL ITEM NETWORK ETHERNET SWITCH	1 EA		
0082	7980000000-N	SP	GENERIC SIGNAL ITEM RACK CABINET	1 EA		
0083	7980000000-N	SP	GENERIC SIGNAL ITEM REMOTE ACCESS SERVER	1 EA		
0084	7980000000-N	SP	GENERIC SIGNAL ITEM REMOVE AND REPLACE EXISTING WOOD SIGNAL POLE	5 EA		



County : Cumberland

Line #	Item Number	Sec #	Description	Quantity	Unit Cost	Amount
0085	7980000000-N	SP	GENERIC SIGNAL ITEM REMOVE EXISTING CCTV ASSEMBLY	25 EA		
0086	7980000000-N	SP	GENERIC SIGNAL ITEM REMOVE EXISTING CCTV CABINET	1 EA		
0087	7980000000-N	SP	GENERIC SIGNAL ITEM REMOVE EXISTING CCTV CABINET AND FOUNDATION	10 EA		
0088	7980000000-N	SP	GENERIC SIGNAL ITEM REMOVE EXISTING WIRELESS RADIO AND ANTENNA	43 EA		
0089	7980000000-N	SP	GENERIC SIGNAL ITEM SIGNAL SYSTEM COMMUNICATIONS SERVER	1 EA		
0090	7980000000-N	SP	GENERIC SIGNAL ITEM SPLICE CABINET	1 EA		
0091	7980000000-N	SP	GENERIC SIGNAL ITEM VEHICLE SIGNAL HEAD (12", 3 SECTION WITH BI-MODAL SECTION)	8 EA		
0092	7980000000-N	SP	GENERIC SIGNAL ITEM WIRELESS ETHERNET RADIO SYSTEM	12 EA		
0093	7985000000-N	SP	GENERIC SIGNAL ITEM COMPUTER HARDWARE INTEGRATION	Lump Sum	L.S.	
0094	7985000000-N	SP	GENERIC SIGNAL ITEM LAN INTEGRATION	Lump Sum	L.S.	
0095	7985000000-N	SP	GENERIC SIGNAL ITEM NETWORK PERFORMANCE MANAGEMENT SOFTWARE	Lump Sum	L.S.	
0096	7985000000-N	SP	GENERIC SIGNAL ITEM TRAINING	Lump Sum	L.S.	
0097	7985000000-N	SP	GENERIC SIGNAL ITEM UPGRADE CCTV SYSTEM SOFTWARE	Lump Sum	L.S.	
0098	7985000000-N	SP	GENERIC SIGNAL ITEM UPGRADE SIGNAL SYSTEM SOFTWARE	Lump Sum	L.S.	
0099	7985000000-N	SP	GENERIC SIGNAL ITEM VIDEO WALL SYSTEM	Lump Sum	L.S.	

County : Cumberland

Line #	Item Number	Sec #	Description	Quantity	Unit Cost	Amount
0100	7990000000-E	SP	GENERIC SIGNAL ITEM BACK PULL FIBER OPTIC CABLE	600 LF		
-----						
0101	7990000000-E	SP	GENERIC SIGNAL ITEM ETHERNET CABLE	5,800 LF		
-----						
<b>1100/Jan06/Q276844.0/D740734592200/E101</b>			<b>Total Amount Of Bid For Entire Project :</b>			

NO GOALS SET FOR THIS PROJECT

Vendor 1 of 4: FULCHER ELECTRIC OF FAYETTEVILLE INC  
(3591)  
Call Order 002 (Proposal: C203954)

### Bid Information

---

<b>Proposal County:</b> CUMBERLAND	<b>Bid Checksum:</b> 34B2BD6F
<b>Vendor Address:</b> PO Box 2799 Fayetteville , NC , 28302	<b>Bid Total:</b> \$6,428,191.76
<b>Signature Check:</b> Louis_Fulcher__Jr._3591	<b>Items Total:</b> \$6,428,191.76
<b>Time Bid Received:</b> February 21, 2017 11:22 AM	<b>Time Total:</b> \$0.00
<b>Amendment Count:</b> 0	

**Bidding Errors:**  
None.

Vendor 1 of 4: FULCHER ELECTRIC OF FAYETTEVILLE INC  
(3591)  
Call Order 002 (Proposal: C203954)

### Bid Bond Information

---

<b>Projects:</b>	<b>Bond Maximum:</b>
<b>Counties:</b>	<b>State of Incorporation:</b>
<b>Bond ID:</b> SNC17404112	<b>Agency Execution Date:</b> 2/16/2017 9
<b>Paid by Check:</b> No	<b>Surety Name:</b> surety2000
<b>Bond Percent:</b> 5%	<b>Bond Agency Name:</b> Selective Insurance Company of America

Bidder 1 of 4

Vendor 3591's Bid Information for Call 002, Letting L170221, 02/21/17

Fulcher Electric of Fayetteville, Inc. (3591)  
Call Order 002 (Proposal ID C203954)

Miscellaneous Data Info - Contractor Responses:  
=====

NON-COLLUSION AND DEBARMENT CERTIFICATION

Explanation of the prospective bidder that is unable to certify to any of the statements in this certification:

Explanation:  
N/A  
NOT ANSWERED  
NOT ANSWERED  
NOT ANSWERED

AWARD LIMITS ON MULTIPLE PROJECTS

By answering YES to this statement, the bidder acknowledges that they are using the award limits on multiple projects. No

It is the desire of the Bidder to be awarded contracts, the value of which will not exceed a total of NOT ANSWERED for those projects indicated herein, for which bids will be opened on (MM/DD/YY)

The Award Limits shall apply to the following projects:

Contract Number	County
NOT ANSWERED	
NOT ANSWERED	
NOT ANSWERED	
NOT ANSWERED	
NOT ANSWERED	
NOT ANSWERED	

Bid Bond Data Info - Contractor Responses:  
=====

BondID: SNC17404112  
Surety Registry Agency: surety2000  
Verified?: Yes  
Surety Agency: Selective Insurance Company of America  
Bond Execution Date: 2/16/2017 9  
Bond Amount: \$321,409.59 (Five Percent of Bid)

Dept of Transportation

Revised:

Contract ID: C203954

Project(s): STATE FUNDED

Letting Date: 02-21-17 Call Order: 002

Bidder: 3591 - Fulcher Electric of Fayetteville, Inc.

Line No.	Item Description	Approx. Quantity and Units	Unit Price Dollars   Cts	Bid Amount Dollars   Ct
Section 0001 ROADWAY ITEMS				
Alt Group				
0001	0000100000-N MOBILIZATION	LUMP	LUMP	303,774.00
0002	4405000000-E WORK ZONE SIGNS (PORTABLE)	325.000 SF	3.50000	1,137.50
0003	4410000000-E WORK ZONE SIGNS (BARRICADE MOUNTED)	150.000 SF	3.50000	525.00
0004	4415000000-N FLASHING ARROW BOARD	2.000 EA	500.00000	1,000.00
0005	4420000000-N PORTABLE CHANGEABLE MESSAGE SIGN	2.000 EA	5,000.00000	10,000.00
0006	4430000000-N DRUMS	60.000 EA	5.00000	300.00
0007	4435000000-N CONES	40.000 EA	10.00000	400.00
0008	4445000000-E BARRICADES (TYPE III)	80.000 LF	4.00000	320.00
0009	4450000000-N FLAGGER	2,400.000 HR	16.00000	38,400.00
0010	4480000000-N TMA	2.000 EA	2,500.00000	5,000.00
0011	4510000000-N LAW ENFORCEMENT	1,200.000 HR	34.00000	40,800.00

Dept of Transportation

Revised:

Contract ID: C203954

Project(s): STATE FUNDED

Letting Date: 02-21-17 Call Order: 002

Bidder: 3591 - Fulcher Electric of Fayetteville, Inc.

Line No.	Item Description	Approx. Quantity and Units	Unit Price Dollars   Cts	Bid Amount Dollars   Ct
0012	4516000000-N SKINNY DRUM	40.000	10.00000	400.00
		EA		
0013	7060000000-E SIGNAL CABLE	5,800.000	3.84000	22,272.00
		LF		
0014	7120000000-E VEHICLE SIGNAL HEAD (12", 3 SECTION)	17.000	745.00000	12,665.00
		EA		
0015	7132000000-E VEHICLE SIGNAL HEAD (12", 4 SECTION)	10.000	850.00000	8,500.00
		EA		
0016	7252000000-E MESSENGER CABLE (1/4")	38,200.000	1.48000	56,536.00
		LF		
0017	7279000000-E TRACER WIRE	41,300.000	0.54000	22,302.00
		LF		
0018	7300000000-E UNPAVED TRENCHING (***** (1, 2"))	2,100.000	6.50000	13,650.00
		LF		
0019	7300000000-E UNPAVED TRENCHING (***** (2, 2"))	28,500.000	5.48000	156,180.00
		LF		
0020	7301000000-E DIRECTIONAL DRILL (***** (1- 5" CONDUIT ENCASING 2 - 2" CONDUITS)	300.000	40.00000	12,000.00
		LF		
0021	7301000000-E DIRECTIONAL DRILL (***** (1, 2"))	400.000	12.00000	4,800.00
		LF		
0022	7301000000-E DIRECTIONAL DRILL (***** (2, 2"))	10,300.000	12.88000	132,664.00
		LF		

## Dept of Transportation

Revised:

Contract ID: C203954

Project(s): STATE FUNDED

Letting Date: 02-21-17 Call Order: 002

Bidder: 3591 - Fulcher Electric of Fayetteville, Inc.

Line No.	Item Description	Approx. Quantity and Units	Unit Price Dollars   Cts	Bid Amount Dollars   Ct
0023	7324000000-N JUNCTION BOX (STANDARD SIZE)	53.000 EA	234.00000	12,402.00
0024	7348000000-N JUNCTION BOX (OVER-SIZED, HEA-VY DUTY)	133.000 EA	414.00000	55,062.00
0025	7360000000-N WOOD POLE	2.000 EA	900.00000	1,800.00
0026	7372000000-N GUY ASSEMBLY	100.000 EA	225.00000	22,500.00
0027	7420000000-E 2" RISER WITH WEATHERHEAD	26.000 EA	355.00000	9,230.00
0028	7430000000-N HEAT SHRINK TUBING RETROFIT KIT	8.000 EA	145.00000	1,160.00
0029	7432000000-E 2" RISER WITH HEAT SHRINK TUBING	48.000 EA	450.00000	21,600.00
0030	7444000000-E INDUCTIVE LOOP SAWCUT	1,250.000 LF	5.24000	6,550.00
0031	7456000000-E LEAD-IN CABLE (*****)(14-2)	13,500.000 LF	1.48000	19,980.00
0032	7516000000-E COMMUNICATIONS CABLE (**FIBER) (24)	103,500.000 LF	1.74000	180,090.00
0033	7516000000-E COMMUNICATIONS CABLE (**FIBER) (48)	800.000 LF	2.24000	1,792.00
0034	7528000000-E DROP CABLE	13,700.000 LF	1.74000	23,838.00



Contract ID: C203954 Project(s): STATE FUNDED

Letting Date: 02-21-17 Call Order: 002

Bidder: 3591 - Fulcher Electric of Fayetteville, Inc.

Line No.	Item Description	Approx. Quantity and Units	Unit Price Dollars   Cts	Bid Amount Dollars   Ct
0035	7540000000-N SPLICE ENCLOSURE	35.000 EA	1,524.70000	53,364.50
0036	7541000000-N MODIFY SPLICE ENCLOSURE	50.000 EA	1,404.12000	70,206.00
0037	7566000000-N DELINEATOR MARKER	82.000 EA	102.50000	8,405.00
0038	7575142200-N NEW ELECTRICAL SERVICE	3.000 EA	1,200.00000	3,600.00
0039	7575160000-E REMOVE EXISTING COMMUNICATIONSCABLE	2,100.000 LF	1.00000	2,100.00
0040	7575180000-N CABLE TRANSFER	10.000 EA	264.00000	2,640.00
0041	7684000000-N SIGNAL CABINET FOUNDATION	2.000 EA	1,200.00000	2,400.00
0042	7686000000-N CONDUIT ENTRANCE INTO EXISTINGFOUNDATION	55.000 EA	210.00000	11,550.00
0043	7687000000-N MODIFY FOUNDATION FOR CONTROL-LER CABINET	4.000 EA	485.00000	1,940.00
0044	7696000000-N CONTROLLER WITH CABINET (***** ) (2070E, 332 BASE MOUNTED)	98.000 EA	8,551.55000	838,051.90
0045	7696000000-N CONTROLLER WITH CABINET (***** ) (2070E, 336S POLE MOUNTED)	8.000 EA	8,117.51000	64,940.08

Dept of Transportation

Revised:

Contract ID: C203954

Project(s): STATE FUNDED

Letting Date: 02-21-17 Call Order: 002

Bidder: 3591 - Fulcher Electric of Fayetteville, Inc.

Line No.	Item Description	Approx. Quantity and Units	Unit Price Dollars   Cts	Bid Amount Dollars   Ct
0046	7708000000-N DETECTOR CARD (***** (2070L)	2,137.000 EA	67.61000	144,482.57
0047	7901000000-N CABINET BASE EXTENDER	295.000 EA	222.39000	65,605.05
0048	7901010000-N CABINET BASE ADAPTER	2.000 EA	550.00000	1,100.00
0049	7980000000-N GENERIC SIGNAL ITEM BACKUP STORAGE SERVER	1.000 EA	14,237.67000	14,237.67
0050	7980000000-N GENERIC SIGNAL ITEM CCTV VIDEO SERVER	1.000 EA	8,392.01000	8,392.01
0051	7980000000-N GENERIC SIGNAL ITEM CCTV WOOD POLE	13.000 EA	2,355.00000	30,615.00
0052	7980000000-N GENERIC SIGNAL ITEM COMPUTER WORKSTATION	6.000 EA	1,856.02000	11,136.12
0053	7980000000-N GENERIC SIGNAL ITEM CONTROLLER WITH CABINET AND AUX FILE (2070E, 332 BASE MOUNTED)	199.000 EA	9,025.18000	1,796,010.82
0054	7980000000-N GENERIC SIGNAL ITEM CONTROLLER WITH CABINET AND AUX FILE (2070E, 336S POLE MOUNTED)	1.000 EA	8,953.00000	8,953.00
0055	7980000000-N GENERIC SIGNAL ITEM CORE ETHERNET SWITCH	1.000 EA	67,000.00000	67,000.00
0056	7980000000-N GENERIC SIGNAL ITEM DIGITAL CCTV CAMERA ASSEMBLY	50.000 EA	4,016.40000	200,820.00

Dept of Transportation

Revised:

Contract ID: C203954

Project(s): STATE FUNDED

Letting Date: 02-21-17 Call Order: 002

Bidder: 3591 - Fulcher Electric of Fayetteville, Inc.

Line No.	Item Description	Approx. Quantity and Units	Unit Price Dollars   Cts	Bid Amount Dollars   Ct
0057	7980000000-N GENERIC SIGNAL ITEM DISTRIBUTED PROCESSING SIGNAL SYSTEM SERVER	1.000 EA	13,790.15000	13,790.15
0058	7980000000-N GENERIC SIGNAL ITEM FIELD EQUIPMENT CABINET	3.000 EA	4,068.00000	12,204.00
0059	7980000000-N GENERIC SIGNAL ITEM FIELD ETHERNET SWITCH	311.000 EA	1,123.50000	349,408.50
0060	7980000000-N GENERIC SIGNAL ITEM FURNISH 2070-1E CPU MODULE	10.000 EA	397.42000	3,974.20
0061	7980000000-N GENERIC SIGNAL ITEM FURNISH 2070L CONTROLLER	10.000 EA	1,410.58000	14,105.80
0062	7980000000-N GENERIC SIGNAL ITEM FURNISH AC ISOLATOR CARD	10.000 EA	41.60000	416.00
0063	7980000000-N GENERIC SIGNAL ITEM FURNISH BASE MOUNT 332 CABINET	8.000 EA	7,451.00000	59,608.00
0064	7980000000-N GENERIC SIGNAL ITEM FURNISH CCTV ASSEMBLY	5.000 EA	2,824.80000	14,124.00
0065	7980000000-N GENERIC SIGNAL ITEM FURNISH CONFLICT MONITOR	10.000 EA	835.37000	8,353.70
0066	7980000000-N GENERIC SIGNAL ITEM FURNISH DC ISOLATOR CARD	10.000 EA	32.84000	328.40
0067	7980000000-N GENERIC SIGNAL ITEM FURNISH DETECTOR CARD	20.000 EA	78.86000	1,577.20

Dept of Transportation

Revised:

Contract ID: C203954

Project(s): STATE FUNDED

Letting Date: 02-21-17 Call Order: 002

Bidder: 3591 - Fulcher Electric of Fayetteville, Inc.

Line No.	Item Description	Approx. Quantity and Units	Unit Price Dollars   Cts	Bid Amount Dollars   Ct
0068	7980000000-N GENERIC SIGNAL ITEM FURNISH FIELD ETHERNET SWITCH	10.000 EA	1,074.96000	10,749.60
0069	7980000000-N GENERIC SIGNAL ITEM FURNISH FLASH TRANSFER RELAY	10.000 EA	27.60000	276.00
0070	7980000000-N GENERIC SIGNAL ITEM FURNISH FLASHER MODULE	10.000 EA	26.28000	262.80
0071	7980000000-N GENERIC SIGNAL ITEM FURNISH LOAD SWITCH	10.000 EA	24.34000	243.40
0072	7980000000-N GENERIC SIGNAL ITEM FURNISH POLE MOUNT 336 CABINET	2.000 EA	8,400.00000	16,800.00
0073	7980000000-N GENERIC SIGNAL ITEM FURNISH ST PIGTAILS	20.000 EA	29.50000	590.00
0074	7980000000-N GENERIC SIGNAL ITEM FURNISH ST-LC HYBRID JUMPERS	40.000 EA	19.25000	770.00
0075	7980000000-N GENERIC SIGNAL ITEM FURNISH SURGE PROTECTOR	10.000 EA	63.96000	639.60
0076	7980000000-N GENERIC SIGNAL ITEM FURNISH TEST CABINET AND CON- TROLLER	1.000 EA	12,761.44000	12,761.44
0077	7980000000-N GENERIC SIGNAL ITEM INTERCONNECT CENTER (OVERSIZED)	5.000 EA	10,238.25000	51,191.25
0078	7980000000-N GENERIC SIGNAL ITEM INTERCONNECT CENTER (STANDARD)	308.000 EA	1,302.15000	401,062.20
0079	7980000000-N GENERIC SIGNAL ITEM KVM SWITCH	1.000 EA	3,319.17000	3,319.17

Dept of Transportation

Revised:

Contract ID: C203954

Project(s): STATE FUNDED

Letting Date: 02-21-17 Call Order: 002

Bidder: 3591 - Fulcher Electric of Fayetteville, Inc.

Line No.	Item Description	Approx. Quantity and Units	Unit Price Dollars   Cts	Bid Amount Dollars   Ct
0080	7980000000-N GENERIC SIGNAL ITEM LCD VIDEO MONITOR	1.000 EA	3,001.42000	3,001.42
0081	7980000000-N GENERIC SIGNAL ITEM NETWORK ETHERNET SWITCH	1.000 EA	8,488.70000	8,488.70
0082	7980000000-N GENERIC SIGNAL ITEM RACK CABINET	1.000 EA	25,371.84000	25,371.84
0083	7980000000-N GENERIC SIGNAL ITEM REMOTE ACCESS SERVER	1.000 EA	8,703.89000	8,703.89
0084	7980000000-N GENERIC SIGNAL ITEM REMOVE AND REPLACE EXISTING WOOD SIGNAL POLE	5.000 EA	3,500.00000	17,500.00
0085	7980000000-N GENERIC SIGNAL ITEM REMOVE EXISTING CCTV ASSEMBLY	25.000 EA	525.00000	13,125.00
0086	7980000000-N GENERIC SIGNAL ITEM REMOVE EXISTING CCTV CABINET	1.000 EA	1,250.00000	1,250.00
0087	7980000000-N GENERIC SIGNAL ITEM REMOVE EXISTING CCTV CABINET AND FOUNDATION	10.000 EA	1,500.00000	15,000.00
0088	7980000000-N GENERIC SIGNAL ITEM REMOVE EXISTING WIRELESS RADIO AND ANTENNA	43.000 EA	225.00000	9,675.00
0089	7980000000-N GENERIC SIGNAL ITEM SIGNAL SYSTEM COMMUNICATIONS SERVER	1.000 EA	7,962.98000	7,962.98
0090	7980000000-N GENERIC SIGNAL ITEM SPLICE CABINET	1.000 EA	3,806.00000	3,806.00

Dept of Transportation

Revised:

Contract ID: C203954

Project(s): STATE FUNDED

Letting Date: 02-21-17 Call Order: 002

Bidder: 3591 - Fulcher Electric of Fayetteville, Inc.

Line No.	Item Description	Approx. Quantity and Units	Unit Price Dollars   Cts	Bid Amount Dollars   Ct
0091	7980000000-N GENERIC SIGNAL ITEM VEHICLE SIGNAL HEAD (12", 3 SECTION WITH BI-MODAL SECTION)	8.000 EA	915.00000	7,320.00
0092	7980000000-N GENERIC SIGNAL ITEM WIRELESS ETHERNET RADIO SYSTEM	12.000 EA	4,256.50000	51,078.00
0093	7985000000-N GENERIC SIGNAL ITEM COMPUTER HARDWARE INTEGRATION	LUMP	LUMP	14,033.71
0094	7985000000-N GENERIC SIGNAL ITEM LAN INTEGRATION	LUMP	LUMP	33,600.00
0095	7985000000-N GENERIC SIGNAL ITEM NETWORK PERFORMANCE MANAGEMENT SOFTWARE	LUMP	LUMP	74,998.44
0096	7985000000-N GENERIC SIGNAL ITEM TRAINING	LUMP	LUMP	43,275.60
0097	7985000000-N GENERIC SIGNAL ITEM UPGRADE CCTV SYSTEM SOFTWARE	LUMP	LUMP	5,892.55
0098	7985000000-N GENERIC SIGNAL ITEM UPGRADE SIGNAL SYSTEM SOFTWARE	LUMP	LUMP	382,694.00
0099	7985000000-N GENERIC SIGNAL ITEM VIDEO WALL SYSTEM	LUMP	LUMP	104,280.00
0100	7990000000-E GENERIC SIGNAL ITEM BACK PULL FIBER OPTIC CABLE	600.000 LF	3.00000	1,800.00
0101	7990000000-E GENERIC SIGNAL ITEM ETHERNET CABLE	5,800.000 LF	2.00000	11,600.00

Contract ID: C203954

Project(s): STATE FUNDED

Letting Date: 02-21-17 Call Order: 002

Bidder: 3591 - Fulcher Electric of Fayetteville, Inc.

Line No.	Item Description	Approx. Quantity and Units	Unit Price Dollars   Cts	Bid Amount Dollars   Ct
	Section 0001 Total			6,428,191.76
	Bid Total			6,428,191.76

NON-COLLUSION AND DEBARMENT CERTIFICATION

The bidder certifies that neither he, nor any official, agent or employee of the bidder has entered into any agreement, participated in any collusion, or otherwise taken any action which is in restraint of free competitive bidding in connection with this bid, and that the bidder intends to do the work with its own bonafide employees or subcontractors and is not bidding for the benefit of another contractor. In addition, submitting this electronic bid constitutes the bidder's certification of Status under penalty of perjury under the laws of the United States and in accordance with the Debarment Certification on file with the Department.

By submitting this bid, the bidder certifies to the best of his knowledge and belief that he and his principals:

- a. Are not presently debarred, suspended, proposed for debarment, declared ineligible, or voluntarily excluded from covered transactions by any Federal department or agency;
- b. Have not within a three-year period preceding this proposal been convicted of or had a civil judgment rendered against them for commission of fraud or a criminal offense in connection with obtaining, attempting to obtain, or performing a public (Federal, State or local) transaction or contract under a public transaction; violation of Federal or State antitrust statutes or commission of embezzlement, theft, forgery, bribery, falsification or destruction of records; making false statements; or receiving stolen property;
- c. Are not presently indicted for or otherwise criminally or civilly charged by a governmental entity (Federal, State or local) with commission of any of the offenses enumerated in paragraph b. of this certification; and
- d. Have not within a three-year period preceding this proposal had one or more public transactions (Federal, State or local) terminated for cause or default.

Where the prospective bidder is unable to certify to any of the statements in this certification, the bidder shall submit an explanation in the blanks provided herein. The explanation will not necessarily result in denial of participation in a contract.

Explanation:

N/A  
NOT ANSWERED  
NOT ANSWERED  
NOT ANSWERED

If the prequalified bidder's status changes, he shall immediately submit a new fully executed non-collusion affidavit and debarment certification with an explanation of the change to the Contract Office prior to submitting the bid.

Failure to furnish a certification or an explanation will be grounds for rejection of a bid



AWARD LIMITS ON MULTIPLE PROJECTS

By answering YES to this statement, the bidder acknowledges that they are using the award limits on multiple projects. No

A bidder who desires to bid on more than one project on which bids are to be opened on the same date, and who also desires to avoid receiving an award of more projects than he is equipped to handle, may bid on any number of projects but may limit the total amount of work awarded to him on selected projects by completing the AWARD LIMITS ON MULTIPLE PROJECTS.

The Award Limits on Multiple Projects must be filled in on each project bid for which the Bidder desires protection.

It is the desire of the Bidder to be awarded contracts, the value of which will not exceed a total of NOT ANSWERED for those projects indicated herein, for which bids will be opened on (MM/DD/YY)

The Award Limits shall apply to the following projects:

Contract Number	County
NOT ANSWERED	
NOT ANSWERED	
NOT ANSWERED	
NOT ANSWERED	
NOT ANSWERED	
NOT ANSWERED	

It is agreed that if I am (we are) the low Bidder(s) on indicated projects, the total value of which is more than the above stipulated award limits, the Board of Transportation will award me (us) projects from among those indicated that have a total value not to exceed the award limit and will result in the lowest total bids to the Department of Transportation.

THIS PROPOSAL CONTAINS THE FOLLOWING ERRORS/WARNINGS (IF ANY)

This Bid contains 0 amendment files

Electronic Bid Submission

By submitting this bid electronically, I hereby acknowledge that all requirements included in the hard copy proposal, addendum, amendments, plans, standard specifications, supplemental specifications and special provisions are part of the bid and contract. Further, I acknowledge that I have read, understand, accept, acknowledge and agree to comply with all statements in this electronic bid.

I Hereby certify that I have the authority to submit this bid.

Signature

Agency

Date

-----  
-----  
-----

## Contract Item Sheets For C203954

Line #	ItemNumber	Sec #	Description	Quantity Unit	Unit Bid Price	Amount Bid
<b>ROADWAY ITEMS</b>						
0001	0000100000-N	800	MOBILIZATION	Lump Sum LS	303,774.00	303,774.00
0002	4405000000-E	1110	WORK ZONE SIGNS (PORTABLE)	325 SF	3.50	1,137.50
0003	4410000000-E	1110	WORK ZONE SIGNS (BARRICADE MOUNTED)	150 SF	3.50	525.00
0004	4415000000-N	1115	FLASHING ARROW BOARD	2 EA	500.00	1,000.00
0005	4420000000-N	1120	PORTABLE CHANGEABLE MESSAGE SIGN	2 EA	5,000.00	10,000.00
0006	4430000000-N	1130	DRUMS	60 EA	5.00	300.00
0007	4435000000-N	1135	CONES	40 EA	10.00	400.00
0008	4445000000-E	1145	BARRICADES (TYPE III)	80 LF	4.00	320.00
0009	4450000000-N	1150	FLAGGER	2,400 HR	16.00	38,400.00
0010	4480000000-N	1165	TMA	2 EA	2,500.00	5,000.00
0011	4510000000-N	SP	LAW ENFORCEMENT	1,200 HR	34.00	40,800.00
0012	4516000000-N	1180	SKINNY DRUM	40 EA	10.00	400.00
0013	7060000000-E	1705	SIGNAL CABLE	5,800 LF	3.84	22,272.00
0014	7120000000-E	1705	VEHICLE SIGNAL HEAD (12", 3 SECTION)	17 EA	745.00	12,665.00
0015	7132000000-E	1705	VEHICLE SIGNAL HEAD (12", 4 SECTION)	10 EA	850.00	8,500.00
0016	7252000000-E	1710	MESSENGER CABLE (1/4")	38,200 LF	1.48	56,536.00
0017	7279000000-E	1715	TRACER WIRE	41,300 LF	0.54	22,302.00
0018	7300000000-E	1715	UNPAVED TRENCHING (*****) (1, 2")	2,100 LF	6.50	13,650.00
0019	7300000000-E	1715	UNPAVED TRENCHING (*****) (2, 2")	28,500 LF	5.48	156,180.00

Line #	ItemNumber	Sec #	Description	Quantity Unit	Unit Bid Price	Amount Bid
0020	7301000000-E	1715	DIRECTIONAL DRILL (*****) (1- 5" CONDUIT ENCASING 2 - 2" CONDUITS)	300 LF	40.00	12,000.00
0021	7301000000-E	1715	DIRECTIONAL DRILL (*****) (1, 2")	400 LF	12.00	4,800.00
0022	7301000000-E	1715	DIRECTIONAL DRILL (*****) (2, 2")	10,300 LF	12.88	132,664.00
0023	7324000000-N	1716	JUNCTION BOX (STANDARD SIZE)	53 EA	234.00	12,402.00
0024	7348000000-N	1716	JUNCTION BOX (OVER-SIZED, HEA- VY DUTY)	133 EA	414.00	55,062.00
0025	7360000000-N	1720	WOOD POLE	2 EA	900.00	1,800.00
0026	7372000000-N	1721	GUY ASSEMBLY	100 EA	225.00	22,500.00
0027	7420000000-E	1722	2" RISER WITH WEATHERHEAD	26 EA	355.00	9,230.00
0028	7430000000-N	1722	HEAT SHRINK TUBING RETROFIT KIT	8 EA	145.00	1,160.00
0029	7432000000-E	1722	2" RISER WITH HEAT SHRINK TUBING	48 EA	450.00	21,600.00
0030	7444000000-E	1725	INDUCTIVE LOOP SAWCUT	1,250 LF	5.24	6,550.00
0031	7456000000-E	1726	LEAD-IN CABLE (***** (14-2)	13,500 LF	1.48	19,980.00
0032	7516000000-E	1730	COMMUNICATIONS CABLE (**FIBER) (24)	103,500 LF	1.74	180,090.00
0033	7516000000-E	1730	COMMUNICATIONS CABLE (**FIBER) (48)	800 LF	2.24	1,792.00
0034	7528000000-E	1730	DROP CABLE	13,700 LF	1.74	23,838.00
0035	7540000000-N	1731	SPLICE ENCLOSURE	35 EA	1,524.70	53,364.50
0036	7541000000-N	1731	MODIFY SPLICE ENCLOSURE	50 EA	1,404.12	70,206.00
0037	7566000000-N	1733	DELINEATOR MARKER	82 EA	102.50	8,405.00

Line #	ItemNumber	Sec #	Description	Quantity Unit	Unit Bid Price	Amount Bid
0038	7575142200-N	SP	NEW ELECTRICAL SERVICE	3 EA	1,200.00	3,600.00
0039	7575160000-E	1734	REMOVE EXISTING COMMUNICATIONS CABLE	2,100 LF	1.00	2,100.00
0040	7575180000-N	1735	CABLE TRANSFER	10 EA	264.00	2,640.00
0041	7684000000-N	1750	SIGNAL CABINET FOUNDATION	2 EA	1,200.00	2,400.00
0042	7686000000-N	1752	CONDUIT ENTRANCE INTO EXISTING FOUNDATION	55 EA	210.00	11,550.00
0043	7687000000-N	1752	MODIFY FOUNDATION FOR CONTROLLER CABINET	4 EA	485.00	1,940.00
0044	7696000000-N	1751	CONTROLLER WITH CABINET (*****) (2070E, 332 BASE MOUNTED)	98 EA	8,551.55	838,051.90
0045	7696000000-N	1751	CONTROLLER WITH CABINET (*****) (2070E, 336S POLE MOUNTED)	8 EA	8,117.51	64,940.08
0046	7708000000-N	1751	DETECTOR CARD (*****) (2070L)	2,137 EA	67.61	144,482.57
0047	7901000000-N	1753	CABINET BASE EXTENDER	295 EA	222.39	65,605.05
0048	7901010000-N	1753	CABINET BASE ADAPTER	2 EA	550.00	1,100.00
0049	7980000000-N	SP	GENERIC SIGNAL ITEM BACKUP STORAGE SERVER	1 EA	14,237.67	14,237.67
0050	7980000000-N	SP	GENERIC SIGNAL ITEM CCTV VIDEO SERVER	1 EA	8,392.01	8,392.01
0051	7980000000-N	SP	GENERIC SIGNAL ITEM CCTV WOOD POLE	13 EA	2,355.00	30,615.00
0052	7980000000-N	SP	GENERIC SIGNAL ITEM COMPUTER WORKSTATION	6 EA	1,856.02	11,136.12
0053	7980000000-N	SP	GENERIC SIGNAL ITEM CONTROLLER WITH CABINET AND AUX FILE (2070E, 332 BASE MOUNTED)	199 EA	9,025.18	1,796,010.82

## Contract Item Sheets For C203954

Line #	ItemNumber	Sec #	Description	Quantity Unit	Unit Bid Price	Amount Bid
0054	7980000000-N	SP	GENERIC SIGNAL ITEM CONTROLLER WITH CABINET AND AUX FILE (2070E, 336S POLE MOUNTED)	1 EA	8,953.00	8,953.00
0055	7980000000-N	SP	GENERIC SIGNAL ITEM CORE ETHERNET SWITCH	1 EA	67,000.00	67,000.00
0056	7980000000-N	SP	GENERIC SIGNAL ITEM DIGITAL CCTV CAMERA ASSEMBLY	50 EA	4,016.40	200,820.00
0057	7980000000-N	SP	GENERIC SIGNAL ITEM DISTRIBUTED PROCESSING SIGNAL SYSTEM SERVER	1 EA	13,790.15	13,790.15
0058	7980000000-N	SP	GENERIC SIGNAL ITEM FIELD EQUIPMENT CABINET	3 EA	4,068.00	12,204.00
0059	7980000000-N	SP	GENERIC SIGNAL ITEM FIELD ETHERNET SWITCH	311 EA	1,123.50	349,408.50
0060	7980000000-N	SP	GENERIC SIGNAL ITEM FURNISH 2070-1E CPU MODULE	10 EA	397.42	3,974.20
0061	7980000000-N	SP	GENERIC SIGNAL ITEM FURNISH 2070L CONTROLLER	10 EA	1,410.58	14,105.80
0062	7980000000-N	SP	GENERIC SIGNAL ITEM FURNISH AC ISOLATOR CARD	10 EA	41.60	416.00
0063	7980000000-N	SP	GENERIC SIGNAL ITEM FURNISH BASE MOUNT 332 CABINET	8 EA	7,451.00	59,608.00
0064	7980000000-N	SP	GENERIC SIGNAL ITEM FURNISH CCTV ASSEMBLY	5 EA	2,824.80	14,124.00
0065	7980000000-N	SP	GENERIC SIGNAL ITEM FURNISH CONFLICT MONITOR	10 EA	835.37	8,353.70
0066	7980000000-N	SP	GENERIC SIGNAL ITEM FURNISH DC ISOLATOR CARD	10 EA	32.84	328.40
0067	7980000000-N	SP	GENERIC SIGNAL ITEM FURNISH DETECTOR CARD	20 EA	78.86	1,577.20
0068	7980000000-N	SP	GENERIC SIGNAL ITEM FURNISH FIELD ETHERNET SWITCH	10 EA	1,074.96	10,749.60
0069	7980000000-N	SP	GENERIC SIGNAL ITEM FURNISH FLASH TRANSFER RELAY	10 EA	27.60	276.00

## Contract Item Sheets For C203954

Line #	ItemNumber	Sec #	Description	Quantity Unit	Unit Bid Price	Amount Bid
0070	7980000000-N	SP	GENERIC SIGNAL ITEM FURNISH FLASHER MODULE	10 EA	26.28	262.80
0071	7980000000-N	SP	GENERIC SIGNAL ITEM FURNISH LOAD SWITCH	10 EA	24.34	243.40
0072	7980000000-N	SP	GENERIC SIGNAL ITEM FURNISH POLE MOUNT 336 CABINET	2 EA	8,400.00	16,800.00
0073	7980000000-N	SP	GENERIC SIGNAL ITEM FURNISH ST PIGTAILS	20 EA	29.50	590.00
0074	7980000000-N	SP	GENERIC SIGNAL ITEM FURNISH ST-LC HYBRID JUMPERS	40 EA	19.25	770.00
0075	7980000000-N	SP	GENERIC SIGNAL ITEM FURNISH SURGE PROTECTOR	10 EA	63.96	639.60
0076	7980000000-N	SP	GENERIC SIGNAL ITEM FURNISH TEST CABINET AND CON- TROLLER	1 EA	12,761.44	12,761.44
0077	7980000000-N	SP	GENERIC SIGNAL ITEM INTERCONNECT CENTER (OVERSIZED)	5 EA	10,238.25	51,191.25
0078	7980000000-N	SP	GENERIC SIGNAL ITEM INTERCONNECT CENTER (STANDARD)	308 EA	1,302.15	401,062.20
0079	7980000000-N	SP	GENERIC SIGNAL ITEM KVM SWITCH	1 EA	3,319.17	3,319.17
0080	7980000000-N	SP	GENERIC SIGNAL ITEM LCD VIDEO MONITOR	1 EA	3,001.42	3,001.42
0081	7980000000-N	SP	GENERIC SIGNAL ITEM NETWORK ETHERNET SWITCH	1 EA	8,488.70	8,488.70
0082	7980000000-N	SP	GENERIC SIGNAL ITEM RACK CABINET	1 EA	25,371.84	25,371.84
0083	7980000000-N	SP	GENERIC SIGNAL ITEM REMOTE ACCESS SERVER	1 EA	8,703.89	8,703.89
0084	7980000000-N	SP	GENERIC SIGNAL ITEM REMOVE AND REPLACE EXISTING WOOD SIGNAL POLE	5 EA	3,500.00	17,500.00

Line #	ItemNumber	Sec #	Description	Quantity Unit	Unit Bid Price	Amount Bid
0085	7980000000-N	SP	GENERIC SIGNAL ITEM REMOVE EXISTING CCTV ASSEMBLY	25 EA	525.00	13,125.00
0086	7980000000-N	SP	GENERIC SIGNAL ITEM REMOVE EXISTING CCTV CABINET	1 EA	1,250.00	1,250.00
0087	7980000000-N	SP	GENERIC SIGNAL ITEM REMOVE EXISTING CCTV CABINET AND FOUNDATION	10 EA	1,500.00	15,000.00
0088	7980000000-N	SP	GENERIC SIGNAL ITEM REMOVE EXISTING WIRELESS RADIO AND ANTENNA	43 EA	225.00	9,675.00
0089	7980000000-N	SP	GENERIC SIGNAL ITEM SIGNAL SYSTEM COMMUNICATIONS SERVER	1 EA	7,962.98	7,962.98
0090	7980000000-N	SP	GENERIC SIGNAL ITEM SPLICE CABINET	1 EA	3,806.00	3,806.00
0091	7980000000-N	SP	GENERIC SIGNAL ITEM VEHICLE SIGNAL HEAD (12", 3 SECTION WITH BI-MODAL SECTION)	8 EA	915.00	7,320.00
0092	7980000000-N	SP	GENERIC SIGNAL ITEM WIRELESS ETHERNET RADIO SYSTEM	12 EA	4,256.50	51,078.00
0093	7985000000-N	SP	GENERIC SIGNAL ITEM COMPUTER HARDWARE INTEGRATION	Lump Sum LS	14,033.71	14,033.71
0094	7985000000-N	SP	GENERIC SIGNAL ITEM LAN INTEGRATION	Lump Sum LS	33,600.00	33,600.00
0095	7985000000-N	SP	GENERIC SIGNAL ITEM NETWORK PERFORMANCE MANAGEMENT SOFTWARE	Lump Sum LS	74,998.44	74,998.44
0096	7985000000-N	SP	GENERIC SIGNAL ITEM TRAINING	Lump Sum LS	43,275.60	43,275.60
0097	7985000000-N	SP	GENERIC SIGNAL ITEM UPGRADE CCTV SYSTEM SOFTWARE	Lump Sum LS	5,892.55	5,892.55
0098	7985000000-N	SP	GENERIC SIGNAL ITEM UPGRADE SIGNAL SYSTEM SOFTWARE	Lump Sum LS	382,694.00	382,694.00
0099	7985000000-N	SP	GENERIC SIGNAL ITEM VIDEO WALL SYSTEM	Lump Sum LS	104,280.00	104,280.00



Contract Item Sheets For C203954

Line #	ItemNumber	Sec #	Description	Quantity Unit	Unit Bid Price	Amount Bid
0100	7990000000-E	SP	GENERIC SIGNAL ITEM BACK PULL FIBER OPTIC CABLE	600 LF	3.00	1,800.00
0101	7990000000-E	SP	GENERIC SIGNAL ITEM ETHERNET CABLE	5,800 LF	2.00	11,600.00
<b>TOTAL AMOUNT OF BID FOR ENTIRE PROJECT</b>						<b>\$6,428,191.76</b>

1444/Mar13/Q276844/D740734592200/E101

Contract No. C203954  
County Cumberland

Rev. 5-19-11

**EXECUTION OF CONTRACT  
NON-COLLUSION AFFIDAVIT, DEBARMENT CERTIFICATION AND GIFT BAN CERTIFICATION**

**CORPORATION**

The Contractor being duly sworn, solemnly swears (or affirms) that neither he, nor any official, agent or employee has entered into any agreement, participated in any collusion, or otherwise taken any action which is in restraint of free competitive bidding in connection with this Contract, that the Contractor has not been convicted of violating *N.C.G.S. § 133-24* within the last three years, and that the Contractor intends to do the work with its own bonafide employees or subcontractors and did not bid for the benefit of another contractor.

By submitting this Execution of Contract, Non-Collusion Affidavit and Debarment Certification, the Contractor is certifying his status under penalty of perjury under the laws of the United States in accordance with the Debarment Certification attached, provided that the Debarment Certification also includes any required statements concerning exceptions that are applicable.

*N.C.G.S. § 133-32* and Executive Order 24 prohibit the offer to, or acceptance by, any State Employee of any gift from anyone with a contract with the State, or from any person seeking to do business with the State. By execution of any response in this procurement, you attest, for your entire organization and its employees or agents, that you are not aware that any such gift has been offered, accepted, or promised by any employees of your organization.

**SIGNATURE OF CONTRACTOR**  
**Fulcher Electric of Fayetteville, Inc.**

Full name of Corporation

**P. O. Box 2799, Fayetteville, NC 28302**

Address as Prequalified

Attest *Louis A. Fulcher, IV*  
Secretary/Assistant Secretary  
Select appropriate title

By *Kenneth L. Fulcher*  
President/Vice President/Assistant Vice President  
Select appropriate title

**Louis A. Fulcher, IV**

Print or type Signer's name

**Kenneth L. Fulcher**

Print or type Signer's name

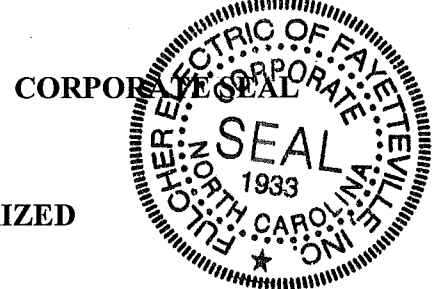

**AFFIDAVIT MUST BE NOTARIZED**

Subscribed and sworn to before me this the

16<sup>th</sup> day of March 2017.

*Kellie Thompson*  
Signature of Notary Public

of Cumberland County

State of North Carolina

My Commission Expires: Sept. 22, 2017

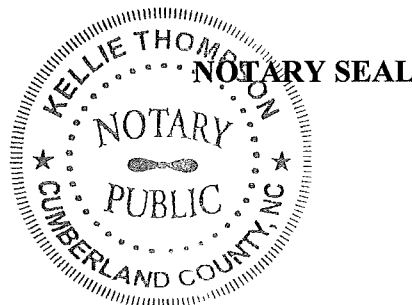

## DEBARMENT CERTIFICATION

### Conditions for certification:

1. The prequalified bidder shall provide immediate written notice to the Department if at any time the bidder learns that his certification was erroneous when he submitted his debarment certification or explanation filed with the Department, or has become erroneous because of changed circumstances.
2. The terms *covered transaction, debarred, suspended, ineligible, lower tier covered transaction, participant, person, primary covered transaction, principal, proposal, and voluntarily excluded*, as used in this provision, have the meanings set out in the Definitions and Coverage sections of the rules implementing Executive Order 12549. A copy of the Federal Rules requiring this certification and detailing the definitions and coverages may be obtained from the Contract Officer of the Department.
3. The prequalified bidder agrees by submitting this form, that he will not knowingly enter into any lower tier covered transaction with a person who is debarred, suspended, declared ineligible, or voluntarily excluded from participation in NCDOT contracts, unless authorized by the Department.
4. For Federal Aid projects, the prequalified bidder further agrees that by submitting this form he will include the Federal-Aid Provision titled *Required Contract Provisions Federal-Aid Construction Contract (Form FHWA PR 1273)* provided by the Department, without subsequent modification, in all lower tier covered transactions.
5. The prequalified bidder may rely upon a certification of a participant in a lower tier covered transaction that he is not debarred, suspended, ineligible, or voluntarily excluded from the covered transaction, unless he knows that the certification is erroneous. The bidder may decide the method and frequency by which he will determine the eligibility of his subcontractors.
6. Nothing contained in the foregoing shall be construed to require establishment of a system of records in order to render in good faith the certification required by this provision. The knowledge and information of a participant is not required to exceed that which is normally possessed by a prudent person in the ordinary course of business dealings.
7. Except as authorized in paragraph 6 herein, the Department may terminate any contract if the bidder knowingly enters into a lower tier covered transaction with a person who is suspended, debarred, ineligible, or voluntarily excluded from participation in this transaction, in addition to other remedies available by the Federal Government.

### DEBARMENT CERTIFICATION

The prequalified bidder certifies to the best of his knowledge and belief, that he and his principals:

- a. Are not presently debarred, suspended, proposed for debarment, declared ineligible, or voluntarily excluded from covered transactions by any Federal department or agency;
- b. Have not within a three-year period preceding this proposal been convicted of or had a civil judgment rendered against them for commission of fraud or a criminal offense in connection with obtaining, attempting to obtain, or performing a public (Federal, State or local) transaction or contract under a public transaction; violation of Federal or State antitrust statutes or commission of embezzlement, theft, forgery, bribery, falsification or destruction of records; making false statements; or receiving stolen property;
- c. Are not presently indicted for or otherwise criminally or civilly charged by a governmental entity (Federal, State or local) with commission of any of the offenses enumerated in paragraph b. of this certification; and
- d. Have not within a three-year period preceding this proposal had one or more public transactions (Federal, State or local) terminated for cause or default.
- e. Will submit a revised Debarment Certification immediately if his status changes and will show in his bid proposal an explanation for the change in status.

If the prequalified bidder cannot certify that he is not debarred, he shall provide an explanation with this submittal. An explanation will not necessarily result in denial of participation in a contract.

Failure to submit a non-collusion affidavit and debarment certification will result in the prequalified bidder's bid being considered non-responsive.

Check here if an explanation is attached to this certification.

**Contract No.**     **C203954**

**County (ies):**   **Cumberland**

ACCEPTED BY THE  
DEPARTMENT OF TRANSPORTATION

DocuSigned by:  
*Mike Holder*  
23D624B05BA54A9...  
\_\_\_\_\_  
Contract Officer

3/24/2017

\_\_\_\_\_  
Date

Execution of Contract and Bonds  
Approved as to Form:

DocuSigned by:  
*Colin Justice*  
1889E4C5ADF14AE...  
\_\_\_\_\_  
Attorney General

3/20/2017

\_\_\_\_\_  
Date

Signature Sheet (Bid - Acceptance by Department)

Contract No.  
County

C203954  
Cumberland

Rev 2-1-10

BondNo.B 1183071

### CONTRACT PAYMENT BOND

Date of Payment Bond Execution March 10th 2017

Name of Principal Contractor Fulcher Electric of Fayetteville, Inc.

Name of Surety: Selective Insurance Company of America

Name of Contracting Body: North Carolina Department of Transportation  
Raleigh, North Carolina

Amount of Bond: 6,428,192.00

Contract ID No.: C203954, Fayetteville, Cumberland Co

County Name: \_\_\_\_\_

KNOW ALL MEN BY THESE PRESENTS, That we, the PRINCIPAL CONTRACTOR (hereafter, PRINCIPAL) and SURETY above named, are held and firmly bound unto the above named Contracting Body, hereinafter called the Contracting Body, in the penal sum of the amount stated above for the payment of which sum well and truly to be made, we bind ourselves, our heirs, executors, administrators, and successors, jointly and severally, firmly by these presents.

THE CONDITION OF THIS OBLIGATION IS SUCH, that whereas the principal entered into a certain contract with the Contracting Body, numbered as shown above and hereto attached:

NOW THEREFORE, if the principal shall promptly make payment to all persons supplying labor and material in the prosecution of the work provided for in said contract, and any and all duly authorized modifications of said contract that may hereafter be made, notice of which modifications to the surety being hereby waived, then this obligation to be void; otherwise to remain in full force and virtue.

IN WITNESS WHEREOF, the above-bound parties have executed this instrument under their several seals on the date indicated above, the name and corporate seal of each corporate party being hereto affixed and these presents duly signed by its undersigned representative, pursuant to authority of its governing body.

Contract No.  
County

C203954  
Cumberland

Rev 2-1-10

**CONTRACT PAYMENT BOND**

*Affix Seal of Surety Company*

Selective Insurance Company of America  
Print or type Surety Company Name

By Robert Lamarr Johnson, Attorney-in-Fact  
Print, stamp or type name of Attorney-in-Fact

  
Signature of Attorney-in-Fact

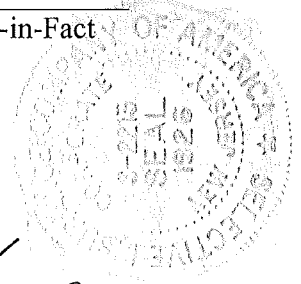

Debbie M. Welch  
Signature of Witness

Debbie M. Welch  
Print or type Signer's name

PO BOX 489 FAYETTEVILLE, NC 28302-0489  
Address of Attorney-in-Fact

Contract No.  
County

C203954  
Cumberland

Rev 2-1-10

**CONTRACT PAYMENT BOND**

**BondNo.B 1183071**

**CORPORATION**

SIGNATURE OF CONTRACTOR (Principal)

Fulcher Electric of Fayetteville, Inc.

Full name of Corporation

1744 Middle River loop Fayetteville, NC 28312

Address as prequalified

By

Kenneth L. Fulcher

Signature of ~~President~~, Vice President, ~~Assistant Vice President~~

Select appropriate title

Kenneth L. Fulcher

Print or type Signer's name

*Affix Corporate Seal*

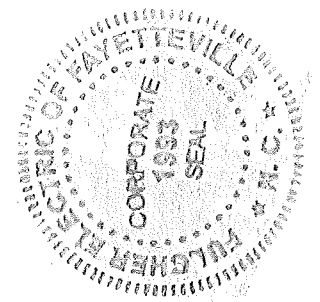

Attest

L. A. Fulcher

Signature of Secretary, ~~Assistant Secretary~~

Select appropriate title

Louis A. Fulcher, IV

Print or type Signer's name





Selective Insurance Company of America  
 40 Wantage Avenue  
 Branchville, New Jersey 07890  
 973-948-3000

BondNo.B 1183071

**POWER OF ATTORNEY**

Class A-1 Performance Bond

**SELECTIVE INSURANCE COMPANY OF AMERICA**, a New Jersey corporation having its principal office at 40 Wantage Avenue, in Branchville, State of New Jersey ("SICA"), pursuant to Article VII, Section 1 of its By-Laws, which state in pertinent part:

The Chairman of the Board, President, Chief Executive Officer, any Executive Vice President, any Senior Vice President or any Corporate Secretary may, from time to time, appoint attorneys in fact, and agents to act for and on behalf of the Corporation and they may give such appointee such authority, as his/her certificate of authority may prescribe, to sign with the Corporation's name and seal with the Corporation's seal, bonds, recognizances, contracts of indemnity and other writings obligatory in the nature of a bond, recognizance or conditional undertaking, and any of said Officers may, at any time, remove any such appointee and revoke the power and authority given him/her.

does hereby appoint **Robert Lamarr Johnson**

, its true and lawful attorney(s)-in-fact, full authority to execute on SICA's behalf fidelity and surety bonds or undertakings and other documents of a similar character issued by SICA in the course of its business, and to bind SICA thereby as fully as if such instruments had been duly executed by SICA's regularly elected officers at its principal office, in amounts or penalties not exceeding the sum of: **Six Million Four Hundred Twenty Eight Thousand One Hundred Ninety Two Dollars (\$6,428,192.00)**

Signed this 10th day of March, 2017

SELECTIVE INSURANCE COMPANY OF AMERICA

By:

Brian C. Sarisky  
 Its SVP, Strategic Business Units, Commercial Lines



CERTIFIED COPY

STATE OF NEW JERSEY :

:ss. Branchville

COUNTY OF SUSSEX :

On this 10th day of March, 2017 before me, the undersigned officer, personally appeared Brian C. Sarisky, who acknowledged himself to be the Sr. Vice President of SICA, and that he, as such Sr. Vice President, being authorized so to do, executed the foregoing instrument for the purposes therein contained, by signing the name of the corporation by himself as Sr. Vice President and that the same was his free act and deed and the free act and deed of SICA.

**Charlene Kimble**  
 Notary Public of New Jersey  
 My Commission Expires 6/2/2021

Notary Public

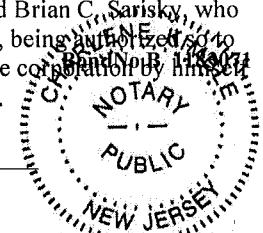

The power of attorney is signed and sealed by facsimile under and by the authority of the following Resolution adopted by the Board of Directors of SICA at a meeting duly called and held on the 6th of February 1987, to wit:

"RESOLVED, the Board of Directors of Selective Insurance Company of America authorizes and approves the use of a facsimile corporate seal, facsimile signatures of corporate officers and notarial acknowledgements thereof on powers of attorney for the execution of bonds, recognizances, contracts of indemnity and other writing obligatory in the nature of a bond, recognizance or conditional undertaking."

**CERTIFICATION**

I do hereby certify as SICA's Corporate Secretary that the foregoing extract of SICA's By-Laws and Resolution is in full force and effect and this Power of Attorney issued pursuant to and in accordance with the By-Laws is valid.

Signed this 10th day of March, 2017

Michael H. Lanza, SICA Corporate Secretary



Important Notice: If the bond number embedded within the Notary Seal does not match the number in the upper right-hand corner of this Power of Attorney, contact us at 973-948-3000.

Contract No.  
County

C203954  
Cumberland

Rev 2-1-10

**BondNo.B 1183071**

### CONTRACT PERFORMANCE BOND

Date of Performance Bond Execution: March 10, 2017

Name of Principal Contractor: Fulcher Electric of Fayetteville, Inc.

Name of Surety: Selective Insurance Company of America

Name of Contracting Body: North Carolina Department of Transportation  
Raleigh, North Carolina

Amount of Bond: 6428192.00

Contract ID No.: C203954, Fayetteville, Cumberland Co

County Name: \_\_\_\_\_

KNOW ALL MEN BY THESE PRESENTS, That we, the PRINCIPAL CONTRACTOR (hereafter, PRINCIPAL) and SURETY above named, are held and firmly bound unto the above named Contracting Body, hereinafter called the Contracting Body, in the penal sum of the amount stated above for the payment of which sum well and truly to be made, we bind ourselves, our heirs, executors, administrators, and successors, jointly and severally, firmly by these presents.

THE CONDITION OF THIS OBLIGATION IS SUCH, that whereas the principal entered into a certain contract with the Contracting Body, numbered as shown above and hereto attached:

NOW THEREFORE, if the principal shall well and truly perform and fulfill all the undertakings, covenants, terms, conditions, and agreements of said contract during the original term of said contract and any extensions thereof that may be granted by the Contracting Body, with or without notice to the Surety, and during the life of any guaranty required under the contract, and shall also well and truly perform and fulfill all the undertakings, covenants, terms, conditions, and agreements of any and all duly authorized modifications of said contract that may hereafter be made, notice of which modifications to the surety being hereby waived, then this obligation to be void; otherwise to remain in full force and virtue.

IN WITNESS WHEREOF, the above-bound parties have executed this instrument under their several seals on the date indicated above, the name and corporate seal of each corporate party being hereto affixed and these presents duly signed by its undersigned representative, pursuant to authority of its governing body.

Contract No.  
County

C203954  
Cumberland

Rev 2-1-10

BondNo.B 1183071

**CONTRACT PERFORMANCE BOND**

*Affix Seal of Surety Company*

Selective Insurance Company of America  
Print or type Surety Company Name

By Robert Lamarr Johnson, Attorney-in-Fact  
Print, stamp or type name of Attorney-in-Fact

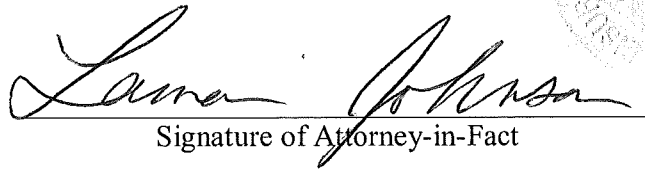
  
Signature of Attorney-in-Fact

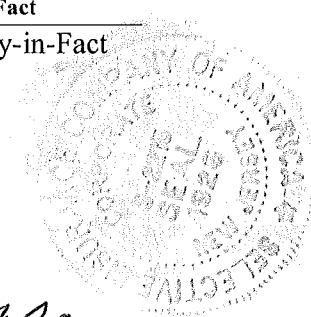

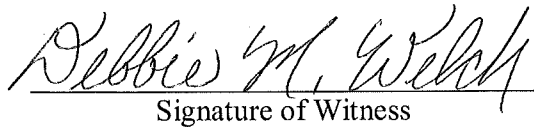
  
Signature of Witness

Debbie M. Welch  
Print or type Signer's name

PO BOX 489 FAYETTEVILLE, NC 28302-0489  
Address of Attorney-in-Fact

Contract No. C203954  
County Cumberland

Rev 2-1-10

BondNo.B 1183071

**CONTRACT PERFORMANCE BOND**

**CORPORATION**

SIGNATURE OF CONTRACTOR (Principal)

**Fulcher Electric of Fayetteville, Inc.**  
\_\_\_\_\_  
Full name of Corporation

**1744 Middle River loop Fayetteville, NC 28312**  
\_\_\_\_\_  
Address as prequalified

By *Kenneth L. Fulcher*  
Signature of ~~President~~, Vice President, ~~Assistant Vice President~~  
Select appropriate title

**Kenneth L. Fulcher**  
\_\_\_\_\_  
Print or type Signer's name

*Affix Corporate Seal*



Attest *Louis A. Fulcher, IV*  
Signature of Secretary, ~~Assistant Secretary~~  
Select appropriate title

**Louis A. Fulcher, IV**  
\_\_\_\_\_  
Print or type Signer's name

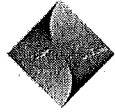

SELECTIVE®

Selective Insurance Company of America
40 Wantage Avenue
Branchville, New Jersey 07890
973-948-3000

BondNo.B 1183071

POWER OF ATTORNEY

Class A-1 Performance Bond

SELECTIVE INSURANCE COMPANY OF AMERICA, a New Jersey corporation having its principal office at 40 Wantage Avenue, in Branchville, State of New Jersey ("SICA"), pursuant to Article VII, Section 1 of its By-Laws, which state in pertinent part:

The Chairman of the Board, President, Chief Executive Officer, any Executive Vice President, any Senior Vice President or any Corporate Secretary may, from time to time, appoint attorneys in fact, and agents to act for and on behalf of the Corporation and they may give such appointee such authority, as his/her certificate of authority may prescribe, to sign with the Corporation's name and seal with the Corporation's seal, bonds, recognizances, contracts of indemnity and other writings obligatory in the nature of a bond, recognizance or conditional undertaking, and any of said Officers may, at any time, remove any such appointee and revoke the power and authority given him/her.

does hereby appoint Robert Lamarr Johnson

, its true and lawful attorney(s)-in-fact, full authority to execute on SICA's behalf fidelity and surety bonds or undertakings and other documents of a similar character issued by SICA in the course of its business, and to bind SICA thereby as fully as if such instruments had been duly executed by SICA's regularly elected officers at its principal office, in amounts or penalties not exceeding the sum of: Six Million Four Hundred Twenty Eight Thousand One Hundred Ninety Two Dollars (\$6,428,192.00)

Signed this 10th day of March, 2017

SELECTIVE INSURANCE COMPANY OF AMERICA

By: [Signature]
Brian C. Sarisky
Its SVP, Strategic Business Units, Commercial Lines



CERTIFIED COPY

STATE OF NEW JERSEY :
:ss. Branchville
COUNTY OF SUSSEX :

On this 10th day of March, 2017 before me, the undersigned officer, personally appeared Brian C. Sarisky, who acknowledged himself to be the Sr. Vice President of SICA, and that he, as such Sr. Vice President, being authorized to do, executed the foregoing instrument for the purposes therein contained, by signing the name of the corporation by himself as Sr. Vice President and that the same was his free act and deed and the free act and deed of SICA.

Charlene Kimble
Notary Public of New Jersey
My Commission Expires 6/2/2021

[Signature]
Notary Public

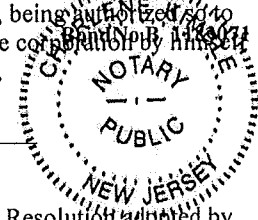

The power of attorney is signed and sealed by facsimile under and by the authority of the following Resolution adopted by the Board of Directors of SICA at a meeting duly called and held on the 6th of February 1987, to wit:

"RESOLVED, the Board of Directors of Selective Insurance Company of America authorizes and approves the use of a facsimile corporate seal, facsimile signatures of corporate officers and notarial acknowledgements thereof on powers of attorney for the execution of bonds, recognizances, contracts of indemnity and other writing obligatory in the nature of a bond, recognizance or conditional undertaking."

CERTIFICATION

I do hereby certify as SICA's Corporate Secretary that the foregoing extract of SICA's By-Laws and Resolution in full force and effect and this Power of Attorney issued pursuant to and in accordance with the By-Laws is valid.

Signed this 10th day of March, 2017

[Signature]
Michael H. Lanza, SICA Corporate Secretary



Important Notice: If the bond number embedded within the Notary Seal does not match the number in the upper right-hand corner of this Power of Attorney, contact us at 973-948-3000.



Selective Insurance Company of America  
 40 Wantage Avenue  
 Branchville, New Jersey 07890  
 973-948-3000

BondNo.B 1183071

**STATEMENT OF FINANCIAL CONDITION**

**Class A-1 Performance Bond**

I hereby certify that the following information is contained in the Annual Statement of Selective Insurance Company of America ("SICA") to the New Jersey Department of Banking and Insurance as of December 31, 2016:

<u>ADMITTED ASSETS (in thousands)</u>		<u>LIABILITIES AND SURPLUS (in thousands)</u>	
Bonds	\$1,517,188	Reserve for losses and loss expenses	\$980,125
Preferred stocks at convention value	3,960	Reserve for unearned premiums	357,292
Common stocks at convention values	85,162	Provision for unauthorized reinsurance	803
Subsidiary common stock at convention values	0	Commissions payable and contingent commissions	29,684
Short-term investments	86,071	Other accrued expenses	25,337
Mortgage loans on real estate (including collateral loans)	34,324	Other liabilities	<u>352,332</u>
Other invested assets	70,422	Total liabilities	1,745,573
Interest and dividends due or accrued	14,989		
Premiums receivable	336,651	Surplus as regards policyholders	<u>568,591</u>
Other admitted assets	<u>165,397</u>		
Total admitted assets	<u>2,314,164</u>	Total liabilities and surplus as regards policyholders	<u>2,314,164</u>

I further certify that the following is a true and exact excerpt from Article VII, Section 1 of the By-Laws of SICA, which is still valid and existing.

The Chairman of the Board, President, Chief Executive Officer, any Executive Vice President, any Senior Vice President or any Corporate Secretary may, from time to time, appoint attorneys in fact, and agents to act for and on behalf of the Corporation and they may give such appointee such authority, as his/her certificate of authority may prescribe, to sign with the Corporation's name and seal with the Corporation's seal, bonds, recognizances, contracts of indemnity and other writings obligatory in the nature of a bond, recognizance or conditional undertaking, and any of said Officers may, at any time, remove any such appointee and revoke the power and authority given him/her.

IN WITNESS WHEREOF, I hereunto subscribe my name and affix the seal of SICA this 22 day of February 2017.

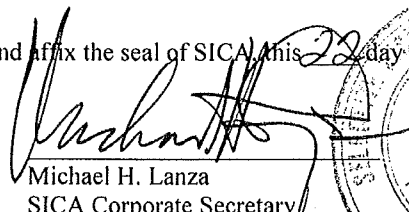
  
 Michael H. Lanza  
 SICA Corporate Secretary

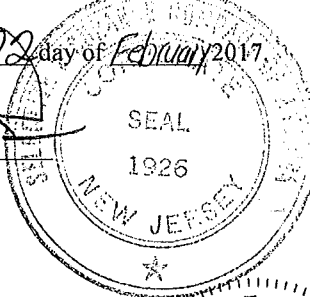

STATE OF NEW JERSEY :  
 :ss. Branchville  
 COUNTY OF SUSSEX :

On this 22 day of February 2017, before me, the undersigned officer, personally appeared Michael H. Lanza, who acknowledged himself to be the Corporate Secretary of SICA, and that he, as such Corporate Secretary, being authorized so to do, executed the foregoing instrument for the purposes therein contained, by signing the name of the corporation by himself as Corporate Secretary.

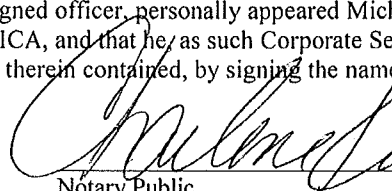
  
 Notary Public  
 My Commission Expires: \_\_\_\_\_

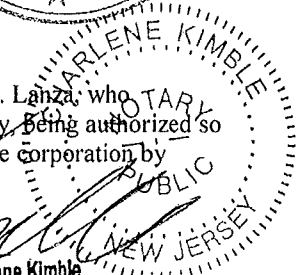

Charlene Kimble  
 Notary Public of New Jersey  
 My Commission Expires 6/2/2021